



UNIVERSA
UNIVERSIS
PATAVINA
LIBERTAS

UNIVERSITÀ DEGLI STUDI DI PADOVA

DIPARTIMENTO DI INGEGNERIA CIVILE, EDILE E AMBIENTALE
Laboratorio Sperimentale per le Prove sui Materiali da Costruzione
DEPARTMENT OF CIVIL, ENVIRONMENTAL AND ARCHITECTURAL ENGINEERING
Building materials testing Laboratory

Sede: via Marzolo n. 11/A - 35131 PADOVA
Segreteria: +39.049.827.5607

Fax: +39.049.827.5587
e-mail: lab.materiali@dicea.unipd.it

TEST REPORT N. 34744

Page 1/2

Applicant: Eterno Ivica S.r.l., via Austria Z.I. n. 25/E - Padova

Application: Received at 29/06/2012

Material: 3 samples of pedestal "ETERNO SE1" series, received at 29/06/2012

Required test: Measure the maximum compressive eccentric load of the specimen and the displacement of the testing machine's crossbar.

Testing method: The compression tests were made for all the 3 samples. The components of the pedestal had been assembled and the four tabs removed, the height of pedestal was regulated to the medium stroke of the screw (43.8 mm).
Testing speed set to 10 mm/min (checking movement of moving crossbar of the universal testing machine Galdabini, type Sun/60, with a load capacity of 600 kN).
The load applied with hardened steel plate on the base of specimen and a steel rectangular prism on the top of the pedestal with an eccentricity of 27.5 mm.
The values of maximum load (F_{max}) are the values of load at first failure/rupture.
The testing machine's certificate of calibration is n°036-12F about Calibration centre LAT n° 34 with due data January 19th, 2013.
Test activities were carried out on October 15th, 2012.
For any technical and dimensional detail, assembling scheme and any other information not included in this document, brochures and technical data sheets are at Applicant's disposal.

Test Result

Specimen	Max Load F_{max} [kN]	Stroke at F_{max} [mm]
1	10.88	6.0
2	12.39	5.9
3	11.21	5.8

Padova, November 28th, 2012

Laboratory Chief
(Prof. **Claudio Modena**)

Department Chief
(Prof. **Carmelo Majorana**)



UNIVERSA
UNIVERSIS
PATAVINA
LIBERTAS

UNIVERSITÀ DEGLI STUDI DI PADOVA

DIPARTIMENTO DI INGEGNERIA CIVILE, EDILE E AMBIENTALE
Laboratorio Sperimentale per le Prove sui Materiali da Costruzione
DEPARTMENT OF CIVIL, ENVIRONMENTAL AND ARCHITECTURAL ENGINEERING
Building materials testing Laboratory

Sede: via Marzolo n. 11/A - 35131 PADOVA
Segreteria: +39.049.827.5607

Fax: +39.049.827.5587
e-mail: lab.materiali@dicea.unipd.it

TEST REPORT N. 34744

Page 2/2

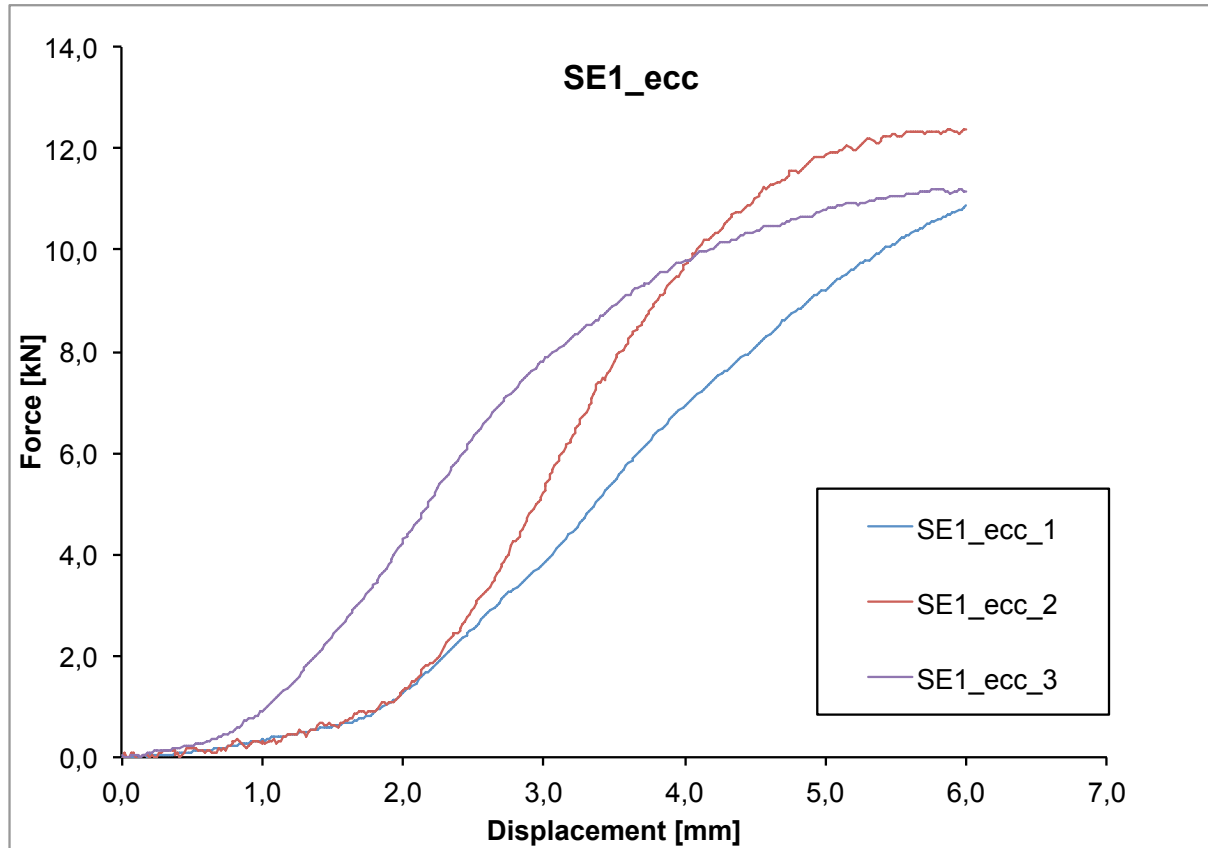

Figure 1 Diagram force versus displacement of testing machine's crossbar for "ETERNO SE1" specimen.

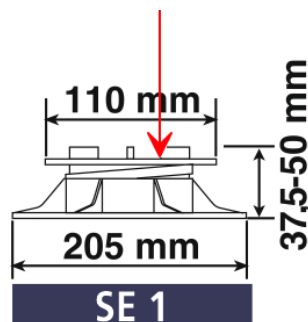

Figure 2 Typical "ETERNO SE1" specimen.

The annex A (report n. 35342) contains explanation about specimens.

Padova, November 28th, 2012

Laboratory Chief
(Prof. **Claudio Modena**)

Department Chief
(Prof. **Carmelo Majorana**)