

eternoivica

I N N O V A T I O N L E A D E R

Catalogo
Catalog

2024
IT | EN



PEDESTAL

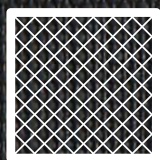

GRF



WOODECK

The outdoor raised floor specialists

eternoivica

I N N O V A T I O N L E A D E R

Catalogo generale

General Catalogue

always one step ahead

Indice

Il sopraelevato | Raised floor

6

Innovation leader: da oltre 68 anni una visione globale <i>Innovation leader: for over 68 years, a global vision</i>	7
L'arte dell'eccellenza produttiva in Italia <i>The art of production excellence in Italy</i>	9
La foresta di Eterno Ivica <i>The Eterno Ivica forest</i>	11
La qualità non è un'opinione <i>The quality is not an opinion</i>	13
La Storia insegna <i>Lessons from the past</i>	14
Il sopraelevato: la soluzione definitiva <i>Raised floor: the ultimate solution</i>	16
Vantaggi del pavimento sopraelevato <i>Advantages of the raised floor</i>	18
Impieghi <i>Uses</i>	22
Pavimento incollato vs. Pavimento sopraelevato <i>Glued floor vs. Raised floor</i>	24
Una soluzione, tre tipologie di posa <i>One solution, three types of installation</i>	26

Supporti | Supports

28

Supporti regolabili in altezza <i>Adjustable height supports</i>	30
Supporti ad altezza fissa (non regolabili) <i>Fixed height supports (not adjustable)</i>	31
Base a rottura facilitata <i>Easy-break base</i>	32
Testa bicomponente PP + gomma <i>Two-component PP + rubber head</i>	34
Testa bicomponente fissa o autolivellante <i>Fixed or self-leveling two-component head</i>	36
Blocco testa basculante per supporti PR e SE <i>Locking system for PR and SE supports</i>	38
Accessorio per rendere la testa basculante per supporto SR/SRT <i>Accessory to make the head tilting for SR/SRT supports</i>	38
Guida alla scelta dei supporti <i>Guide to the choice of supports</i>	40
Caratteristiche <i>Features</i>	41

Supporti regolabili | Adjustable supports

46

PR Supporto Pedestal Prime® PR Pedestal Prime® support	48
SR/SRT Supporto Reversus® SR/SRT Reversus® support	64
SE Supporto Eterno SE Eterno support	74
NM Supporto New Maxi NM New Maxi support	88
SB Supporto Basic SB Basic support	102
Star.T Supporto Star.T Star.T Star.T support	112

Supporti altezza fissa | Fixed height supports

124

EH Rubber 10+6	126
EH 12 15 20	130
DM Distanziatore mini sabbia/erba/ghiaia DM Mini spacer for sand/grass/gravel	134
CR Crocette sabbia/erba/ghiaia CR Cross spacer for sand/grass/gravel	135

Index

Supporti speciali | Special supports

136

PR W Pedestal Prime® antivento PR W Pedestal Prime® windproof system	139
SE W Eterno antivento SE W Eterno windproof system	140
NM W New Maxi antivento NM W New Maxi support windproof system	141
PR S Pedestal Prime® Silent PR S Pedestal Prime® Silent	144
SR/SRT S Reversus® Silent SR/SRT S Reversus® Silent	145
SE S Eterno Silent SE S Eterno Silent	146
NM S New Maxi Silent NM S New Maxi Silent support	147

Supporti autoestinguenti | VO self-extinguishing supports

150

PR VO Supporto Pedestal Prime® autoestinguente PR VO VO self-extinguishing Pedestal Prime®	152
SE VO Supporto Eterno autoestinguente SE VO VO self-extinguishing Eterno support	154
NM VO Supporto New Maxi autoestinguente NM VO VO self-extinguishing New Maxi support	155
Star.T VO Supporto Star.T autoestinguente Star.T VO VO self-extinguishing Star.T support	156
EH VO Supporto EH autoestinguente EH VO VO self-extinguishing EH support	157

Supporti di metallo | Metal supports

158

SMA Supporto metallico classe A1 SMA Metal support A1 fire rated	160
SMAT Supporto metallico classe A1 SMAT Metal support A1 fire rated	162
Strato separatore in acciaio zincato classe A1 Galvanized steel separator layer A1 fire rated	164

Accessori | Accessories

166

Chiave di regolazione e accessorio per avvitatore Adjustment key and screwdriver accessory	168
Maniglia posa lastre Slab lifting handle	170
Ventosa alza lastre Suction cup slab lifter	170
Alza lastra Slab lifter	171
Distanziatore perimetrale Perimeter spacer	172
Scudo Scudo	174
Strato separatore in gomma Supplementary rubber base	175
Base di cemento Concrete base	176
Livellatore per la posa delle piastrelle incollate Tile leveling system	178

Indice

Pedestal System

182

Perché utilizzare Pedestal System? <i>Why use Pedestal System?</i>	186
Gli elementi del sistema Pedestal <i>The elements of Pedestal System</i>	188
Posa Pedestal con ceramica <i>Laying Pedestal with ceramic slabs</i>	189
Consumo dei supporti al metro quadro <i>Support consumption per square meter</i>	190
Schemi di montaggio <i>Assembly diagrams</i>	192
Piastra di sicurezza <i>Safety plate</i>	194
Livellatori in gomma <i>Rubber shims</i>	195
Compensatore di pendenza <i>Slope compensator</i>	196
Profilo bordo lastra <i>Slab edge profile</i>	198
Profilo perimetrale verticale <i>Vertical perimeter profile</i>	199
Clip tamponamento verticale <i>Vertical lining clip</i>	202
Clip tamponamento verticale angolare <i>Vertical angular lining clip</i>	204
Clip lastre esagonali <i>Clip for hexagonal slabs</i>	206
Accessorio per aumentare lo spessore delle alette <i>Tool to increase the thickness of the tabs</i>	207

GRF – Grid Raised Floor System

208

Perché utilizzare GRF System? <i>Why use GRF System?</i>	212
Posa GRF System con ceramica <i>Laying GRF System with ceramic slabs</i>	213
Posa GRF System con erba sintetica <i>Laying GRF System with synthetic grass</i>	214
Posa mista ceramica ed erba sintetica <i>Mixed installation of ceramic slabs and synthetic grass</i>	214
Lo speciale innesto "a coda di rondine" <i>The special "dovetail" joint</i>	216
Gli elementi del sistema GRF <i>The elements of GRF System</i>	217
Griglia <i>Grid</i>	218
Distanziatore DLG <i>DLG spacer</i>	219
Consumo dei distanziatori DLG al metro quadro <i>DLG spacers consumption per square meter</i>	220
Consumo dei supporti al metro quadro <i>Consumption of supports per square meter</i>	220
Profilo bordo lastra <i>Slab edge profile</i>	222
Profilo perimetrale verticale <i>Vertical perimeter profile</i>	223
Clip tamponamento verticale (base) <i>Vertical lining clip (base)</i>	226
Clip tamponamento verticale angolare (base) <i>Vertical angular lining clip (base)</i>	228
Profilo separatore a "T" <i>"T" separator profile</i>	229
Rotolo di erba sintetica <i>Synthetic grass</i>	230
Banda di giunzione adesiva <i>Adhesive joining tape</i>	230
Sabbia silicea <i>Silica sand</i>	230

Woodeck System

232

Perché utilizzare Woodeck System? <i>Why use Woodeck System?</i>	234
Tipologie di testa per Woodeck System <i>Types of head for Woodeck System</i>	236
Testa per travetto in alluminio <i>Head for aluminium joist</i>	237
Testa per travetto in legno <i>Universal head for decking</i>	237
Testa reversibile per travetto in alluminio e legno (Reversus®) <i>Reversible head for aluminium/wood joist (Reversus®)</i>	237
Testa a incrocio per travetti in alluminio <i>Criss-cross head for aluminium joists</i>	238
Gli elementi del sistema Woodeck <i>The elements of Woodeck System</i>	242
Posa Woodeck con ceramica, legno e/o WPC <i>Laying Woodeck with ceramic slabs, WPC and wooden planks</i>	243

Index

Guida all'utilizzo dei travetti in alluminio <i>Guide to using aluminum joists</i>	244
Come calcolare il consumo di travetti, supporti e clip per la posa di lastre in ceramica mono e multiformato <i>How to calculate the use of joists, supports and clips for laying single and multi-format ceramic slabs</i>	246
Schemi di montaggio per la posa di lastre in ceramica mono e multiformato <i>Single and multi-format ceramic slabs assembly diagrams</i>	248
Come calcolare il consumo di travetti, supporti e clip per la posa di listoni in ceramica <i>How to calculate the use of joists, supports and clips for laying ceramic planks</i>	250
Schemi di montaggio per la posa di listoni in ceramica <i>Assembly diagrams of ceramic planks</i>	252
Come calcolare il consumo di travetti, supporti e clip per la posa di listoni in legno/WPC <i>How to calculate the use of joists, supports and clips for laying wooden/WPC planks</i>	254
Compatibilità accessori <i>Accessories compatibility</i>	256
Travetto in alluminio standard <i>Standard aluminium joist</i>	258
Travetto in alluminio a deflusso rapido <i>Aluminium joist for rapid flow</i>	259
Travetto in alluminio ECO standard <i>Aluminium ECO standard joist</i>	260
Travetto in alluminio ECO a deflusso rapido <i>Aluminium ECO joist for rapid flow</i>	261
Giunto per travetto in alluminio standard <i>Standard aluminium joist joint</i>	262
Giunto per travetto in alluminio a deflusso rapido - ECO standard - ECO a deflusso rapido <i>Rapid flow, ECO standard and ECO for rapid flow aluminium joist joint</i>	262
Gomma anti rumore <i>Noise insulating rubber</i>	263
Guarnizione in PVC <i>PVC gasket</i>	263
Distanziatore (clip) a croce con alette 4 mm H 12 mm <i>Slab spacers for aluminium joist - 4 mm thick, H 12 mm tabs</i>	264
Clip di testa con vite di fissaggio <i>Head clip with fixing screw</i>	266
Clip singola <i>Single clip</i>	266
Clip doppia <i>Double clip</i>	268
Clip doppia con doppia vite di fissaggio <i>Double clip with fixing screws</i>	270
Clip tamponamento verticale per posa lastre in ceramica monoformato, multiformato e listoni in ceramica <i>Vertical lining clip for laying mono, multi-size ceramic slabs and planks</i>	272
Clip tamponamento angolare per posa lastre in ceramica monoformato, multiformato e listoni in ceramica <i>Angular lining clip for laying mono, multi-size ceramic slabs and planks</i>	273
Clip tamponamento verticale per posa listoni in legno/WPC (decking) <i>Vertical lining clip for laying wooden/WPC planks (decking)</i>	274
Clip tamponamento verticale angolare per posa listoni in legno/WPC (decking) <i>Vertical angular lining clip for laying wooden/WPC planks (decking)</i>	275

Software, servizi e packaging | Software, services and packaging

276

Software di calcolo <i>Calculation software</i>	278
Formazione <i>Training</i>	279
Assistenza in cantiere <i>Assistance on site</i>	280
Scuola di posa <i>Installation school</i>	281
Confezioni speciali personalizzate <i>Customized special packages</i>	282
Referenze <i>References</i>	284



Innovation leader: da oltre 68 anni una visione globale.

Innovation leader: for over 68
years, a global vision.



Guarda il video
corporate
Watch the
corporate video



Eterno Ivica esporta in tutto il mondo l'alta qualità delle sue creazioni, contribuendo a diffondere l'eccellenza italiana oltre i confini nazionali. L'orizzonte e la visione di Eterno Ivica si spingono sempre più verso un mercato globale che abbraccia, ad ampio raggio, edilizia residenziale e commerciale.

Eterno Ivica exports the highest quality of its creations, helping to spread Italian excellence worldwide. The horizon and the Eterno Ivica vision pushes more and more towards a global market that embraces, wide-ranging, residential and commercial construction.

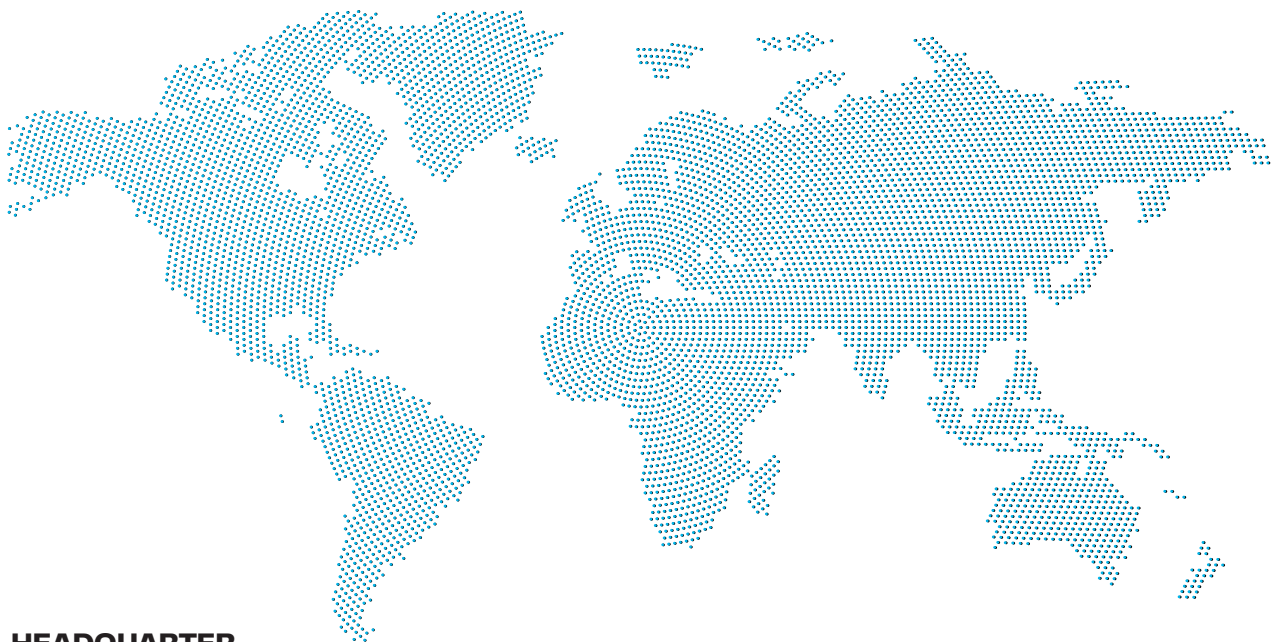

HEADQUARTER



Padova
Padua

FILIALI BRANCHES



Londra
London



Lione
Lyon



Zagabria
Zagreb

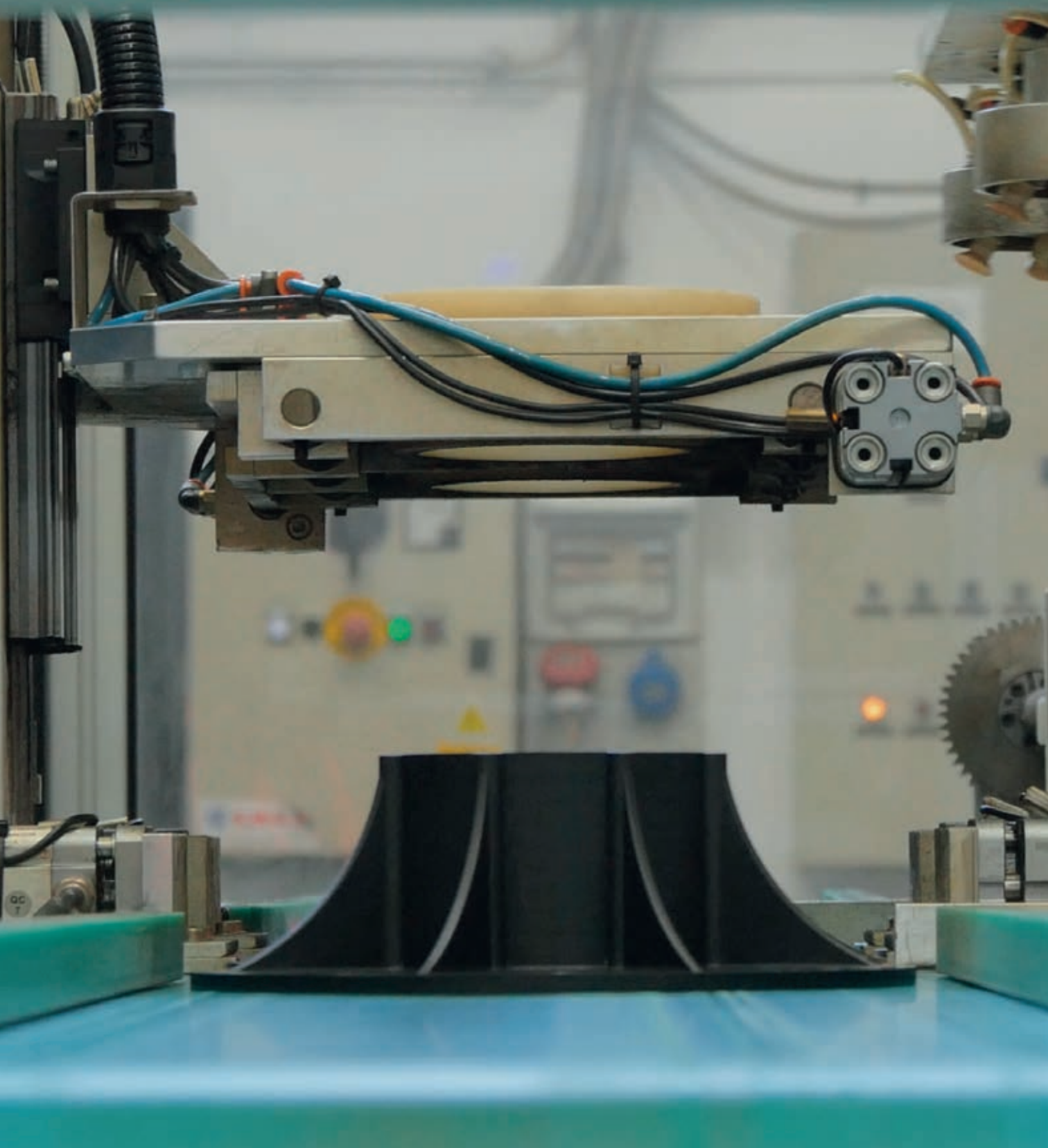

L'arte dell'eccellenza produttiva in Italia

The art of production excellence
in Italy.



Guarda il video
"Come è fatto?"
Watch the video
"How it's made?"



Tutti i prodotti Eterno Ivica sono progettati e interamente realizzati in Italia. Lo stile, il design, il gusto, la cura del dettaglio e l'eccellenza italiana contraddistinguono i nostri sistemi, apprezzati in tutto il mondo, distribuiti attraverso una rete di distributori ed agenti.

La produzione di Eterno Ivica è svolta internamente all'azienda, mediante 14 presse ad iniezione fino a 550 tonnellate, che lavorano a ciclo continuo, 6 giorni su 7. Il ciclo produttivo è completo, i prodotti escono pronti per la consegna.

All Eterno Ivica products are designed and manufactured entirely in Italy. Style, design, taste, attention to detail and Italian excellence distinguish our systems, appreciated throughout the world, marketed through a network of distributors and agents.

The production of Eterno Ivica is performed in-house, using 14 injection molding machines up to 550 tons, which work in a continuous process six days a week. The production cycle is complete, the products come out ready for delivery.

always one step ahead



1000+

ALBERI PIANTATI

TREES PLANTED

Se la tecnologia è il fine,
la sostenibilità è il mezzo
per raggiungerla:
non c'è l'uno senza l'altro.

If technology is the goal, the sustainability
it is the means to reach it: there is not one
without the other.





La foresta di Eterno Ivica

Eterno Ivica dà vita a una foresta per salvaguardare l'ambiente e ottimizzare il proprio impatto.

La scelta nasce dall'attenzione riposta nei progetti agroforestali di Treedom che favoriscono l'interazione virtuosa tra diverse specie ed un uso sostenibile delle risorse e dei terreni.

La nostra scelta avrà un impatto diretto sull'ambiente attraverso l'assorbimento di CO² e l'emissione di ossigeno. Contribuirà al contempo a realizzare ecosistemi sostenibili, permettendo ai contadini delle popolazioni di Cameroon, Colombia, Ghana, Kenya, Madagascar e Tanzania di far fronte ai costi iniziali della piantumazione degli alberi, garantendo sovranità alimentare e opportunità di reddito.

The Eterno Ivica forest

Eterno Ivica creates a forest to safeguard the environment and optimize its impact.

This choice stems from the attention given to the agroforestry projects of Treedom, which promote a virtuous interaction between different species and a sustainable use of resources and land.

Our choice will have a direct impact on the environment through the absorption of CO² and the release of oxygen. It will also contribute to creating sustainable ecosystems, enabling farmers in populations from Cameroon, Colombia, Ghana, Kenya, Madagascar, and Tanzania to cover the initial costs of tree planting, ensuring food sovereignty and income opportunities.



La qualità non è un'opinione

The quality is not an opinion

Qualità Quality

Gli obiettivi primari di Eterno Ivica sono garantire massima qualità, affidabilità e sicurezza.

L'impegno rivolto al conseguimento della qualità e al miglioramento continuo, il controllo costante sulle materie prime e i prodotti finiti sottoposti a specifici test, l'attenzione alla qualità dei processi e all'orientamento verso il cliente sono dimostrati dalla Certificazione ISO 9001:2008.

Eterno Ivica ha inoltre conseguito la Certificazione ISO 14001:2008 a dimostrazione del rispetto di tutti i requisiti normativi rilevanti per l'ambiente, l'ottimizzazione dei consumi energetici, l'utilizzo di materie prime non inquinanti e la gestione ottimale dello smaltimento dei rifiuti. Infine la Certificazione SA 8000 premia le politiche etiche orientate al rispetto dei diritti sociali in tutta la filiera produttiva.

Riciclabile Recyclable

L'attenzione all'ambiente da parte dell'azienda si traduce in risultati concreti. I prodotti Eterno Ivica sono realizzati infatti con materie prime completamente riciclabili, con impatto bassissimo sull'ambiente.

Inoltre tutti i supporti delle linee Pedestal, Woodeck e GRF System contribuiscono all'acquisizione di crediti LEED (The Leadership in Energy and Environmental Design).



Eterno Ivica's primary goals are to ensure highest quality, reliability, and safety.

The efforts aimed at achieving quality and continuous improvement, constant control on raw materials and finished products undergoing specific tests, attention to the quality of processes and the orientation towards the client are proven by the ISO Certification 9001: 2008.

Eterno Ivica has also obtained the ISO 14001: 2008 certification demonstrating compliance with all regulatory requirements relevant to the environment, the optimization of energy consumption, the use of raw materials not polluting and optimal management of waste disposal. Finally, the SA 8000 Certification rewards ethical policies oriented with respect for social rights in the entire production chain.



Attention to the environment by the company translates into concrete results. Eterno Ivica products of the line are made in fact with fully recyclable raw materials, with very low impact on the environment.

In addition, all the supports of the Pedestal, Woodeck, and GRF System product lines contribute to earning LEED (The Leadership in Energy and Environmental Design) credits.

always one step ahead

La Storia insegna

Lessons
from the past

Non solo rivestimenti.

Quando pensiamo al pavimento associamo subito l'idea ai rivestimenti incollati al massetto. Ma la storia insegna che già da secoli l'uomo si è dedicato alla ricerca di soluzioni alternative per realizzare pavimentazioni in grado di rispondere a problematiche non risolvibili mediante la semplice stesura dei rivestimenti.

Not only coverings.

When we think of the flooring we immediately associate the idea of coatings bonded to the substrate. But history has taught us that for centuries men have been devoted to finding alternative solutions for the implementation of flooring able to respond to problems not solved by simple coatings.





La tecnologia del pavimento sopraelevato infatti è **anti-chissima**, se ne ritrovano interessanti esempi fin dalle **civiltà etrusche e romane**. Sia all'esterno sia all'interno degli edifici la tecnica edilizia è chiamata a rispondere a numerose e importanti problematiche. Le pavimentazioni esterne sono esposte alle intemperie, perciò il **corretto e agevole smaltimento delle acque meteoriche** è fondamentale per evitare che l'acqua ristagni e che col passare del tempo si possano creare seri danni alle strutture. Inoltre, **l'esposizione diretta a temperature estreme** e ai **naturali sbalzi termici**, così come ai movimenti strutturali, crea **forti tensioni sui rivestimenti** che, se fissati rigidamente al suolo con una libertà minima di dilatazione, possono incorrere nella **formazione di crepe**.

Infine non bisogna dimenticare che eventi climatici estremi e violente raffiche di vento, mettono a dura prova la tenuta dei rivestimenti, richiedendo accorgimenti tecnici mirati a **garantire la massima stabilità e sicurezza**.

*The technology of the raised floor is in fact very old: there are several interesting examples **since the Etruscan and Roman civilizations**. Both indoors and outdoors of buildings, building technology is called to respond to numerous and important issues. External floors are exposed to bad weather, therefore the **correct and easy disposal of rainwater** is essential to prevent water from stagnating and create serious damage to the structures over time. Also, **direct exposure to extreme temperatures and natural temperature changes**, as well as to **structural movements**, creating **strong tensions in coatings**. If these are rigidly attached to the support with **minimum freedom to dilate**, they may crack.*

*Finally we must not forget that climate extremes and violent gusts of wind are events which surely test the coatings' sealing, requiring technical devices **designed to ensure maximum stability and safety**.*

Il sopraelevato: la soluzione definitiva

Raised floor: the ultimate solution

Semplice e flessibile per una posa rapida e sicura

La tecnologia del pavimento sopraelevato offre **risposte tangibili, efficaci, versatili e vantaggi immediatamente apprezzabili**: essa permette infatti una gestione semplice del passaggio di cavi, tubature e impianti, una rapida ispezionabilità del sottopavimento, un **efficace smaltimento delle acque meteoriche**.

I pavimenti sopraelevati, grazie alla presenza di elementi indipendenti, consentono di **assorbire le dilatazioni e i movimenti strutturali**, evitando così la formazione di crepe sul manto impermeabile. L'assenza del massetto permette quindi di **ridurre in modo sostanziale il peso** che grava sulle strutture, offrendo al contempo un'elevata resistenza ai carichi.

I sistemi Pedestal e Woodeck di Eterno Ivica, si spingono ancora oltre: grazie alla regolabilità dei supporti e degli accessori di compensazione, consentono di **ottenere pavimenti livellati, sempre in bolla**, compensando in modo semplice e veloce piccoli dislivelli e pendenze del piano di appoggio.

La posa in opera dei supporti Pedestal e Woodeck è estremamente facile e richiede pochissimi passaggi: i supporti sono concepiti per essere semplicemente appoggiati sopra la membrana impermeabilizzante o qualsiasi altra superficie destinata a essere pavimentata. Dopo una prima regolazione approssimativa, la posa della pavimentazione prescelta viene completata con precisione millimetrica tramite la chiave di regolazione anche a pavimento finito. L'innovativa testa bicomponente offre un esclusivo appoggio in morbida gomma anti-rumore e anti-scivolamento. Le alette sono asportabili con estrema facilità mentre la nuova base a rottura facilitata garantisce una posa semplice e veloce senza l'utilizzo di strumenti da taglio.

Simple and flexible for a quick and safe installation

*The technology of the raised floor **provides tangible answers, and effective, versatile and immediately appreciable benefits**: in fact, it allows easy **management of the cable duct, pipe and equipment**; quick inspection of the waterproofing; **effective drainage of water**.*

*Raised floors, thanks to the presence of independent elements, allow to **absorb the expansion and structural movements**, thus preventing the formation of cracks on the waterproofing. The absence of the screed allows to substantially **reduce the burden on the structures**, while providing a **high resistance to loads**.*

*The Pedestal and Woodeck systems by Eterno Ivica go even further: adjustable supports and compensation accessories allow to **achieve levelled floors, easily and quickly compensating** for even the smaller slopes of the support plane.*

*The installation of the Pedestal and Woodeck supports is extremely easy and requires **very few steps**: the supports are designed to be simply laid over the waterproofing membrane or any other surface to be paved. After a first rough adjustment, the laying of the chosen floor is completed with pinpoint precision by using the **adjustment key**, even after installation of the floor.*

The innovative two-component head provides exclusive support with soft anti-noise and anti-slip rubber padding. The tabs can be easily removed, the new easy-break base ensures a simple and quick installation without the use of cutting tools.

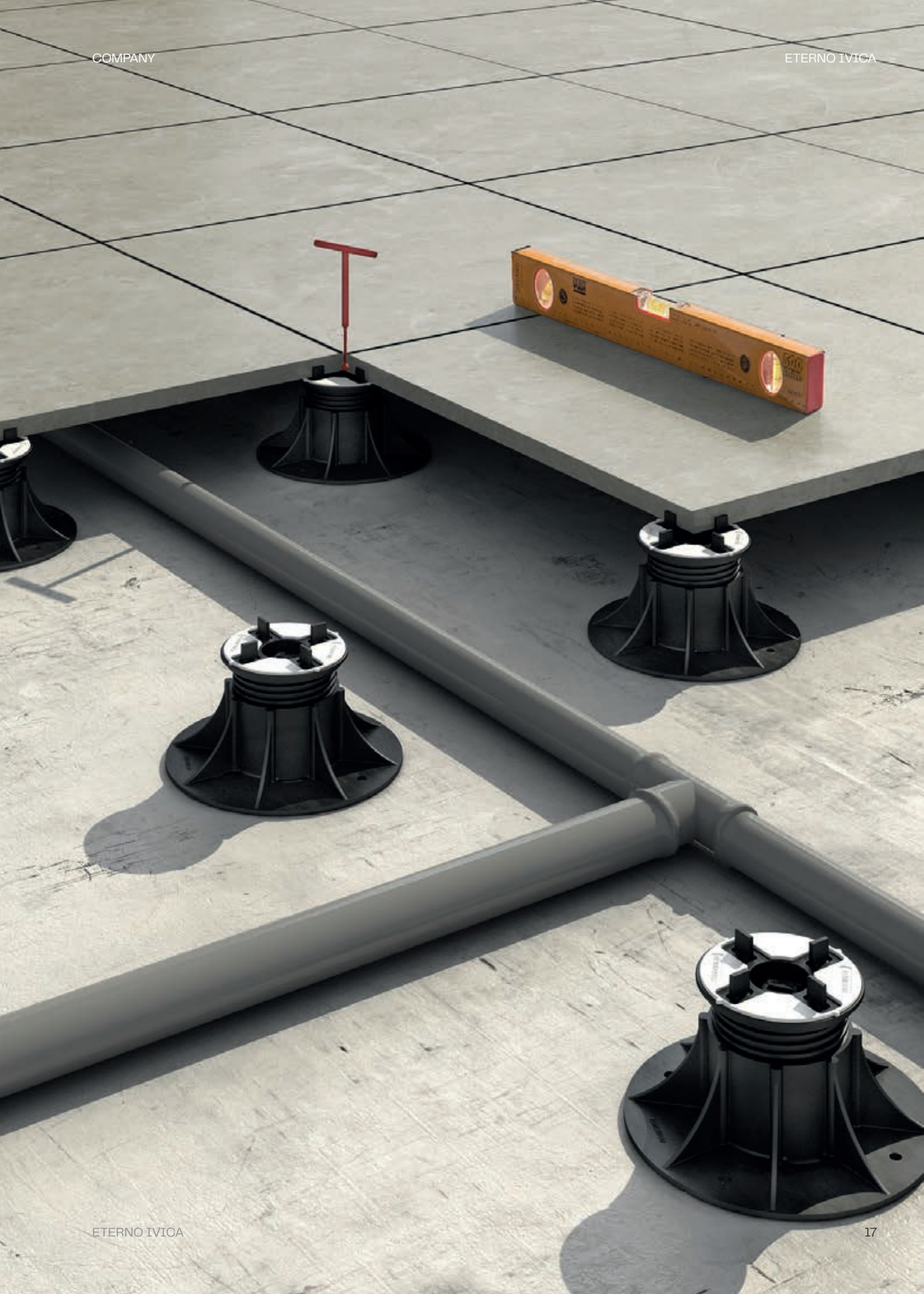

Vantaggi del pavimento sopraelevato



Ottimo nascondiglio per tubi ed impianti

L'intercapedine tra pavimentazione e membrana sottostante permette il passaggio di tubi e impianti che vengono così mascherati.

Great hiding place for pipes and fixtures

The gap between the flooring and the underlying membrane allows for the passage of pipes and systems which are therefore hidden.

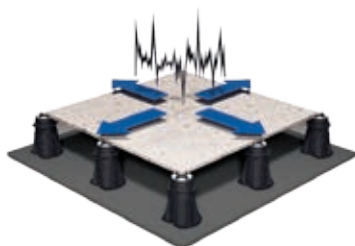

Ottimo assorbimento delle dilatazioni

L'indipendenza della pavimentazione e dei supporti di sostegno consente di assorbire le dilatazioni e i movimenti strutturali.

Excellent absorption of expansions

The independence of the flooring and the supports allows for the absorption of expansion and structural movements.



Pavimento sempre piano

Il sistema permette di compensare i piccoli dislivelli e le pendenze del piano di posa. In caso di posa su membrana impermeabilizzante, questa è facilmente ispezionabile data l'assenza di fissaggi meccanici fra il rivestimento e i supporti.

The floor is always flat

The system makes it possible to compensate for small unevenness and slopes of the laying surface. In the event of laying on a waterproof membrane, this can be easily inspected given the absence of mechanical fixed parts between the covering and the supports.

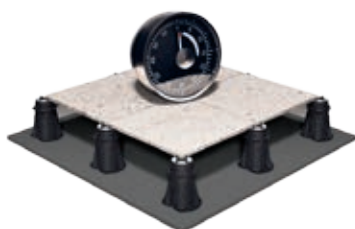

Velocità di posa in opera

La velocità di posa assicura notevoli vantaggi nella gestione del cantiere generando un risparmio economico; nel caso di ristrutturazioni il tempo di intervento limitato riduce i disagi per gli abitanti.

Speed of installation

The speed of installation ensures considerable advantages in site management, generating economic savings; in the event of renovations, the shorter needed time reduces any inconvenience for the people who live there.



Significativa diminuzione del peso

Con l'eliminazione del massetto di calcestruzzo, il sistema sopraelevato consente una diminuzione sostanziale del peso che grava sulla struttura.

Significant weight reduction

With the elimination of the concrete screed, the raised system allows for a substantial reduction in the weight that loads on the structure.

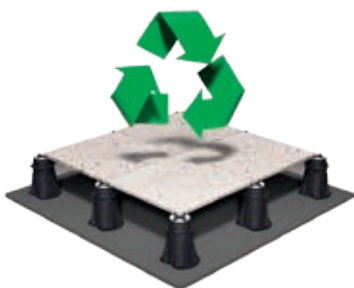

Ecologia e pulizia

Tutto è riciclabile, sia gli elementi di pavimentazione che la sottostruttura di supporto. A fine vita dell'edificio e/o del pavimento, tutto potrà essere agevolmente rimosso e riciclato senza impatto sull'ambiente. Il sistema di posa "a secco" non prevede collanti o prodotti chimici.

Ecology and cleanliness

Everything is recyclable, both the flooring elements and the supporting sub-structure. At the end of the life cycle of the building and/or the floor, everything can be easily removed and recycled without impacting the environment. The "dry" installation system does not require adhesives or chemicals.



Forte resistenza ai pesi

La robusta struttura del supporto conferita non solo dall'esperienza nel formulare il compound ma anche dalla filettatura continua tra base e vite, garantisce un prodotto forte, sicuro e duraturo.

Strong weight resistance

The sturdy structure of the support given by the experience in formulating the compound and also by the continuous thread between the base and the screw, guarantees a strong, safe and long-lasting product.

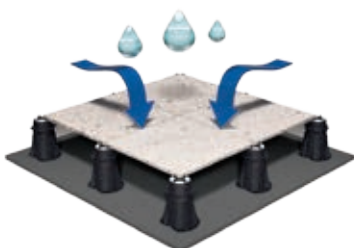

Rapido deflusso dell'acqua

La fuga tra una lastra e l'altra consente il rapido deflusso dell'acqua che viene convogliata tramite la pendenza sottostante.

Rapid outflow of water

The joint between one slab and another allows for the rapid drainage of the water, conveyed via the underlying slope.

Advantages of the raised floor

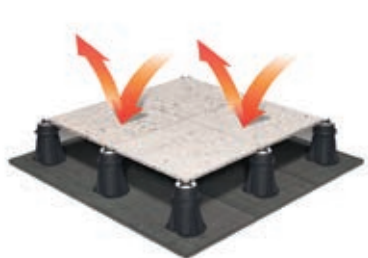

Protezione del manto impermeabile

Un pavimento sopraelevato posato su un tetto piano al di sopra del manto impermeabile ha la funzione di proteggere il manto stesso dalle intemperie e dai raggi UV, nell'intercapedine tra manto impermeabile e pavimento si crea una ventilazione naturale che preserva e allunga la vita del manto stesso.

Protection of the waterproof coat

A raised floor laid on a flat roof above the waterproof covering has the function of protecting the covering itself from inclement weather and UV rays, natural ventilation is created in the space between the waterproof covering and the floor which preserves and extends the life of the covering itself.



Durata della pavimentazione

Una pavimentazione sopraelevata resiste al 100% alle dilatazioni dovute dal cambio di temperatura e/o agli agenti atmosferici, a differenza delle tradizionali pavimentazioni incollate le quali dopo qualche anno iniziano a fessurarsi fino ad arrivare al distacco completo dal massetto.

Durability of the flooring

A raised floor is 100% resistant to expansion due to changes in temperature and/or atmospheric agents, unlike traditional glued floors which after a few years begin to crack until they are completely detached from the screed.



Miglior isolamento acustico

Grazie alla testa "two-component" anti scivolamento e anti rumore.

Better sound insulation

Obtained thanks to the "two-component" anti-slip and anti-noise head.



Migliore isolamento termico

L'intercapedine fra pavimentazione e membrana sottostante favorisce un costante passaggio d'aria con maggior durata dell'impermeabilizzazione.

Better thermal insulation

The cavity between the flooring and the underlying membrane favors a constant passage of air with a longer duration of the waterproofing.

Competenza, evoluzione e sviluppo non sono semplici parole, sono delle vere e proprie fondamenta su cui costruire la nostra unicità.

“Competence, evolution and development” are not simple words, they are real foundations on which we build our uniqueness.



Impieghi

Uses



Abitazioni civili tradizionali
Traditional civil houses



Abitazioni prefabbricate in CLS
Prefabricated houses in CLS



Abitazioni prefabbricate
in legno
Prefabricated homes Wood



Edifici industriali
Industrial buildings



Edifici del settore ricettivo
e alberghiero
Hospitality buildings and hotel



Uffici
Offices



Centri direzionali e commerciali
Business centers and commercial



Stand fieristici
Exhibition stands



Strutture prefabbricate
per manifestazioni
Prefabricated structures for events

La soluzione definitiva per molteplici campi d'applicazione

The definitive solution for multiple fields of application



Tetti piani
Flat roofs



Terrazze
Terraces



Giardini
Gardens



Zone gazebo
Gazebo areas



Bordi piscine
Poolside



Sottoportici esterni
External porches



Zone di camminamento
Walkways areas

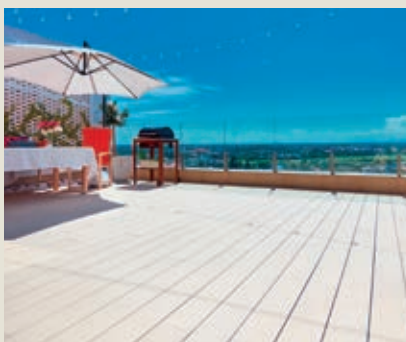

Zone esterne di bar e ristoranti
Outside bar areas and restaurants



Pavimentazioni provvisorie
Provisional Flooring

Pavimento incollato

Glued floor

Peso totale di massetto al di sopra del manto impermeabile = **149 kg per mq**
Total weight of screed above the waterproofing layer = 149 kg per square meter

Consumo di acqua per miscelare il massetto = **7,2 litri per mq**
Water consumption for mixing the screed = 7,2 liters per square meter

Tempo di stesura del massetto = **5 minuti per mq**
Screed application time = 5 minutes per square meter

Tempo di asciugatura e maturazione del massetto = **20 giorni**
Drying and curing time for the screed = 20 days

Tempo di attesa prima della posa del pavimento = **45/60 giorni**
Waiting time before floor installation = 45/60 days

Impermeabilizzazione massetto con membrana liquida, 2 mani con rete = **30 minuti per mq**
Waterproofing screed with liquid membrane, 2 coats with mesh = 30 minutes per square meter

Temperatura necessaria per incollaggio piastrelle = **da +5°C a +35°C**
Required temperature for tile adhesive = from +5°C a +35°C

Giunti di dilatazione = **devono essere previsti**
Expansion joints = need to be provided

Posa piastrelle con colla e stuccatura fughe = **25/30 minuti per mq**
Slab installation with adhesive and grout filling = 25/30 minutes per square meter

Tempo di attesa per stuccatura fughe = **48 ore**
Waiting time for grout filling = 48 hours

Messa in servizio del pavimento = **2/7 giorni**
Floor commissioning = 2/7 days

Pendenza = **1%-1,5%**
Slope = 1%-1,5%

0% accessibile. Gli impianti e/o il manto impermeabile si raggiungono solo distruggendo i massetti
0% accessible. The installations and/or the waterproofing layer can only be reached by destroying the screed

0% riutilizzabile. I massetti non possono essere riutilizzati altrove
0% reusable. Screeds cannot be reused elsewhere

0% riciclabile. I materiali di risulta dei massetti una volta distrutti vanno in discarica
0% recyclable. The waste materials from screed, once demolished, are taken to the landfill

NB: nella stagione invernale alcuni dati riferiti al pavimento incollato peggiorano notevolmente.
NB: in the winter season, some data related to the glued floor deteriorate significantly.



vs. Pavimento sopraelevato*

vs. Raised floor*

Non è necessario il massetto = **0 kg per mq**
No screed needed = 0 kg per square meter

Non vi è consumo di acqua = **0 litri per mq**
There is no water consumption = 0 liters per square meter

Tempo di posa dei supporti = **2 minuti per mq**
Installation time for supports = 2 minutes per square meter

No massetto = **0 giorni**
No screed = 0 days

Nessun tempo di attesa prima della posa del pavimento = **0 minuti per mq**
No waiting time before floor installation = 0 minutes per square meter

No massetto = No impermeabilizzazione = **0 minuti per mq**
No screed = No waterproofing = 0 minutes per square meter

La posa non è influenzata dalla temperatura
The installation is not influenced by the temperature

Giunti di dilatazione = **non sono necessari**
Expansion joints = not required

Posa lastre in ceramica spessore 20 mm compreso tagli = **15/20 minuti per mq**
Installation of 20mm thick ceramic slab including cuts = 15/20 minutes per square meter

No stuccatura fughe = **0 ore**
No grout filling = 0 hours

Messa in servizio del pavimento = **immediata = 0 giorni**
Floor commissioning = immediate = 0 days

Pendenza = **0%** = **Pavimento sempre in bolla**
Slope = 0% = Floor always level

100% accessibile. Gli impianti e/o il manto impermeabile si raggiungono semplicemente sollevando le lastre di ceramica
100% accessible. The installations and/or the waterproofing layer can be reached simply by lifting the ceramic slabs

100% riutilizzabile. I supporti e le lastre in ceramica sono completamente riutilizzabili
100% reusable. The supports and ceramic slabs are fully reusable

100% riciclabile. La materia prima dei supporti e i materiali di risulta delle lastre di ceramica sono completamente riciclabili
100% recyclable. The raw materials of the supports and the waste materials from ceramic slabs are entirely recyclable

* I dati presentati sono una stima e possono variare sulla base dei prodotti utilizzati e delle competenze del posatore.
 * The data presented is an estimate and may vary based on the products used and the skills of the installer.



Una soluzione, tre tipologie di posa

One solution,
three types of installation

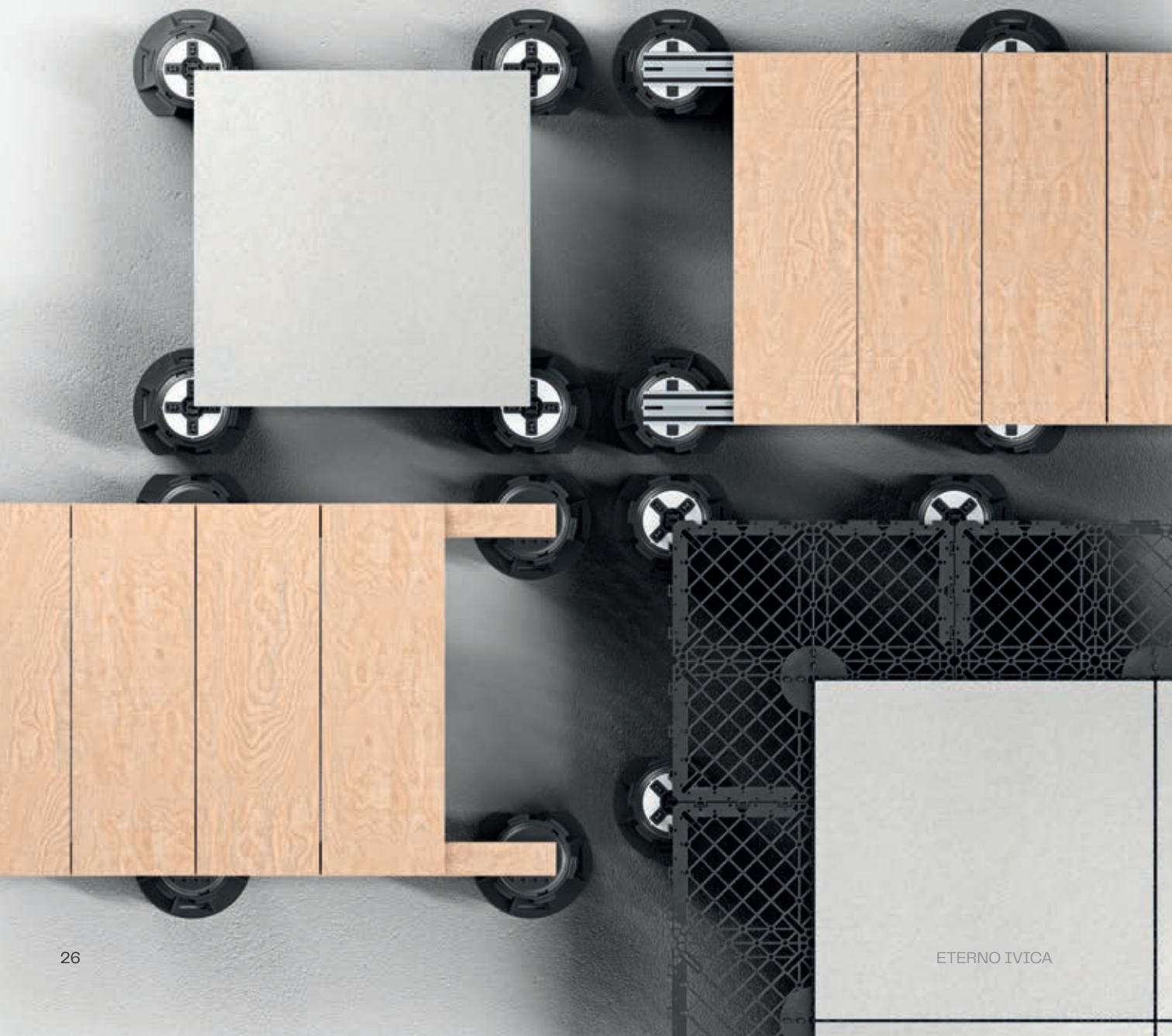



PEDESTAL SYSTEM

Posa di pavimentazioni sopraelevate direttamente sui supporti
Laying raised floor directly on the supports

Veloce, sicura e robusta: è la soluzione più rapida e semplice di Eterno Ivica per le pavimentazioni esterne sopraelevate. Prevede l'appoggio diretto delle lastre di ceramica sui supporti precedentemente posizionati a secco sul piano di posa.

Fast, safe, and sturdy: it is Eterno Ivica's quickest and simplest solution for raised outdoor floorings. It involves the direct laying of ceramic slabs on dry-laid supports on the installation surface.

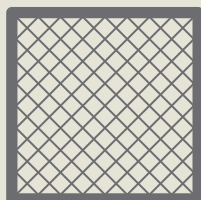

GRID RAISED FLOOR SYSTEM GRF

Posa di pavimentazioni sopraelevate su griglia
Laying raised floor on grid

NOVITÀ
NEWS

GRF System: la novità proposta da Eterno Ivica: la posa delle lastre di ceramica con la massima libertà possibile. Una volta creata la sottostruttura con le griglie è infatti possibile ogni tipologia di posa (a correre, diagonale, con cornice...).

L'altra grande novità prevede la posa di veri e propri tappeti green con erba sintetica, anche in abbinata a lastre di ceramica.

GRF System: the novelty proposed by Eterno Ivica: laying ceramic slabs with the utmost freedom possible. Once the substructure with grids is created, it is indeed possible to use any type of laying pattern (running bond, diagonal, with borders, etc.).

The other major innovation involves the installation of real green carpets with synthetic grass, even in combination with ceramic slabs.



WOODECK SYSTEM

Posa di pavimentazioni sopraelevate con travetto di alluminio o legno
Laying raised floor directly on the supports

La soluzione definitiva per la posa del pavimento sopraelevato su travetto di alluminio o legno. È possibile la posa di lastre di ceramica, listoni di ceramica, doghe in WPC o listoni in legno.

The ultimate solution for installing raised flooring on aluminum or wooden joists. It allows for the installation of ceramic slabs, ceramic planks, WPC deck boards, or wooden planks.

SUPPORTI

SUPPORTS



Gli specialisti delle sottostrutture per pavimenti sopraelevati esterni

The outdoor raised floor specialists

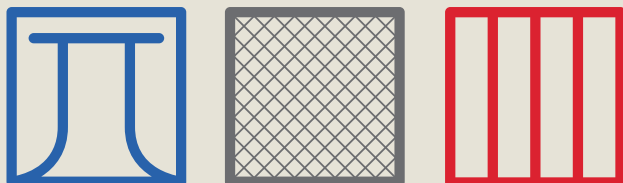

I supporti Eterno Ivica si adattano ad ogni tipo di sottofondo con semplicità e sicurezza per garantire sempre una pavimentazione sopraelevata omogenea ed elegante, senza apportare interventi radicali alla struttura preesistente ed eliminare alla radice i problemi di umidità, infiltrazione d'acqua, passaggio di cavi o tubi, permettendo sempre una facile e veloce ispezionabilità.

Dopo una prima regolazione, la posa della pavimentazione prescelta viene completata con precisione millimetrica tramite la chiave di regolazione, anche a pavimento finito. La testa bicomponente offre un esclusivo appoggio in morbida gomma antiscivolo ed anti-rumore. Le alette sono asportabili con estrema facilità mentre la nuova base a rottura facilitata garantisce una posa semplice e veloce senza l'utilizzo di strumenti da taglio.

Eterno Ivica supports easily and securely adapt to any type of substrate, ensuring a consistently even and elegant raised flooring. This is achieved without requiring radical interventions to the existing structure, effectively addressing issues like moisture, water infiltration, cable or pipe passage. This design also allows for easy and quick inspections..

After an initial adjustment, the chosen flooring installation is completed with millimetric precision using the adjustment key, even after the flooring is finished. The two-component head provides an exclusive soft rubber support, which is slip-resistant and reduces noise. The tabs can be easily removed, while the new easy-break base ensures a simple and quick installation without the use of cutting tools.

Supporti regolabili in altezza

Adjustable height supports

I supporti regolabili Eterno Ivica offrono molteplici soluzioni per compensare piccole imperfezioni e grandi pendenze di qualsiasi piano di posa, così da realizzare sempre pavimentazioni perfettamente stabili e piane.

I supporti vengono semplicemente appoggiati sopra la membrana impermeabilizzante o qualsiasi altra superficie destinata a essere pavimentata.

The Eterno Ivica adjustable height supports offer multiple solutions to compensate for small imperfections and large gradients of any laying surface so as to always achieve very stable and perfectly flat floors. The paving supports are simply set on the waterproofing membrane or any other surface to be paved.

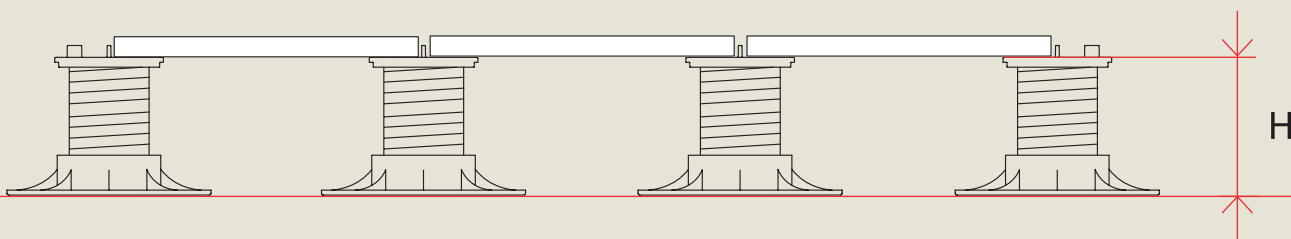

- Altezza minima (H): 10 mm (Star.T)
- *Minimum height (H): 10 mm (Star.T)*
- Altezza Massima (H): 1.000 mm (PR-SR/SRT-SE-NM)
- *Max. Height (H): 1.000 mm (PR-SR/SRT-SE-NM)*

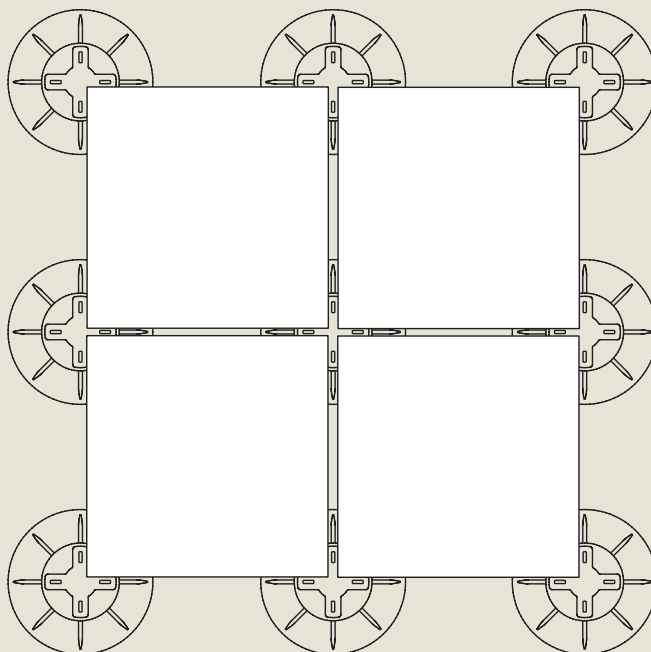

L'esclusiva chiave di regolazione, elemento essenziale del sistema, utilizzabile per i supporti Pedestal Prime®, Reversus®, Eterno SE e New Maxi NM, permette la regolazione dei supporti, conseguentemente del pavimento soprastante, anche a pavimento finito, evitando pertanto di doverlo sollevare.

The unique adjustment key, using with Pedestal Prime®, Reversus®, Eterno SE Support and New Maxi NM Support, is an essential element of the system which allows the control of the paver supports (and consequently the floor above) even when the flooring has already been laid, without the need to lift any slab.

Supporti ad altezza fissa (non regolabili)

Fixed height supports (not adjustable)

La linea di supporti con altezza fissa di Eterno Ivica rappresenta la soluzione più rapida ed economica per la posa di lastre.

Grazie alle sue diverse gamme, EH Rubber, EH, DM e CR i supporti ad altezza fissa sono un ottimo alleato per realizzare pavimenti sopraelevati da esterno facilmente e velocemente.

The fixed height supports line by Eterno Ivica represents the most rapidly and inexpensively solution for laying slabs.

Thanks to its three different ranges EH Rubber, EH, DM and CR, the fixed height supports are a great service to realize outdoor raised floor in an easy and fast way.

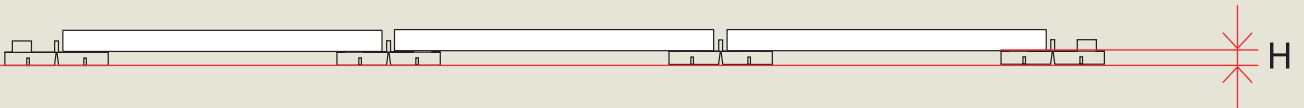

- Altezza minima (H): 6 mm (EH RUBBER 6 mm)
- Minimum height (H): 6 mm (EH RUBBER 6 mm)
- Altezza Massima (H): 20 mm (EH 20) - 25 mm (EH 20+ Equilibratore basculante)
- Maximum Height (H): 20 mm (EH 20) - 25 mm (EH 20 + Tilting balancer)

N.B. I supporti fissi della serie EH (12-15-20 mm) sono sovrapponibili tra loro. Si consiglia di sovrapporre al massimo 3 supporti. Si riportano alcuni esempi:

N.B. The fixed supports of the EH series (12-15-20 mm) can be overlapped on each other. It is recommended to overlap a maximum of 3 supports. Here are some examples:

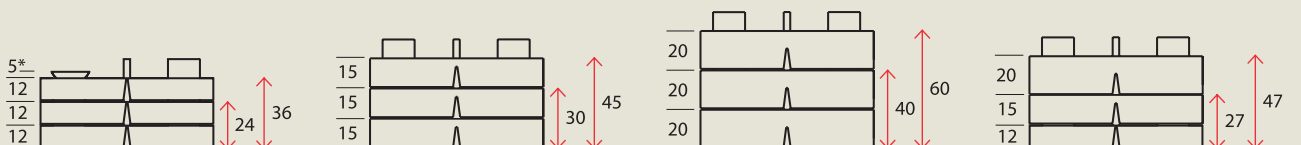
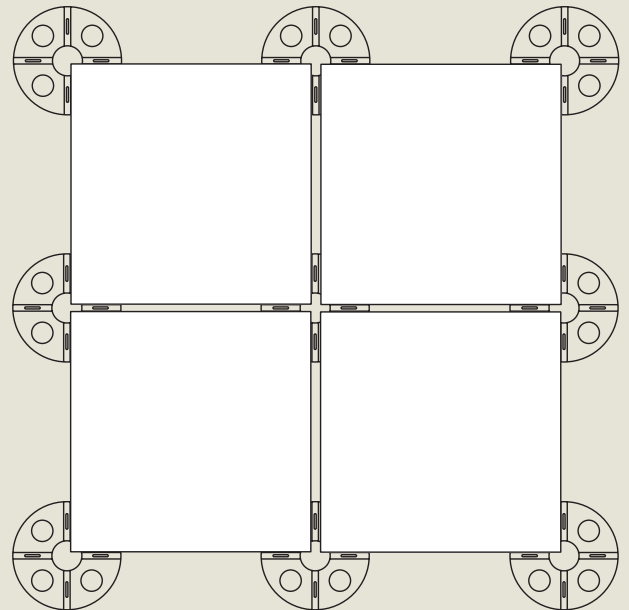

* Inserendo l'Equilibratore Basculante si aumenta l'altezza di 5 mm.

* By inserting the Balancer, the height is increases by 5 mm.

Base a rottura facilitata

Easy-break base

BREVETTATO

PATENTED

La base dei Supporti Reversus®, Eterno SE e New Maxi NM da oggi con rottura facilitata; Eterno Ivica ha studiato e brevettato la nuova base con rottura facilitata: un plus per la base dei supporti che renderà vita facile a tutti i posatori, in quanto non serviranno più gli utensili da taglio per adattare la base contro la parete o l'accoppiamento delle clip tamponamento verticale base.

In più le due nervature di appoggio facilitano la posa del profilo verticale perimetrale.

The base of the supports Reversus®, Eterno SE and New Maxi NM with easy break; Eterno Ivica has invented and patented the new Base with easy break system: a plus for the base of the supports that will make life easier for all installers. Installation becomes even easier and faster because cutting tools aren't needed anymore to fit the base against the wall or to couple the vertical lining clips. Two support ribs also facilitate the installation of the perimeter vertical profile.

Vantaggi

- rottura facile e veloce con una sola leggera pressione della mano
- posa semplice e veloce senza l'utilizzo di strumenti da taglio
- punto di rottura stondato per non danneggiare il manto impermeabile

Advantages

- quick and easy breaking with just one light pressure of the hand
- easy installation without the use of cutting tools
- rounded breaking point to avoid damaging the waterproof covering



La prima e unica base con rottura facilitata

The first and only base with easy break

Pre-incisione per rottura facilitata
Engraved for easy-break

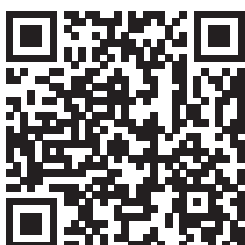
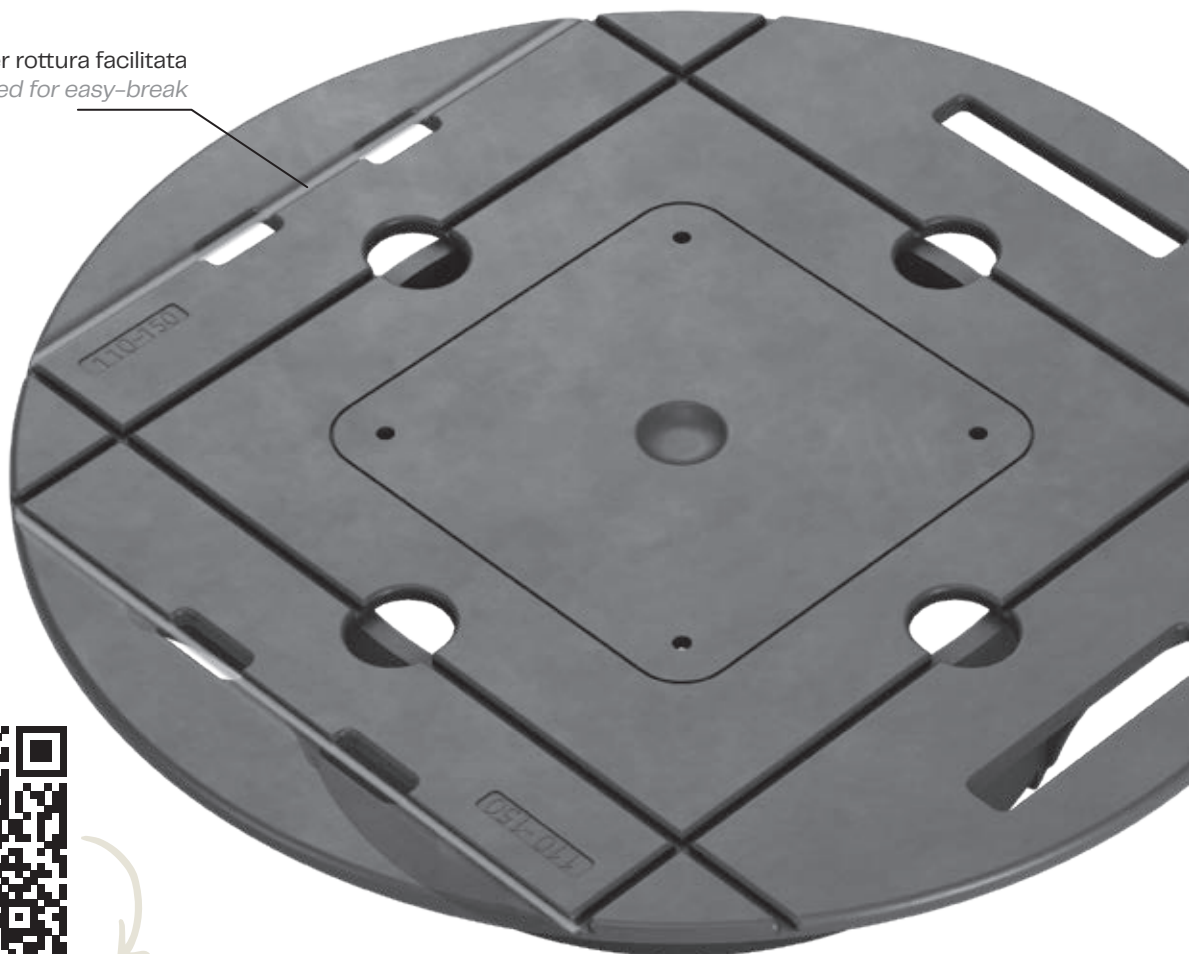

Guarda il video
Watch the video



Con una semplice pressione della mano lungo la pre-incisione, la base si spezza. Il punto di rottura è stonato così da non danneggiare un possibile manto impermeabile. Le due nervi facilitano la posa del nuovo profilo verticale. La posa delle clip tamponamento verticale base angolari risulta semplice e, soprattutto, veloce e sicura.

With a simple pressure of the hand along the engraved, the base is swept. The breaking point is rounded to avoid damaging a possible waterproof covering. The two ribs facilitate the installation of the new vertical profile. The installation of the vertical lining clips base is simple and, above all, fast and safe.



Testa bicomponente

PP + gomma

Two-component PP head + rubber



Testa bicomponente, disponibile basculante e fissa, \varnothing 110 mm con alette standard spessore 4 mm, H12 mm. Su richiesta spessore alette 2 o 3 mm.

Two-component head, available in both tilting and fixed versions, \varnothing 110 mm with standard tabs thickness of 4 mm, H12 mm. On request, tab thickness can be 2 or 3 mm.



Testa bicomponente, disponibile basculante e fissa, \varnothing 110 mm per travetto in alluminio. L'aggancio con le sue specifiche alette, permette di accogliere il travetto senza necessità di ulteriori fissaggi.

Two-component head, available in both tilting and fixed versions, \varnothing 110 mm for aluminum joists. The attachment with its specific tabs allows the joist to be accommodated without the need for additional fixings.



Testa XL bicomponente, disponibile basculante e fissa, con alette standard spessore 4 mm, H12 mm. Con il diametro di 150 mm offre una superficie d'appoggio superiore allo standard.

Su richiesta spessore alette 2 o 3 mm.

XL two-component head, available in both tilting and fixed versions, with standard tabs thickness of 4 mm, H12 mm. With a diameter of 150 mm, it provides a larger support surface compared to the standard size. On request, tab thickness can be 2 or 3 mm.



Testa bicomponente a incrocio per travetti in alluminio, disponibile basculante e fissa, \varnothing 130 mm. Può essere utilizzata in sostituzione della classica testa per travetto in alluminio per l'appoggio fino a 4 travetti contemporaneamente.

Criss-cross two-component head for aluminum joists, available in both tilting and fixed versions, \varnothing 130 mm. It can be used as a replacement for the classic head for aluminum joists, allowing support for up to 4 joists simultaneously.

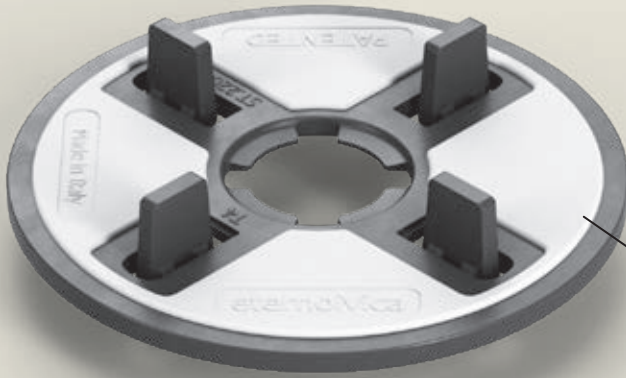

BREVETTATO
PATENTED

La parte in gomma permette di abbattere lo scivolamento delle lastre e ridurre sensibilmente il rumore
The rubber part helps to reduce the slipping of the slabs and significantly reduce noise

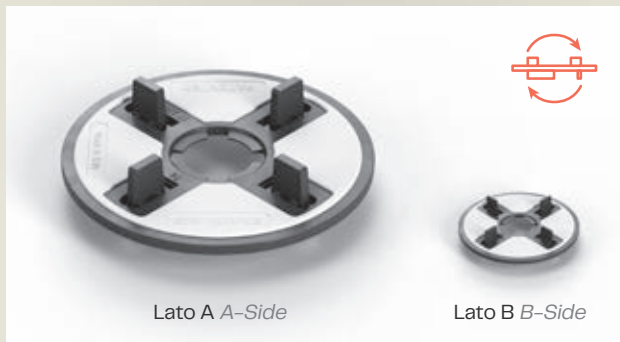

Testa bicomponente reversibile SR Ø 110 mm con alette H12 mm di spessore 4 mm da un lato e 2 mm dall'altro.
Reversible SR two-component head Ø 110 mm with H12 mm tabs of 4 mm thickness on one side and 2 mm on the other side.



Testa bicomponente reversibile SRT Ø 110 mm con alette di spessore 4 mm H12 mm da un lato e la predisposizione per l'aggancio con travetti di alluminio o legno dall'altro.
Reversible SRT two-component head Ø 110 mm with H12 mm tabs of 4 mm thickness on one side and the compatibility for attachment with aluminum or wooden joists on the other side.

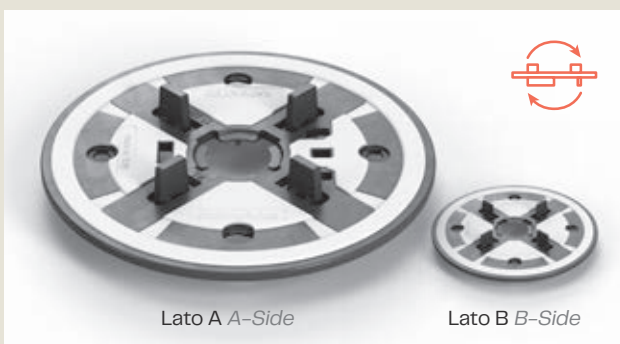

Testa XL bicomponente reversibile SR Ø 150 mm con alette H12 mm di spessore 4 mm da un lato e 2 mm dall'altro. Con il diametro di 150 mm offre una superficie d'appoggio superiore allo standard.
Reversible XL two-component head Ø 150 mm with H12 mm tabs of 4 mm thickness on one side and 2 mm on the other side. With a diameter of 150 mm, it provides a larger support surface compared to the standard size.

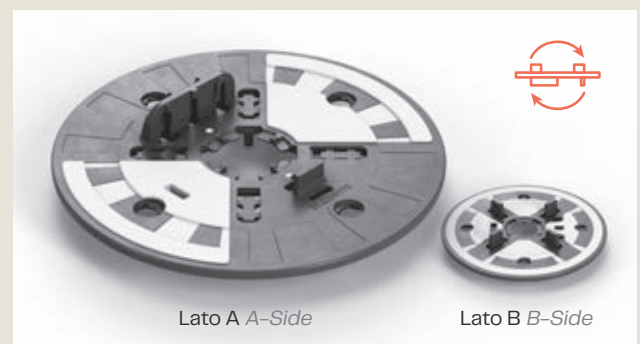

Testa XL bicomponente reversibile SRT Ø 150 mm con alette di spessore 4 mm H12 da un lato e la predisposizione per l'aggancio con travetti di alluminio o legno dall'altro. Con il diametro di 150 mm offre una superficie d'appoggio superiore allo standard.
Reversible XL two-component head Ø 150 mm with H12 mm tabs of 4 mm thickness on one side and the compatibility for attachment with aluminum or wooden joists on the other side. With a diameter of 150 mm, it provides a larger support surface compared to the standard size.

Testa bicomponente fissa o autolivellante

Fixed or self-leveling
two-component head

Testa autolivellante \varnothing 110 mm
che compensa automaticamente fino
al 5% di pendenza

*Self-leveling head \varnothing 110 mm that
automatically compensates up to
5% slope*

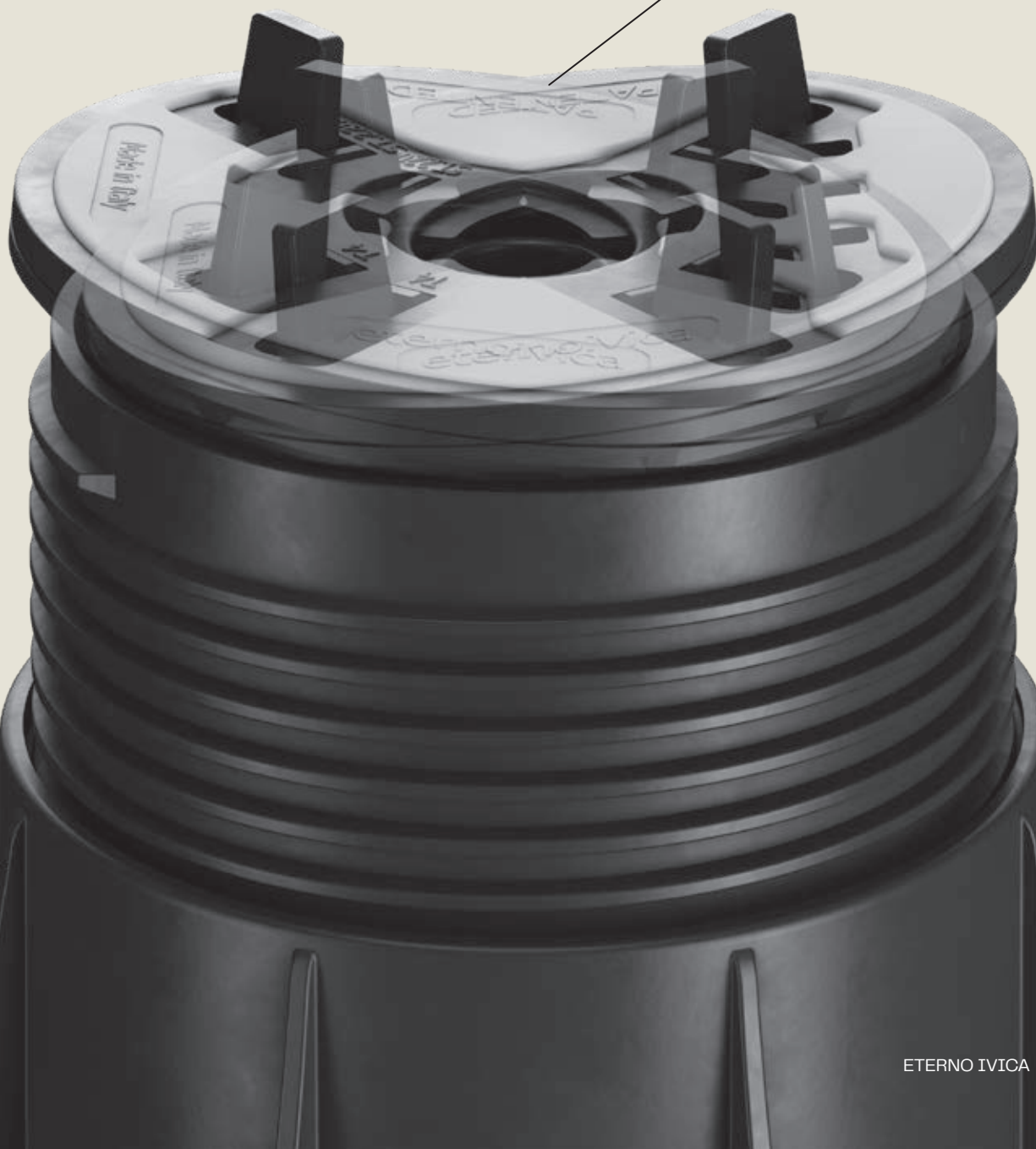

Testa autolivellante per supporti PR e SE

Self-leveling head for PR and SE supports



Aggancio testa-vite. L'aggancio sulla testa evita la fuoriuscita della testa dalla sede dei supporti PR e SE.

Coupling head-screw. The coupling on the head prevents the escape of the head from the seat of PR and SE supports.

Testa fissa per supporti NM

Fixed head for NM supports



Aggancio testa-vite. L'aggancio sulla testa evita la fuoriuscita della testa dalla sede del supporto NM.

Coupling head-screw. The coupling on the head avoids the leakage of the head from the seat of NM Support.

I supporti con testa fissa possono compensare fino al 2% di pendenza grazie all'accessorio Twist

The fixed-head supports can compensate for up to 2% of slope thanks to the Twist accessory



FOCUS

Blocco testa basculante per supporti PR e SE

Locking system for PR and SE supports

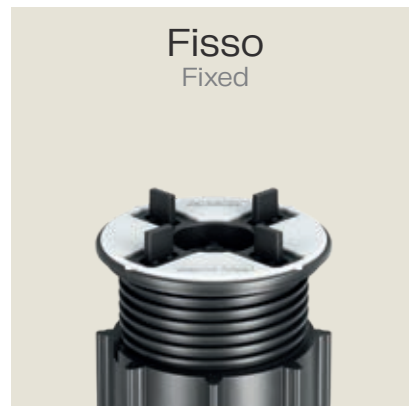
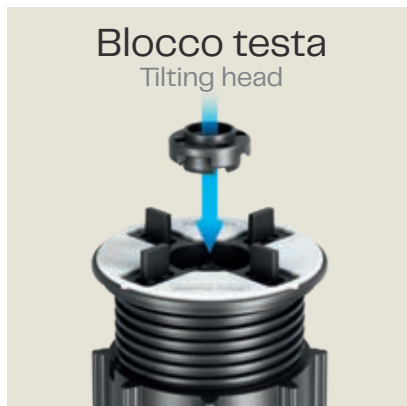

Il fermo per blocco testa basculante si adatta sia alla testa standard che alla nuova Testa XL.

Compatibile con il Supporto Regolabile Eterno SE e con il Supporto Pedestal Prime® PR.

Il fermo per blocco testa, inserito al centro del supporto, ne impedisce il movimento basculante rendendo la testa fissa.

The lock for tilting head is suitable for both the standard head and the new XL Head. It is compatible with the Adjustable Eterno SE Support and the Pedestal Prime® PR Support.

The lock, when inserted at the center of the support, prevents the tilting movement keeping the head fixed in place.

Accessorio per rendere la testa basculante per supporto SR/SRT

Accessory to make the head tilting for SR/SRT support





Il supporto Reversus® SR/SRT nasce fisso ma può trasformarsi in basculante con l'aggiunta dello speciale accessorio.

È un elemento aggiuntivo che si aggancia sotto alla testa formando un corpo unico che permette di compensare fino al 5% di pendenza aumentando di soli 5 mm l'altezza totale del supporto.

Reversus® SR/SRT support is initially fixed but can be transformed into a tilting head pedestal with the addition of a special accessory. This additional element attaches underneath the head, forming a single unit that allows for compensation of up to 5% slope while increasing the total height of the support by just 5 mm.

Teste bicomponenti PP+ Gomma

Two-component PP + Rubber heads



CODICE CODE	DESCRIZIONE DESCRIPTION	MISURA SIZE	PAG. LISTINO PRICE LIST PAGE	PZ 	PZ 
E035101204	Testa PR-SE bicomponente autolivellante, aletta 4 mm H 12 mm <i>PR-SE two-component self-leveling head, 4 mm tab H 12 mm</i>	Ø 110 mm	7	200	6400
E035201204	Testa PR-SE XL bicomponente autolivellante, aletta 4 mm H 12 mm <i>PR-SE two-component self-leveling XL head, 4 mm tab H 12 mm</i>	Ø 150 mm	7	100	3200
E035011204	Testa fissa NM bicomponente, aletta 4 mm H 12 mm <i>NM two-component fixed head, 4 mm tab H 12 mm</i>	Ø 110 mm	19	200	6400
E035061204	Testa fissa NM XL bicomponente aletta 4 mm H 12 mm <i>NM XL two-component fixed head tabs 4 mm H 12 mm</i>	Ø 150 mm	19	100	3200
E035100010	Testa PR-SE bicomponente autolivellante per travetto in alluminio <i>PR-SE two-component self-leveling head for aluminium joist</i>	Ø 110 mm	7	200	6400
E034000010	Testa NM bicomponente fissa per travetto in alluminio <i>NM two-component fixed head for aluminium joist</i>	Ø 110 mm	19	200	6400
E035203001	Testa PR-SE bicomponente autolivellante (a incrocio) per travetto in alluminio <i>Criss-cross PR-SE two-component self-leveling head or aluminium joist</i>	Ø 130 mm	7	150	4800
E035093001	Testa NM bicomponente fissa a incrocio per travetto in alluminio <i>Criss-cross NM two-component fixed head for aluminium joist</i>	Ø 130 mm	19	150	4800
E030001010	Testa reversibile SRT bicomponente alette 4 mm / Travetto in alluminio e legno <i>SRT two-component reversible head with 4 mm tabs / aluminium and wooden joist</i>	Ø 110 mm	10	200	6400
E030001020	Testa SR bicomponente reversibile alette 4/2 mm <i>SRT two-component reversible head tabs 4/2 mm</i>	Ø 110 mm	10	200	6400
E030001030	Testa SRT XL reversibile bicomponente alette 4 mm / Travetto in alluminio e legno <i>SRT two-component reversible XL head with 4 mm tabs / aluminium and wooden joist</i>	Ø 150 mm	10	100	3200
E030001040	Testa SR XL bicomponente reversibile alette 4/2 mm <i>SR two-component reversible XL head tabs 4/2 mm</i>	Ø 150 mm	10	100	3200
E030001000	Accessorio per rendere basculante la testa SR/SRT al 5% <i>Accessory to make the SR/SRT head tilt at 5%</i>	-	10	200	6400
E036000100	Blocco testa basculante per supporti PR e SE <i>Locking system for Prime and Eterno SE self leveling pedestal</i>	-	7	800*	-

* In sacchetti da 100 pz.

* Bags of 100 pcs.

Teste monocomponenti PP

Single-component PP heads

CODICE CODE	DESCRIZIONE DESCRIPTION	MISURA SIZE	PAG. LISTINO PRICE LIST PAGE	PZ 	PZ 
E035102530	Testa PR-SE autolivellante per travetto in legno <i>PR-SE self-leveling head for decking</i>	Ø 110 mm	7	100	4200
E034000030	Testa NM fissa per travetto in legno <i>NM fixed head for decking</i>	Ø 110 mm	19	150	6300

Guida alla scelta dei supporti

Guide to the choice of supports



Pedestal Prime® PR

3 soli articoli per coprire altezze fino a 420 mm. Testa basculante e vite telescopica eliminano gli errori in cantiere, il prodotto premium di Eterno Ivica.

Only 3 items to cover heights up to 420 mm. The tilting head and telescopic screw eliminate errors on-site, the premium product by Eterno Ivica.



Reversus® SR/SRT

Il primo supporto al mondo con testa reversibile. Un'esclusiva di Eterno Ivica, perfetto per chi lavora sia con le lastre ceramiche che con il decking. Nasce fisso, diventa basculante.

The world's first support with a reversible head. An exclusive feature by Eterno Ivica, perfect for those working with both ceramic slabs and decking. It starts as fixed and transforms into a tilting head pedestal.



Eterno SE

Un grande classico. Testa basculante al 5%, 20 anni di storia, amato dai professionisti di tutto il mondo.

A true classic. Tilting head at 5%, with 20 years of history and beloved by professionals worldwide.



New Maxi NM

Il supporto a testa fissa più venduto nel mondo. Pratico ed economico, il prodotto più semplice di Eterno Ivica con la testa in bicomponente.

The best-selling fixed-head support in the world. Practical and cost-effective, it is the simplest product from Eterno Ivica with a two-component head.



Basic SB

Economico ed essenziale, per la posa di tutti i giorni che non necessita di accortezze particolari.

Affordable and essential, suitable for everyday installations that do not require special precautions.



Star.T

Il supporto regolabile in altezza più sottile al mondo, perfetto per compensare altezze di pochissimi cm.

The world's thinnest height-adjustable support, perfect for compensating heights of just a few centimeters.

Caratteristiche

Features

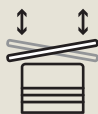
**PR - SE**

Testa autolivellante che compensa automaticamente pendenze fino al 5%
Self-leveling head that automatically compensates up to 5% slopes

**SE - SR/SRT - NM**

Base con rottura facilitata per una posa più rapida
Base with easy break for faster installation

**PR - SE - SR/SRT - NM**

Testa con parte superiore in gomma antirumore e antiscivolo
Head with upper part in noise-reducing anti-slip rubber

330 cm²**SE - SR/SRT
NM - SB**

Base di appoggio liscia di 330 cm²
Smooth support base of 330 cm²



10 mm

Regolazione millimetrica a partire da 10 mm
Millimeter adjustment starting from 10 mm

**PR - SE
SR/SRT - NM - Star.T**

Regolazione dell'altezza, anche a pavimento finito, grazie all'esclusiva chiave di regolazione
Possibility of adjusting the height once the floor has been finished, thanks to the exclusive adjustment key

+80°C
-40°C

Resistente a temperature fra -40°C e +80°C
Resistant to temperatures ranging from -40°C to +80°C



Totalmente riciclabile
Fully recyclable



Resistente agli agenti atmosferici, agli acidi, all'invecchiamento, ai raggi UV
Resistant to weathering, acids, UV rays and wear and tear

**PR - SE
SR/SRT - NM - Star.T**

Alette facilmente asportabili
Easily removable tabs



Test di carico a rottura certificati
Test of tensile strength certified



Utilizzabile con qualsiasi pavimentazione da esterno autoportante
Can be used in conjunction with any outdoor flooring



Base con deflusso acqua sicuro e garantito
Base with safe and guaranteed water flow

**PR - SE
SR/SRT - NM - SB**

Blocchi di sicurezza antisvitamento
Anti-unscrewing safety blocks





2 - 10 mm

PR - SE - NM

Alette con spessore da 2 a 10 mm
Tabs with thickness from 2 to 10 mm



Guida alla scelta dei supporti

Guide to the choice of supports

TIPOLOGIA DI POSA LAYING SYSTEM	SUPPORTI REGOLABILI IN ALTEZZA HEIGHT-ADJUSTABLE SUPPORTS							SUPPORTI NON REGOLABILI IN ALTEZZA FIXED HEIGHT SUPPORTS
	PR* Testa alette <i>Tab head</i> 4 mm H 12 mm	SE Testa alette <i>Tab head</i> 4 mm H 12 mm	SR Testa alette <i>Tab head</i> 2-4 mm H 12 mm	SRT** Testa alette <i>Tab head</i> 4 mm H 12 mm - Travetto <i>Joist</i>	NM Testa alette <i>Tab head</i> 4 mm H 12 mm	SB Testa alette <i>Tab head</i> 4 mm H 12 mm	Star.T Testa alette <i>Tab head</i> 4 mm H 12 mm	EH / EHR Testa alette <i>Tab head</i> 4 mm H 12 mm
 Posa diretta su supporto <i>Direct installation on a support</i>	✓	✓	✓	✓	✓	✓	✓	✓
 Posa su griglia <i>Installation on a grid</i>	✓	✓	✓	✓	✓	✓	✓	✓
 Posa con travetto <i>Installation with a joist</i>	✗	✗	✗	✓	✗	✗	✗	✗

* PR (Pedestal Prime®) è l'unico supporto che con solo tre misure (codici) raggiunge l'altezza di 420 mm. Prodotto speciale per Posatori e Rivenditori.

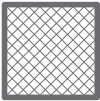
** SRT (Reversus®) è l'unico supporto al mondo che consente, con un unico prodotto, di posare le lastre direttamente sui SUPPORTI (Pedestal), posare con il sistema GRIGLIA (GRF) e con il sistema TRAVETTO (Woodeck), sia in modalità "basculante autolivellante" che in modalità "fissa". Prodotto speciale per Rivenditori.

	TIPOLOGIA DI POSA LAYING SYSTEM	SUPPORTI REGOLABILI IN ALTEZZA HEIGHT-ADJUSTABLE SUPPORTS					
		PR* Testa tra- vetto alluminio/ legno <i>Joist head (aluminum/ wood)</i>	SE Testa tra- vetto alluminio/ legno <i>Joist head (aluminum/ wood)</i>	SRT** Testa alette 4 mm H 12 mm - Travetto alluminio/ legno <i>Tab head 4 mm H 12 mm / Joist head (aluminum/ wood)</i>	NM Testa tra- vetto alluminio/ legno <i>Joist head (aluminum/ wood)</i>	SB Testa tra- vetto alluminio/ legno <i>Joist head (aluminum/ wood)</i>	Star.T Testa tra- vetto alluminio/ legno <i>Joist head (aluminum/ wood)</i>
	Posa diretta su supporto <i>Direct installation on a support</i>	⊗	⊗	⊙	⊗	⊗	⊗
	Posa su griglia <i>Installation on a grid</i>	⊗	⊗	⊙	⊗	⊗	⊗
	Posa con travetto <i>Installation with a joist</i>	⊙	⊙	⊙	⊙	⊙	⊙

* PR (Pedestal Prime®) is the only support that, with just three sizes (codes), reaches a height of 420 mm. It is a special product for installers and retailers.

** SRT (Reversus®) is the only support in the world that allows for direct installation of slabs on pedestals, installation with the grid system (GRF), and installation with the joist system (Woodeck), both in "self-leveling tilting" mode and in "fixed" mode, all with a single product. It is a special product for retailers.

CARATTERISTICHE FEATURES	SUPPORTI REGOLABILI IN ALTEZZA HEIGHT-ADJUSTABLE SUPPORTS			
	PR*	SE	SR	SRT**
Altezza minima <i>Minimum height</i>	30 mm	28 mm	26/31 mm	26/31 mm
Altezza massima senza prolunghe <i>Maximum height without extensions</i>	420 mm	215 mm	280/285 mm	280/285 mm
Compensazione pendenza <i>Slope compensation</i>	5%	5%	5% con accessorio <i>5% with accessory</i>	
Minima gestione dei codici <i>Minimal code management</i>	✓	✗	✗	✓
Unico codice compatibile con qualsiasi tipologia di posa <i>Single code compatible with any type of installation</i>	Con 3 tipologie di teste <i>With 3 types of heads</i>	Con 3 tipologie di teste <i>With 3 types of heads</i>	✗	Solo 1 testa <i>Only 1 head</i>
Testa autolivellante (velocità di posa) <i>Self-leveling head (laying speed)</i>	✓	✓	✓	✓
Convertitore autolivellante/fisso e viceversa <i>Self-leveling/fixed converter and vice versa</i>	✓	✓	✓	✓
Testa con gomma integrata in bimatereale <i>Head with integrated rubber in two-component</i>	✓	✓	✓	✓
Diametro testa <i>Head diameter</i>	110 e 150 mm	110 e 150 mm	110 e 150 mm	110 e 150 mm
Spessore alette <i>Tab thickness</i>	da 2 a 10 mm <i>from 2 to 10 mm</i>	da 2 a 10 mm <i>from 2 to 10 mm</i>	da 2 a 10 mm <i>from 2 to 10 mm</i>	da 2 a 10 mm <i>from 2 to 10 mm</i>
Alette facilmente asportabili <i>Easily removable tabs</i>	✓	✓	✓	✓
Base con rottura facilitata <i>Easy-break base</i>	✓	✓	✓	✓
Base di appoggio piena da 300 cm ² minimo <i>Minimum full support base of 300 cm²</i>	✓	✓	✓	✓
Regolazione millimetrica dell'altezza con la chiave <i>Millimetric height adjustment with the key</i>	✓	✓	✓	✓
Blocco di sicurezza antisvitamento <i>Anti-loosening safety lock</i>	✓	✓	✓	✓
Ampia gamma di accessori dedicati <i>Wide range of dedicated accessories</i>	✓	✓	✓	✓
Riduzione dello spazio a magazzino <i>Warehouse space reduction</i>	✓	✗	✗	✓
Prodotto confezionato già assemblato <i>Pre-assembled packaged product</i>	✓	✓	✓	✓
Riciclabile 100% <i>100% recyclable</i>	✓	✓	✓	✓
Test di carico certificati da ente esterno <i>Load tests certified by an external entity</i>	✓	✓	✓	✓

* PR (Pedestal Prime®) è l'unico supporto che con solo tre misure (codici) raggiunge l'altezza di 420 mm. Prodotto speciale per Posatori e Rivenditori.

** SRT (Reversus®) è l'unico supporto al mondo che consente, con un unico prodotto, di posare le lastre direttamente sui SUPPORTI (Pedestal), posare con il sistema GRIGLIA (GRF) e con il sistema TRAVETTO (Woodeck), sia in modalità "basculante autolivellante" che in modalità "fissa". Prodotto speciale per Rivenditori.

				SUPPORTI NON REGOLABILI IN ALTEZZA FIXED HEIGHT SUPPORTS
	NM	SB	Star.T	EH / EHR
	25 mm	27 mm	8 mm	6 mm
	270 mm	120 mm	15 mm	20 mm
	2% con Twist <i>2% with Twist</i>	2% con Twist <i>2% with Twist</i>	2% con Twist <i>2% with Twist</i>	2% con Twist <i>2% with Twist</i>
	⊗	⊗	N.C.	N.C. (non confrontabile) <i>(non-comparable)</i>
	Con 3 tipologie di teste <i>With 3 types of heads</i>	Con 3 tipologie di teste <i>With 3 types of heads</i>	Con 3 tipologie di teste <i>With 3 types of heads</i>	⊗
	⊗	⊗	⊗	⊗
	⊗	⊗	⊗	⊗
	✓	⊗	⊗	⊗
	110 e 150 mm	110 mm	152 mm	120-152 mm
	da 2 a 10 mm <i>from 2 to 10 mm</i>	2, 3, 4 mm	2, 3, 4 mm	2, 3, 4 mm
	✓	⊗	✓	N.C. (non confrontabile) <i>(non-comparable)</i>
	✓	✓	N.C.	N.C. (non confrontabile) <i>(non-comparable)</i>
	✓	✓	N.C.	N.C. (non confrontabile) <i>(non-comparable)</i>
	✓	⊗	✓	⊗
	✓	✓	N.C.	N.C. (non confrontabile) <i>(non-comparable)</i>
	✓	✓	✓	✓
	⊗	⊗	⊗	⊗
	✓	⊗	✓	✓
	✓	✓	✓	✓
	✓	✓	✓	✓

* PR (Pedestal Prime®) is the only support that, with just three sizes (codes), reaches a height of 420 mm. It is a special product for installers and retailers.

** SRT (Reversus®) is the only support in the world that allows for direct installation of slabs on pedestals, installation with the grid system (GRF), and installation with the joist system (Woodeck), both in "self-leveling tilting" mode and in "fixed" mode, all with a single product. It is a special product for retailers.



SUPPORTI REGOLABILI

ADJUSTABLE
SUPPORTS

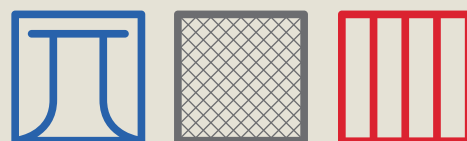

I supporti regolabili Eterno Ivica offrono molteplici soluzioni per compensare piccole imperfezioni e grandi pendenze di qualsiasi piano di posa, così da realizzare sempre pavimentazioni perfettamente stabili e piane. L'esclusiva chiave di regolazione, elemento essenziale del sistema, utilizzabile per i supporti Pedestal Prime®, Reversus®, Eterno SE e New Maxi NM, permette la regolazione dei supporti, conseguentemente del pavimento soprastante, anche a pavimento finito, evitando pertanto di doverlo sollevare.

I supporti vengono semplicemente appoggiati sopra la membrana impermeabilizzante o qualsiasi altra superficie destinata a essere pavimentata.

The Eterno Ivica adjustable supports offer multiple solutions to compensate for small imperfections and large gradients of any laying surface so as to always achieve very stable and perfectly flat floors. The unique adjustment key, using with Pedestal Prime®, Reversus®, Eterno SE Support and New Maxi NM Support, is an essential element of the system which allows the control of the paver supports (and consequently the floor above) even when the flooring has already been laid, without the need to lift any slab. The paving supports are simply set on the waterproofing membrane or any other surface to be paved.

PR

Supporto Pedestal Prime®

Pedestal Prime® support

开开开

Da 30 mm a 420 mm
di altezza con solo tre
prodotti
*From 30 mm to 420 mm
in height with only three
products*



Un unico prodotto con
tutti gli elementi integrati
*A single product with all
integrated elements*



Riduzione dello spazio
in magazzino
*Reduction of warehouse
space*



300 cm²

Base di appoggio liscia
di 300 cm²
*Smooth support base
of 300 cm²*



PR

Supporto regolabile autolivellante Pedestal Prime®

Pedestal Prime® adjustable and self-levelling support



Non servono anelli, tubi o prolunghie aggiuntive, la prolunga è integrata ed ergonomica

No additional rings, tubes or extensions are needed, the extension is integrated and ergonomic



Spese di trasporto considerevolmente ridotte dato che il prodotto viene fornito assemblato

Transport costs considerably reduced as the product is supplied assembled

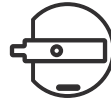

Base con "asole" per aggancio "clip" veloce brevettata

Base with "slots" for fast "clip" attachment patented

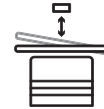

Un unico prodotto autolivellante o fisso, grazie all'inserimento del "blocco testa"

A single self-levelling or fixed product, thanks to the insertion of the "head block"



Guarda il video di presentazione

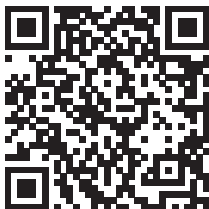

Watch the presentation video

Semplice: perchè già assemblato e pronto per la posa.

Forte: perchè resistente a carichi eccezionali, oltre ogni normativa.

Bello: perchè anche il design è stato curato nei minimi dettagli.

Mentre il mondo copia le nostre idee e i nostri modelli ci siamo spinti oltre, abbiamo osato, con l'entusiasmo e la passione che ci contraddistinguono. Abbiamo creato un prodotto sorprendente, abbiamo reinventato il supporto per le pavimentazioni esterne.

Siamo orgogliosi, abbiamo realizzato un capolavoro di ingegneria, unico, complesso da progettare ma semplice da utilizzare, con più elementi che si integrano tra di loro in un unico assieme perfetto.

Un prodotto straordinario, frutto di un'esperienza di 68 anni e di un grande lavoro di squadra, solo con tanta passione e professionalità potevamo progettare un prodotto simile, semplice, forte e bello.

Simple: because it is already assembled and ready for installation.

Strong: because it is resistant to exceptional loads, beyond all regulations.

Beautiful: because even the design has been studied in detail.

While the market tries to catch up with our products and solutions, we have moved forward with the enthusiasm and passion that distinguish us. We have created a remarkable product, reinventing the support for external flooring.

We are proud to have developed a unique engineering masterpiece, complex to design but simple to use, with multiple elements that integrate with each other in a single, perfect assembly.

An extraordinary product, the result of 68 years of experience and great teamwork, only with such passion and professionalism we could design a similar, simple, strong and beautiful product.



Supporto con portata certificata
Tested for loading bearing capacity

PR**Vantaggi
Advantages**

- Da 30 mm a 420 mm di altezza con solo tre prodotti
- Un unico prodotto con tutti gli elementi integrati
- Riduzione dello spazio in magazzino
- Base piena da 300 cm² con sagoma speciale brevettata
- Base con "asole" per aggancio "clip" veloce brevettata
- Un solo taglio della base per fare l'angolo
- Un unico prodotto autolivellante o fisso, grazie all'inserimento del "blocco testa"
- Non servono anelli, tubi o prolunghe aggiuntive, la prolunga è integrata ed ergonomica
- Compatibile con tutti gli accessori della gamma Pedestal/Grid Raised Floor/Woodeck
- Spese di trasporto considerevolmente ridotte dato che il prodotto viene fornito assemblato

- *From 30 mm to 420 mm in height with only three products*
- *A single product with all the integrated elements*
- *Reduction of warehouse space*
- *300 cm² solid base with patented special shape*
- *Base with "slots" for fast "clip" attachment patented*
- *A single cut of the base to make the corner*
- *A single self-leveling or fixed product, thanks to the insertion of the "head block"*
- *No additional rings, tubes or extensions are needed, the extension is integrated and ergonomic*
- *Compatible with all accessories of the Pedestal/Grid Raised Floor/Woodeck range*
- *Transport costs considerably reduced as the product is supplied assembled*

PR

Descrizione componenti Components description



FOCUS

Prolunga integrata: tutte le
altezze in soli 3 supporti
*Integrated extension:
all heights in just 3 supports*



PR

Teste compatibili

Compatible heads

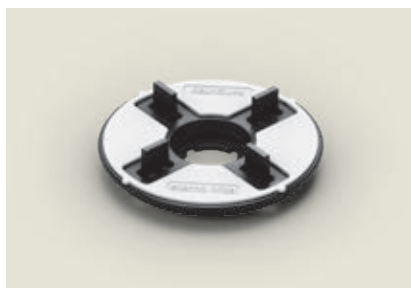

Testa basculante Ø 110 mm aletta 4 mm H 12 mm

Testa per la posa delle lastre direttamente su supporto o con griglia. Su richiesta spessore alette 2 o 3 mm.

Self-leveling head Ø 110 mm tab 4 mm H 12 mm

The head is designed for laying slabs directly on the support or with a grid system. On request, the tabs can be customized with a thickness of 2 or 3 mm.



Testa basculante Ø 110 mm per travetto in alluminio

L'aggancio con le sue specifiche alette, permette di accogliere il travetto senza necessità di ulteriori fissaggi.

Self-leveling head Ø 110 mm for aluminium joist

The attachment with its specific tabs allows the joist to be accommodated without the need for additional fixings.

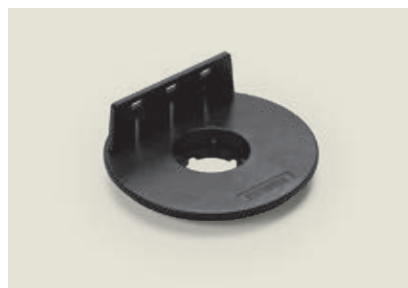

Testa basculante Ø 110 mm per travetto in legno

L'aletta laterale permette di accogliere con la massima semplicità di fissaggio e rapidità di installazione tutte le tipologie di sottostrutture.

Self-leveling head Ø 110 mm for decking

The lateral flap allows for the easiest and fastest installation of all types of substructures, ensuring maximum simplicity in the attachment process.

CODICE CODE	DESCRIZIONE DESCRIPTION	MISURA SIZE	PAG. LISTINO PRICE LIST PAGE	PZ 	PZ 
E035101204	Testa bicomponente autolivellante, aletta 4 mm H 12 mm <i>Two-component self-leveling head, 4 mm tab H 12 mm</i>	Ø 110 mm	7	200	6400
E035100010	Testa bicomponente autolivellante per travetto alluminio <i>Two-component self-leveling head for aluminium joist</i>	Ø 110 mm	7	200	6400
E035102530	Testa autolivellante per travetto in legno <i>Self-leveling head for decking</i>	Ø 110 mm	7	100	4200

PR

Teste compatibili

Compatible heads



Testa basculante XL Ø 150 mm aletta 4 mm H 12 mm

Con il diametro di 150 mm offre una superficie d'appoggio superiore allo standard.
Su richiesta spessore alette 2 o 3 mm.

Self-leveling XL head Ø 150 mm tab 4 mm H 12 mm

With a diameter of 150 mm, it provides a larger support surface compared to the standard size. On request, tab thickness can be 2 or 3 mm.



Testa basculante Ø 130 mm ad incrocio per travetti in alluminio

Può essere utilizzata in sostituzione della classica testa per travetto in alluminio per l'appoggio fino a 4 travetti contemporaneamente.

Self-leveling Criss-cross head Ø 130 mm for aluminium joist

It can be used as a replacement for the classic head for aluminum joists, allowing support for up to 4 joists simultaneously.



Teste speciali per utilizzi particolari

Sono disponibili teste speciali per l'aggancio anti-vento delle lastre o autoestinguenti.

Special heads for specific uses/applications

Special heads are available for the windproof attachment of the slabs or self-extinguishing purposes.

CODICE CODE	DESCRIZIONE DESCRIPTION	MISURA SIZE	PAG. LISTINO PRICE LIST PAGE	PZ 	PZ 
E035201204	Testa XL bicomponente autolivellante, aletta 4 mm H 12 mm <i>Two-component self-leveling XL head, 4 mm tab H 12 mm</i>	Ø 150 mm	7	100	3200
E035203001	Testa bicomponente autolivellante a incrocio per travetto alluminio <i>Two-component self-leveling Criss-cross head for aluminium joist</i>	Ø 130 mm	7	150	4800
E036000100	Blocco testa basculante <i>Locking system</i>	-	7	800*	-

* In sacchetti da 100 pz.

* Bags of 100 pcs.

L'innovazione parte dalla base

Innovation starts from the base

BREVETTATO
PATENTED

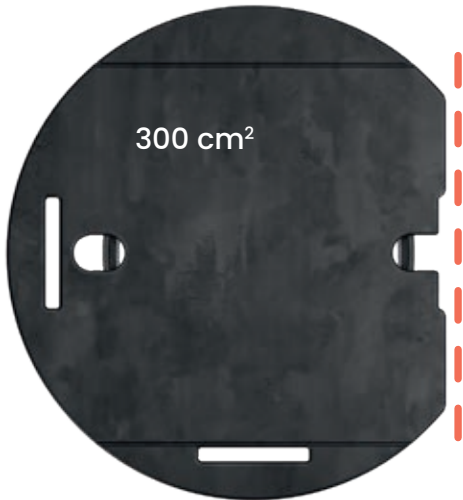

La speciale sagoma brevettata consente un notevole risparmio in fase di posa.
The special patented shape allows to save a considerable amount of time during installation.



Per facilitare e velocizzare ulteriormente la fase di posa sono state predisposte due "asole" per l'aggancio delle clip, assicurando così una presa ottimale al supporto.

To further facilitate and speed up the installation phase, two "slits" have been prepared for attaching the clips, thus ensuring optimal grip to the support.

Prolunga integrata

Integrated extension

Con i supporti Pedestal Prime® non servono anelli, tubi o prolunghe aggiuntive: la prolunga è già integrata.

Tre diverse misure per adattarsi perfettamente alle tre basi e consentire di coprire tutte le altezze da 30 mm a 420 mm. La sua forma ergonomica inoltre ne facilita la regolazione.

With the Pedestal Prime® supports you do not need additional rings, tubes or extensions: the extension is already integrated.

Three different sizes to adapt perfectly to the three bases and allow you to cover all heights from 30 mm to 420 mm. Its ergonomic shape also makes it easy to adjust.



30 - 65 mm



65 - 155 mm



155 - 420 mm

Prolunga per grandi altezze

Extension for great heights



Nel caso di altezze superiori a 420 mm Eterno Ivica ha progettato la Prolunga per grandi altezze, un elemento che si inserisce facilmente tra la “prolunga integrata” e la vite, adattabile al supporto PR3. Una, due o tre prolunghe, per raggiungere le altezze di 595 mm, 770 mm e 945 mm.

Anche questo elemento è dotato del blocco di sicurezza, sia nella parte inferiore che in quella superiore, sempre con la garanzia Pedestal by Eterno Ivica.

In the case of heights greater than 420 mm, Eterno Ivica has designed the PR Extension element, which fits easily between the already integrated extension and the screw. Compatible with the PR3 model only, with one, two or three extensions you can reach heights of 595 mm, 770 mm and 945 mm respectively.

This element is also equipped with a safety lock, both in the lower and in the upper part, according to our safety guarantee by Eterno Ivica.



310 mm

595 mm

410 mm

770 mm

515 mm

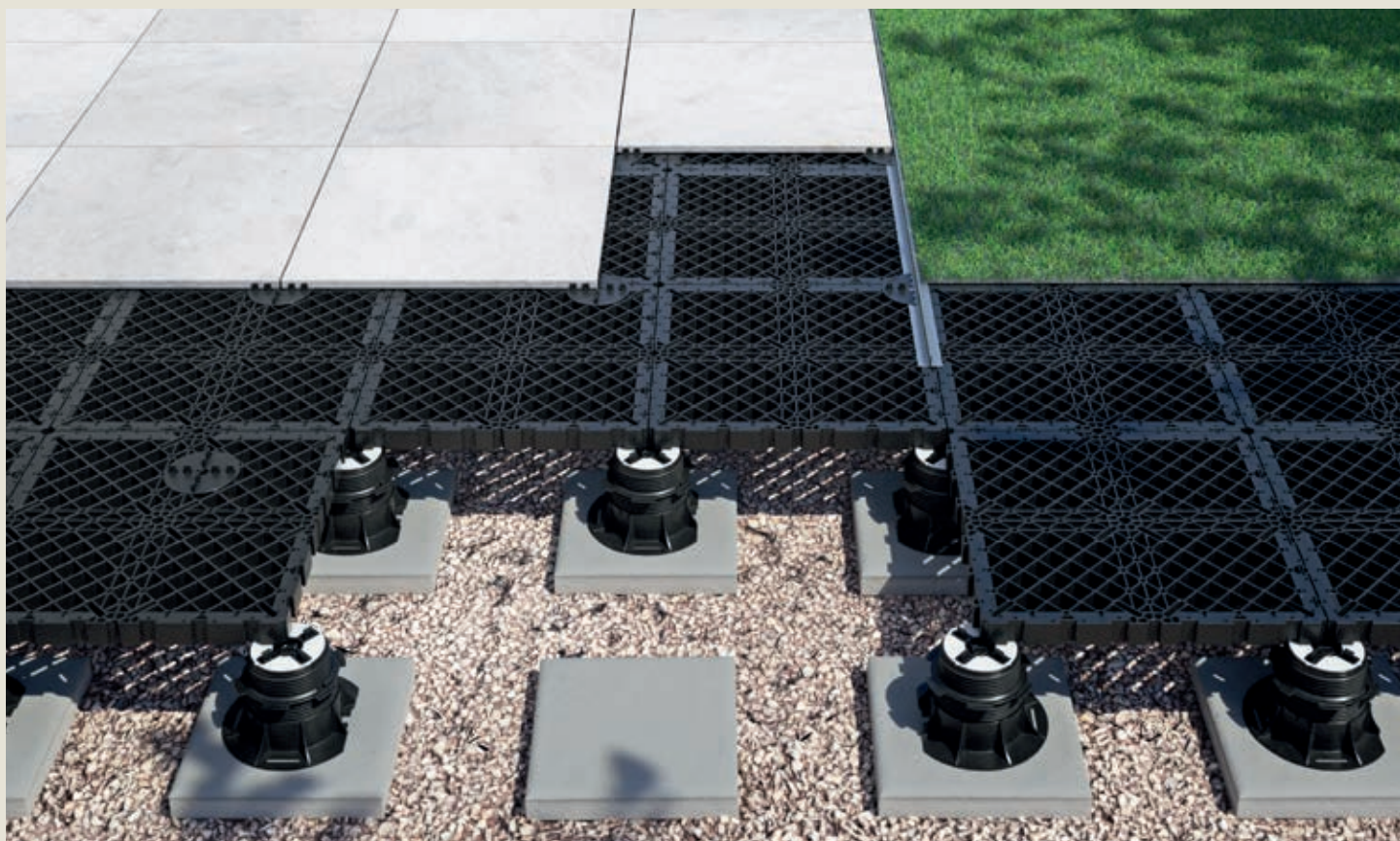

945 mm

DESCRIZIONE DESCRIPTION	MISURA SIZE	UNIT 
PR 3 + 1 prolunga PR <i>PR 3 + 1 PR extension</i>	310 - 595 mm	12 PR 3 + 12 PR
PR 3 + 2 prolunghe PR <i>PR 3 + 2 PR extensions</i>	410 - 770 mm	12 PR 3 + 2 X 12 PR
PR 3 + 3 prolunghe PR <i>PR 3 + 3 PR extensions</i>	515 - 945 mm	12 PR 3 + 3 X 12 PR



Supporto Pedestal Prime® per posa lastre
direttamente sui supporti o su griglia
Pedestal Prime® support for laying slabs directly
on supports or on a grid



CODICE CODE	DESCRIZIONE DESCRIPTION	MISURA SIZE	PAG. LISTINO PRICE LIST PAGE	PZ 	PZ 	
					Italia	Abroad
E500030065	PR 1 con testa autolivellante Ø 110 mm, alette 4 mm, H 12 mm <i>PR 1 with self-leveling head Ø 110 mm, tab 4 mm H 12 mm</i>	30-65 mm	4	25	1200	1350
E500060155	PR 2 con testa autolivellante Ø 110 mm, alette 4 mm, H 12 mm <i>PR 2 with self-leveling head Ø 110 mm, tab 4 mm H 12 mm</i>	65-155 mm	4	25	600	750
E500150420	PR 3 con testa autolivellante Ø 110 mm, alette 4 mm, H 12 mm <i>PR 3 with self-leveling head Ø 110 mm, tab 4 mm H 12 mm</i>	155-420 mm	4	12	288	336
E501000190	Prolunga PR* <i>PR Extension*</i>	-	4	12	504	576
E036000100	Blocco testa basculante <i>Locking system for self leveling Pedestal</i>	-	4	800**	-	-

* Utilizzabile con PR3.

** In sacchetti da 100 pz.

* Usable with PR3.

** Bags of 100 pcs.

Vantaggi Advantages





- Da 30 mm a 420 mm di altezza con solo tre prodotti
- Un unico prodotto con tutti gli elementi integrati
- Riduzione dello spazio in magazzino
- Base piena da 300 cm² con sagoma speciale brevettata
- Base con "asole" per aggancio "clip" veloce brevettata
- Un solo taglio della base per fare l'angolo
- Un unico prodotto autolivellante o fisso, grazie all'inserimento del "blocco testa"
- Non servono anelli, tubi o prolunghe aggiuntive, la prolunga è integrata ed ergonomica
- Compatibile con tutti gli accessori della gamma Pedestal/Grid Raised Floor/Woodeck
- Spese di trasporto considerevolmente ridotte dato che il prodotto viene fornito assemblato

- *From 30 mm to 420 mm in height with only three products*
- *A single product with all the integrated elements*
- *Reduction of warehouse space*
- *300 cm² solid base with patented special shape*
- *Base with "slots" for fast "clip" attachment patented*
- *A single cut of the base to make the corner*
- *A single self-leveling or fixed product, thanks to the insertion of the "head block"*
- *No additional rings, tubes or extensions are needed, the extension is integrated and ergonomic*
- *Compatible with all accessories of the Pedestal/Grid Raised Floor/Woodeck range*
- *Transport costs considerably reduced as the product is supplied assembled*

Supporto Pedestal Prime® per travetto in alluminio

Pedestal Prime® support for aluminium joist



CODICE CODE	DESCRIZIONE DESCRIPTION	MISURA SIZE	PAG. LISTINO PRICE LIST PAGE	PZ 	PZ 	
					Italia	Abroad
E505030065	PR 1 con testa autolivellante Ø 110 mm per travetto in alluminio <i>PR 1 with self-leveling head Ø 110 mm for aluminium joist</i>	30-65 mm	5	25	1200	1350
E505060155	PR 2 con testa autolivellante Ø 110 mm per travetto in alluminio <i>PR 2 with self-leveling head Ø 110 mm for aluminium joist</i>	65-155 mm	5	25	600	750
E505150420	PR 3 con testa autolivellante Ø 110 mm per travetto in alluminio <i>PR 3 with self-leveling head Ø 110 mm for aluminium joist</i>	155-420 mm	5	12	288	336
E501000190	Prolunga PR* <i>PR Extension*</i>	-	5	12	504	576

* Utilizzabile con PR3.

* Usable with PR3.



Supporto Pedestal Prime® per travetto in legno
Pedestal Prime® support for decking



Dettaglio: aletta preincisa
 Detail: pre-cut flap

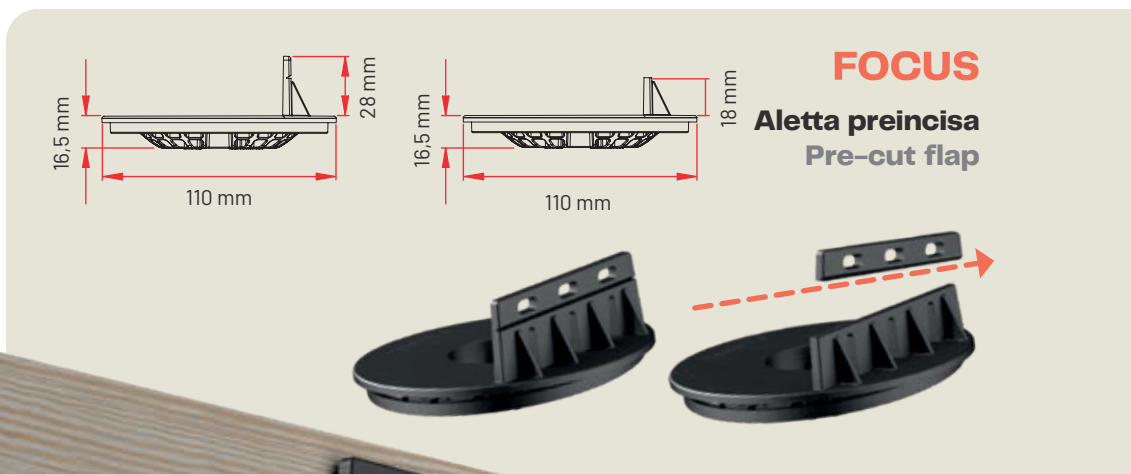

Dettaglio testa avvitata
 su travetto in legno
 Detail head screwed onto wooden joist



Supporto Pedestal Prime® per travetto in legno Pedestal Prime® support for decking



CODICE CODE	DESCRIZIONE DESCRIPTION	MISURA SIZE	PAG. LISTINO PRICE LIST PAGE	PZ 	PZ 	
					Italia	Abroad
E504030065	PR 1 con testa autolivellante Ø 110 mm per travetto in legno <i>PR 1 with self-leveling head Ø 110 mm for decking</i>	30-65 mm	6	25	1200	1350
E504060155	PR 2 con testa autolivellante Ø 110 mm per travetto in legno <i>PR 2 with self-leveling head Ø 110 mm for decking</i>	65-155 mm	6	25	600	750
E504150420	PR 3 con testa autolivellante Ø 110 mm per travetto in legno <i>PR 3 with self-leveling head Ø 110 mm for decking</i>	155-420 mm	6	12	288	336
E501000190	Prolunga PR* <i>PR Extension*</i>	-	6	12	504	576

* Utilizzabile con PR3.

* Usable with PR3.



Dettaglio del blocco automatico della rotazione

Detail of automatic lock of the rotation



Con travetto di alluminio

With aluminium joist

- 1 Gomma antirumore e antiscivolo
Non-slip and anti-noise rubber
- 2 Fermi per il blocco automatico della rotazione
Stops for the automatic locking of the rotation

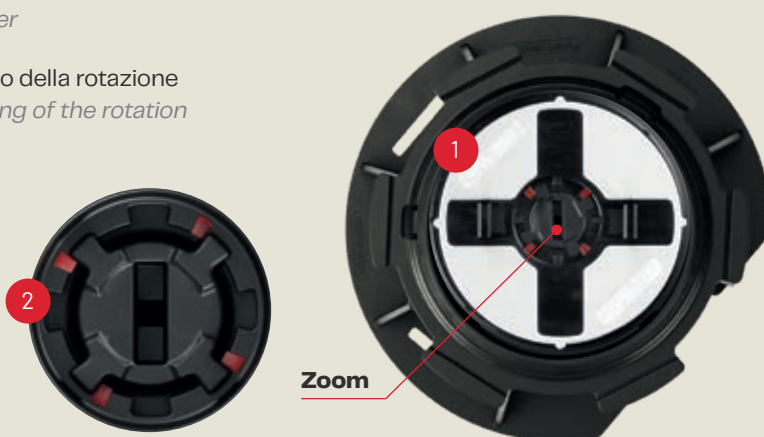

Con travetto di legno

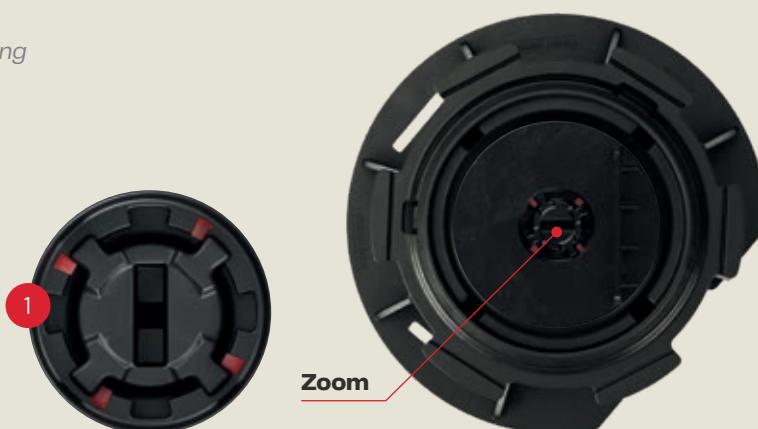

With wooden joist

- 1 Fermi per il blocco automatico della rotazione
Stops for the automatic locking of the rotation



Supporto Pedestal Prime®
(Base + Vite + Prolunga integrata)
Pedestal Prime® support
(Base + Screw + Integrated extension)

TESTA ESCLUSA**HEAD EXCLUDED**

CODICE BASE + VITE + PROLUNGA INTEGRATA CODE BASE + SCREW + INTEGRATED EXTENSION	DESCRIZIONE DESCRIPTION	MISURA SIZE	PAG. LISTINO PRICE LIST PAGE	PZ 	PZ 
E502030065	PR 1 base + vite + prolunga integrata <i>PR 1 base + screw + integrated extension</i>	30-65 mm*	7	25	1350
E502060155	PR 2 base + vite + prolunga integrata <i>PR 2 base + screw + integrated extension</i>	65-155 mm*	7	25	750
E502150420	PR 3 base + vite + prolunga integrata <i>PR 3 base + screw + integrated extension</i>	155-420 mm*	7	12	360
E035101204	Testa bicomponente autolivellante, aletta 4 mm H 12 mm <i>Two-component self leveling head, 4 mm tab H 12 mm</i>	Ø 110 mm	7	200	6400
E035100010	Testa bicomponente autolivellante per travetto alluminio <i>Two-component self-leveling head for aluminium joist</i>	Ø 110 mm	7	200	6400
E035102530	Testa autolivellante per travetto in legno <i>Self-leveling head for decking</i>	Ø 110 mm	7	100	4200
E035201204	Testa XL bicomponente autolivellante, aletta 4 mm H 12 mm** <i>Two-component self-leveling XL head, 4 mm tab H 12 mm**</i>	Ø 150 mm	7	100	3200
E035203001	Testa bicomponente autolivellante a incrocio per travetto alluminio <i>Two-component self-leveling Criss-cross head for aluminium joist</i>	Ø 130 mm	7	150	4800
E036000100	Blocco testa basculante <i>Locking system</i>	-	7	800****	-
E501000190	Prolunga PR*** <i>PR Extension***</i>	-	7	12	-

Testa alette 2-3 mm o testa liscia a richiesta.

I codici dei supporti comprendono base, vite e prolunga integrata senza testa.

* Le misure indicate si riferiscono a Base + Vite + Prolunga integrata + Testa Ø 110 mm autolivellante bicomponente.

** L'altezza dei supporti PR aumenta di 2 mm.

*** Utilizzabile con PR3.

**** In sacchetti da 100 pz.

Tab head 2-3 mm or plane head upon request.

The codes for the supports include the base, the screw, the integrated extension without the head.

** The measurements indicated refer to Base + Screw + Integrated extension + Self-leveling two-component head Ø 110 mm.*

*** With XL head, height of all the PR range increases of 2 mm.*

**** Usable with PR3.*

***** Bags of 100 pcs.*



SR/SRT

Supporto Reversus®

Reversus® support

BREVETTATO

PATENTED



Reversus®

SR/SRT

Il primo supporto al mondo con testa reversibile

The world's first support with a reversible head



Testa reversibile: un'unica testa per 3 soluzioni di posa
Reversible head: a single head for 3 laying solutions



Base con rottura facilitata per una posa più rapida
Base with easy break for faster installation

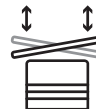

Testa fissa che si trasforma in autolivellante per compensare pendenze fino al 5%
Fixed head that transforms into a self-leveling head to compensate slopes up to 5%



Guarda il video di presentazione



Watch the presentation video

La grande novità di questo nuovo supporto è la testa reversibile in bi-componente (PP + gomma), da un lato ha le alette per la posa delle lastre e dall'altro lato è predisposta per la posa dei travetti in alluminio e legno. Inoltre, se non utilizzi mai il travetto puoi avere la testa reversibile con alette da 4 mm da un lato e alette da 2 mm dall'altro.

The great novelty of this new support is the reversible head in two-component (PP + rubber), on one side it has the tabs for laying the slabs and on the other side it is designed for the laying of aluminum and wooden joists. Also, if you never use the joist you can have the reversible head with 4 mm tabs on one side and 2 mm tabs on the other.



Testa in bimateriale (PP+gomma) per lastre
Two-component head (PP+rubber) for slabs

Testa in bimateriale (PP+gomma) per travetto
Two-component head (PP+rubber) for joist

SR/SRT

Vantaggi Advantages



- Testa reversibile 3 in 1: con una sola testa si possono posare sia le lastre che il decking o scegliere se avere le fughe da 4 mm o da 2 mm.
- Due misure di Testa, diametro 110 mm e diametro 150 mm (XL).
- Testa in bi-materiale (PP + gomma) con alette facilmente asportabili.
- Base rotonda con rottura facilitata: la base è facilmente modificabile a seconda delle esigenze grazie alla rottura facilitata dei vari settori circolari, in un attimo la base sarà pronta per essere utilizzata a bordo parete, con le clip o con il profilo verticale perimetrale, senza l'utilizzo di utensili ma con una semplice pressione manuale.
- Elemento "basculante", è un componente aggiuntivo che si aggancia sotto alla testa formandone un corpo unico, rende il supporto stesso "basculante autolivelante" fino a compensare il 5% di pendenza, aumenta l'altezza del supporto di soli 5 mm.
- Prolunga: consente di aumentare l'altezza del supporto in modo semplice e veloce.
- È compatibile con tutti gli accessori delle linee Pedestal, Grid Raised Floor e Woodeck.
- *3 in 1 reversible head: with a single head you can lay both slabs and decking or choose whether to have 4 mm or 2 mm joints.*
- *Two Head sizes, 110 mm diameter and 150 mm diameter (XL).*
- *Head in bi-material (PP + rubber) with easily removable tabs.*
- *Round base with easy breaking, the base is easily modified according to needs thanks to the easy breaking of the various circular sectors, in a moment the base will be ready to be used on the edge of the wall, with the clips or with the vertical perimeter profile, without the use of any tools, with a simple manual pressure.*
- *"Tilting" element, it is an add-on component that hooks under the head forming a single body. It makes the support "self-levelling tilting" to compensate up to a 5% slope and it increases the height of the support by only 5 mm.*
- *Extension: it allows to increase the height of the support in a simple and quick way.*
- *SR support is compatible with all the accessories of the Pedestal, Grid Raised Floor and Woodeck lines.*

SR/SRT

Descrizione componenti Components description



Testa in bicomponente
(PP+gomma) per lastre
*Two-component head
(PP+rubber) for slabs*



Testa in bicomponente
(PP+gomma) per travetto
*Two-component head
(PP+rubber) for joist*

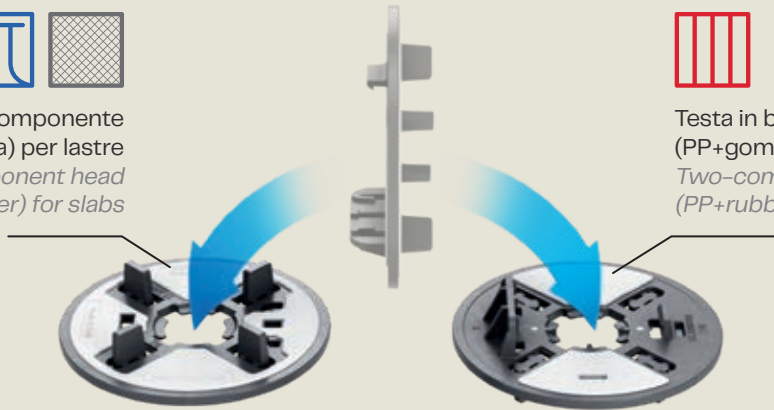

Accessorio per rendere basculante
la testa (opzionale)
*Accessory to make the head tilt
(optional)*

Aggancio testa-vite
Coupling head to screw attachment system

Vite
Screw

Prolunga (opzionale)
Extension (optional)

Sistema di blocco
dei componenti
Block System

Base con rottura facilitata
Easy-break base

Fori scarico acqua
Water drainage holes

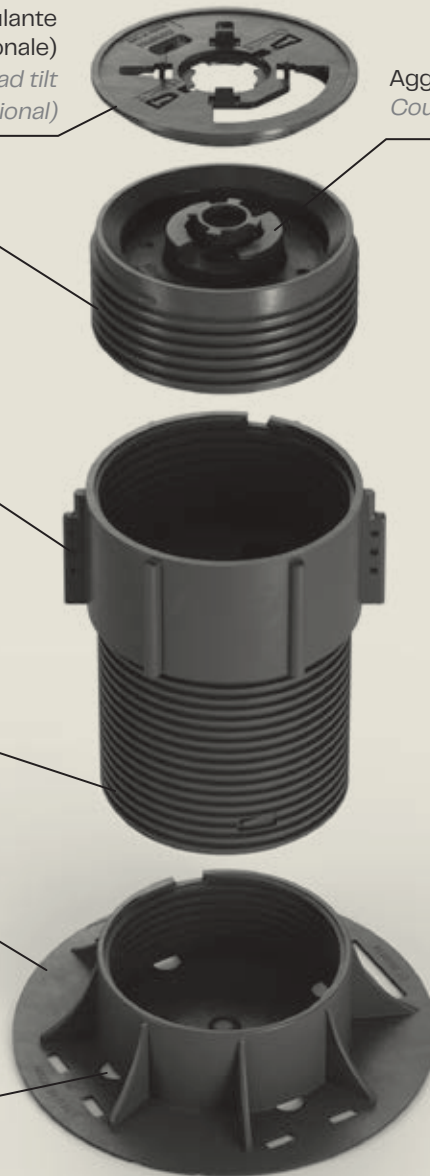

FOCUS

Accessorio per rendere
basculante la testa
*Accessory to make
the head tilt*



FOCUS

Base con rottura facilitata
Easy-break base



SR/SRT

Asole per l'inserimento della clip di tamponamento verticale

Slots to fit the vertical lining base clip

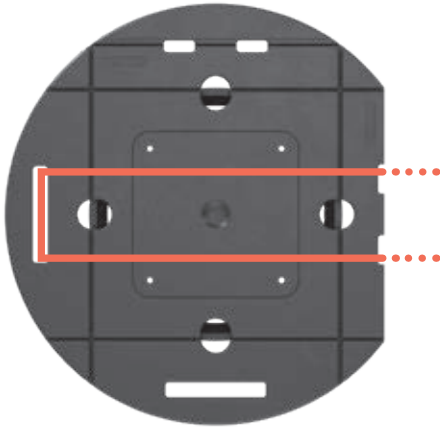

La base del supporto presenta due asole adatte all'inserimento della clip di base in acciaio inox, al fine di realizzare il tamponamento verticale.

The base of the support has two slots suitable for inserting the stainless steel base clip, in order to create the vertical buffer.

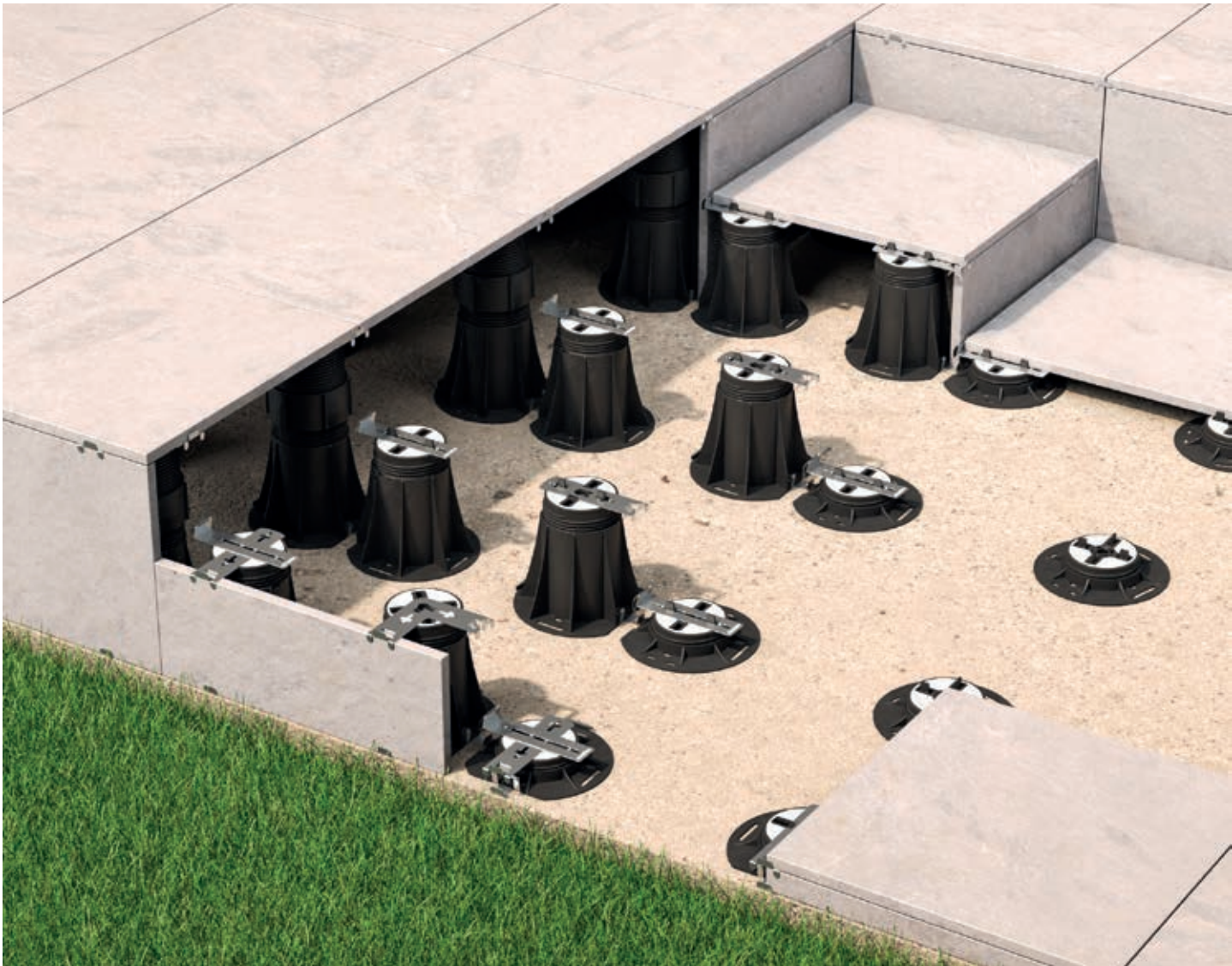

Le teste: una soluzione 3 in 1

The heads: a 3-in-1 solution

BREVETTATO

PATENTED

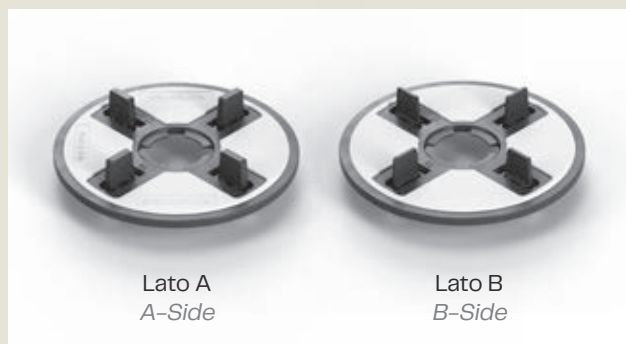
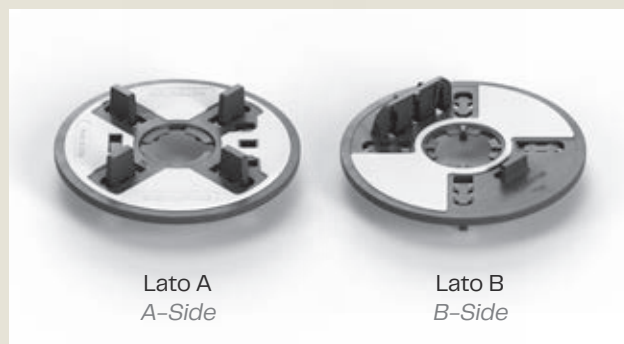
Lato A
A-SideLato B
B-SideLato A
A-SideLato B
B-Side

SR

La testa reversibile SR è predisposta per la posa delle lastre mono e multi formato con alette di spessore 4 mm da un lato e 2 mm dall'altro.

Questa versione di testa è indicata per coloro che posano esclusivamente lastre mono e multiformato, in questo caso si potrà scegliere all'ultimo momento, anche in cantiere stesso, se utilizzare le alette da 4 mm o quelle da 2 mm.

The reversible SR head is set up for laying single and multi-format slabs, with 4 mm thick tabs.

This version of the head is suitable for those who only lay single and multi-format slabs, in this case you can choose from all last moment, even on the construction site itself, whether to use the 4 mm tabs or the 2 mm ones.

SRT

Un lato della testa reversibile è predisposto per la posa del travetto di alluminio e legno. Il travetto di alluminio si inserisce a scatto con una semplice pressione delle mani mentre il travetto in legno si appoggia alla parete verticale e si fissa con le normali viti autofilettanti. All'occorrenza c'è la possibilità di utilizzare la testa a incrocio per travetto in alluminio. L'altro lato della testa è predisposto per la posa delle lastre con alette da 4 mm.

One side of the reversible head is designed for the installation of the aluminum and wooden joist. The aluminum joist snaps into place with a simple pressure of the hands while the wooden joist leans against the vertical wall and is fixed with the normal self-threading screws. If necessary, there is the possibility of using the cross head for aluminum joists. The other side of the head is designed for laying slabs with 4 mm thick tabs.

CODICE CODE	DESCRIZIONE DESCRIPTION	MISURA SIZE	PAG. LISTINO PRICE LIST PAGE	PZ 	PZ 
E030001010	Testa reversibile alette 4 mm / Travetto in alluminio e legno <i>Reversible head with 4 mm tabs / aluminium and wooden joist</i>	Ø 110 mm	10	200	6400
E030001020	Testa reversibile alette 4/2 mm H 12 mm <i>Reversible head tabs 4/2 mm H 12 mm</i>	Ø 110 mm	10	200	6400
E030001030	Testa reversibile alette 4 mm / Travetto in alluminio e legno <i>Reversible head with 4 mm tabs / aluminium and wooden joist</i>	Ø 150 mm	10	100	3200
E030001040	Testa reversibile alette 4/2 mm H 12 mm <i>Reversible head tabs 4/2 mm H 12 mm</i>	Ø 150 mm	10	100	3200

SR

Supporto con testa reversibile
Reversus® per posa lastre direttamente
sui supporti o su griglia

Reversus® support with reversible
head for laying slabs directly on supports
or on a grid

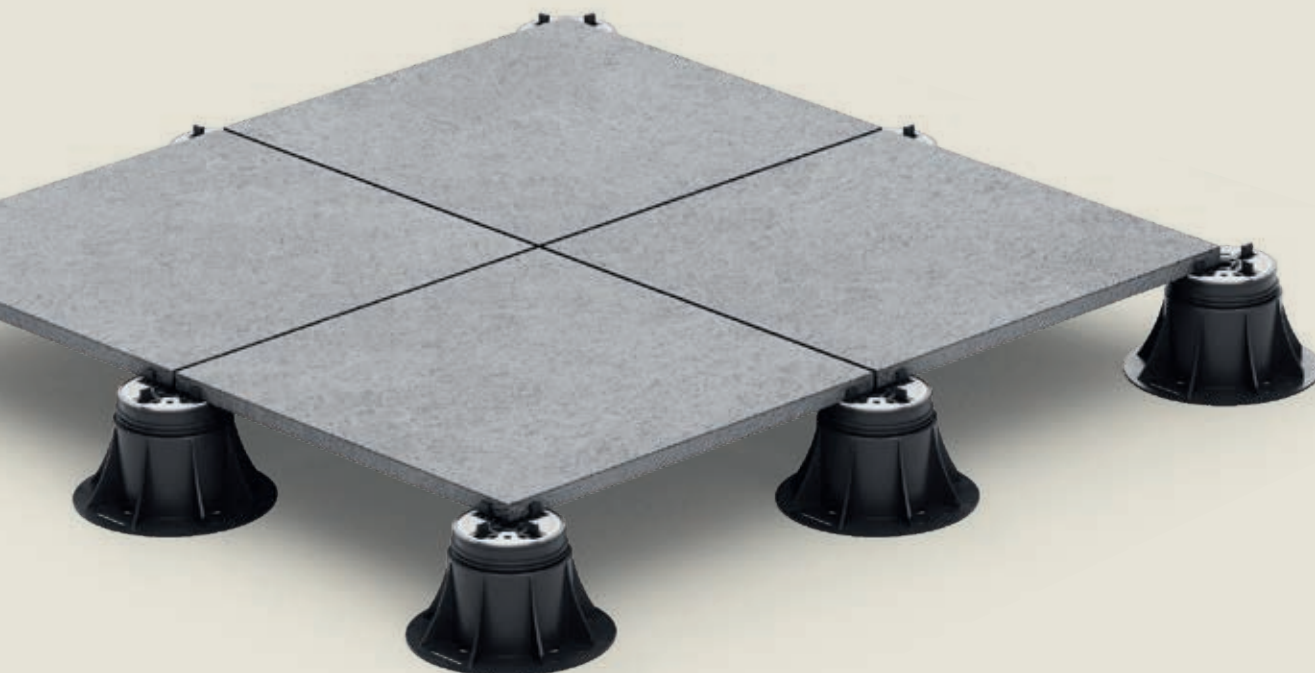

CODICE CODE	TIPO TYPE	MISURA SIZE	TESTA REVERSIBILE REVERSIBLE HEAD		PAG. LISTINO PRICE LIST PAGE	PZ 	PZ 	
			Lato A A-Side	Lato B B-Side			Italy	Abroad
E030020304	SR 1	26-38 mm	Aletta 4 mm - H 12 mm <i>4 mm tab - H 12 mm</i>	Aletta 2 mm - H 12 mm <i>Tabs 2 mm H 12 mm</i>	8	20	1200	1320
E030020406	SR 2	38-60 mm	Aletta 4 mm - H 12 mm <i>4 mm tab - H 12 mm</i>	Aletta 2 mm - H 12 mm <i>Tabs 2 mm H 12 mm</i>	8	20	840	960
E030020610	SR 3	59-100 mm	Aletta 4 mm - H 12 mm <i>4 mm tab - H 12 mm</i>	Aletta 2 mm - H 12 mm <i>Tabs 2 mm H 12 mm</i>	8	20	600	720
E030020916	SR 4	93-162 mm	Aletta 4 mm - H 12 mm <i>4 mm tab - H 12 mm</i>	Aletta 2 mm - H 12 mm <i>Tabs 2 mm H 12 mm</i>	8	20	480	480
E030021628	SR 5	158-280 mm	Aletta 4 mm - H 12 mm <i>4 mm tab - H 12 mm</i>	Aletta 2 mm - H 12 mm <i>Tabs 2 mm H 12 mm</i>	8	20	360	420



Il codice si riferisce al supporto completo di testa SR
aletta 4 mm H 12 mm/aletta 2 mm H 12 mm Ø 110 mm.

The code refers to the support with SR head tabs 4 mm
H 12 mm/tabs 2 mm H 12 mm Ø 110 mm.

SRT

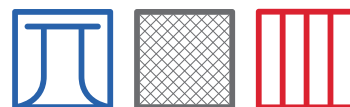
Supporto con testa reversibile Reversus® per posa con travetto in alluminio o legno e per posa lastre direttamente sui supporti o su griglia Reversus® support with reversible head for laying with aluminum/wooden joist and for laying slabs directly on supports or on a grid



CODICE CODE	TIPO TYPE	MISURA SIZE	TESTA REVERSIBILE REVERSIBLE HEAD		PAG. LISTINO PRICE LIST PAGE	PZ 	PZ 	
			Lato A A-Side	Lato B B-Side			Italy	Abroad
E030010304	SRT 1	26-38 mm	Aletta 4 mm - H 12 mm 4 mm tab - H 12 mm	Travetto alluminio/legno Aluminium / wood joist	9	20	1200	1320
E030010406	SRT 2	38-60 mm	Aletta 4 mm - H 12 mm 4 mm tab - H 12 mm	Travetto alluminio/legno Aluminium / wood joist	9	20	840	960
E030010610	SRT 3	59-100 mm	Aletta 4 mm - H 12 mm 4 mm tab - H 12 mm	Travetto alluminio/legno Aluminium / wood joist	9	20	600	720
E030010916	SRT 4	93-162 mm	Aletta 4 mm - H 12 mm 4 mm tab - H 12 mm	Travetto alluminio/legno Aluminium / wood joist	9	20	480	480
E030011628	SRT 5	158-280 mm	Aletta 4 mm - H 12 mm 4 mm tab - H 12 mm	Travetto alluminio/legno Aluminium / wood joist	9	20	360	420

Il codice si riferisce al supporto completo di testa SRT lastre aletta 4 mm H 12 mm/travetto Ø 110 mm.

The code refers to the support with slab tab 4 mm H 12 mm/joist SRT head Ø 110 mm.

Per arrivare sempre più in alto To get higher and higher



Il supporto SR/SRT prevede la possibilità di utilizzare una o più prolunghere al fine di raggiungere le altezze desiderate.

The SR/SRT support provides the possibility of using one or more extensions in order to reach the desired heights.

REVERSUS
ETERNAL



SR/SRT 1
26 - 38 mm



SR/SRT 2
38 - 60 mm



SR/SRT 3
59 - 100 mm



SR/SRT 4
93 - 162 mm



SR/SRT 5
158 - 280 mm



**SR/SRT 3
+ 2 PNM**
275 - 385 mm



**SR/SRT 3
+ 3 PNM**
381 - 528 mm



**SR/SRT 4
+ 1 PNM**
201 - 305 mm



**SR/SRT 4
+ 2 PNM**
308 - 449 mm



**SR/SRT 5
+ 1 PNM**
311 - 422 mm



**SR/SRT 5
+ 2 PNM**
418 - 565 mm

Supporto Reversus® (Base + Vite) Reversus® support (Base + Screw)

TESTA ESCLUSA**HEAD EXCLUDED**

CODICE BASE + VITE CODE BASE + SCREW	DESCRIZIONE DECIPTION	MISURA SIZE	PAG. LISTINO PRICE LIST PAGE	PZ 	PZ 	
					Italy	Abroad
E030030304	SRT - SR 1 base + vite <i>SRT - SR 1 base + screw</i>	26-38 mm*	10	20	1200	1320
E030030406	SRT - SR 2 base + vite <i>SRT - SR 2 base + screw</i>	38-60 mm*	10	20	840	960
E030030610	SRT - SR 3 base + vite <i>SRT - SR 3 base + screw</i>	59-100 mm*	10	20	600	720
E030030916	SRT - SR 4 base + vite <i>SRT - SR 4 base + screw</i>	93-162 mm*	10	20	480	480
E030031628	SRT - SR 5 base + vite <i>SRT - SR 5 base + screw</i>	158-280 mm*	10	20	360	420
E030001010	Testa reversibile alette 4 mm / Travetto in alluminio e legno <i>Reversible head with 4 mm tabs / aluminium and wooden joist</i>	Ø 110 mm	10	200	6400	
E030001020	Testa reversibile alette 4/2 mm H 12 mm <i>Reversible head tabs 4/2 mm H 12 mm</i>	Ø 110 mm	10	200	6400	
E030001030	Testa reversibile alette 4 mm / Travetto in alluminio e legno <i>Reversible head with 4 mm tabs / aluminium and wooden joist</i>	Ø 150 mm	10	100	3200	
E030001040	Testa reversibile alette 4/2 mm H 12 mm <i>Reversible head tabs 4/2 mm H 12 mm</i>	Ø 150 mm	10	100	3200	



I codici dei supporti comprendono base e vite, senza testa.

* Le misure indicate si riferiscono a Base + Vite + Testa Ø 110 mm autolivellante bicomponente.

The codes for the supports include the base and the screw, without the head.

* The measurements indicated refer to Base + Screw + Self-leveling two-component head Ø 110 mm.

Elementi aggiuntivi Addictional elements

CODICE CODE	DESCRIZIONE DECIPTION	MISURA SIZE	PAG. LISTINO PRICE LIST PAGE	PZ 	PZ 
E030001000	Accessorio per rendere basculante la testa al 5%* <i>Accessory to make the head tilting up to 5%*</i>	Ø 110 - 150 mm	10	200	6400
Q193000203	Viti a croce per fissaggio travetto in legno <i>Cross screws for fixing wooden joist</i>	Ø 3,5 mm L 20 mm	10	1000	-

* Aumenta l'altezza del supporto di 5 mm.

* It increases the height of the support by 5 mm.

SE

Supporto Eterno

Eterno support



Base con rottura facilitata
per una posa più rapida
*Base with easy break for faster
installation*



330 cm²

Base di appoggio liscia di 330 cm²
Smooth support base of 330 cm²



Blocchi di sicurezza antisvitamento
Anti-unscrewing safety blocks



SE

Supporto regolabile autolivellante Eterno

Eterno adjustable and self-leveling support



Un unico prodotto autolivellante o fisso, grazie all'inserimento del "blocco testa"

A single self-leveling or fixed product, thanks to the insertion of the "head block"



Spese di trasporto considerevolmente ridotte dato che il prodotto viene fornito assemblato

Transport costs considerably reduced as the product is supplied assembled

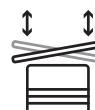

Testa autolivellante che compensa automaticamente pendenze fino al 5%

Self-leveling head that automatically compensates up to 5% slopes



Guarda il video di presentazione



Watch the presentation video

È stato il primo. È tuttora unico.

Il supporto regolabile Eterno SE con testa basculante è stato il primo di una lunga serie di supporti per pavimenti sopraelevati da esterno. Il suo pregio: unire tecnicità, esteticità e praticità di posa dei pavimenti da esterno.

Si è imposto come l'unica soluzione al mondo capace di contrastare la pendenza dei piani di posa. Un risultato che si ottiene grazie al movimento basculante della testa, che compensa pendenze fino al 5%.

La regolazione avviene con una chiave che agisce dall'alto, anche a pavimentazione montata, e garantisce una registrazione millimetrica di tutta la pavimentazione.

I suoi numerosi altri vantaggi sono sperimentati da progettisti, costruttori e posatori che ogni giorno nel mondo utilizzano questo sistema insuperabile.

It was, and still is, one of a kind.

The Eterno SE adjustable support with a tilting head was the first in a long line of supports for exterior floating floors. It's a raised flooring product that combines superb technical features and exceptional aesthetics with maximum ease of installation.

It has come to be recognized as the market's most exclusive solution for dealing with sloping installation surfaces. In this regard, the product is capable of providing exceptional results thanks to its tilting movement, which is capable of compensating for slopes of up to 5%.

The adjustment is performed using the adjustment key, which can be applied from above once the flooring has been installed and guarantees the precision alignment of the entire floor surface.

This unrivalled product also boasts numerous additional advantages, which are enjoyed every day around the globe by architects, builders and installers alike.



Supporto con portata certificata
Tested for loading bearing capacity

SE**Vantaggi
Advantages**

- Testa autolivellante che compensa automaticamente pendenze fino al 5%.
- Testa con parte superiore in gomma antirumore e antiscivolo.
- Alette facilmente asportabili.
- Regolabile da 28 a 550 mm, anche a pavimento finito, grazie all'esclusiva chiave di regolazione.
- Base di appoggio con rottura facilitata liscia di 330 cm².
- Resistente a temperature da -40°C a +80°C.
- Resistente agli agenti atmosferici, agli acidi, all'invecchiamento, ai raggi UV.
- Utilizzabile con qualsiasi pavimentazione da esterno autoportante.
- Totalmente riciclabile.
- Test di carico a rottura certificati.
- *Self-leveling head that automatically compensates slopes up to 5%.*
- *Head with top in soft non-slip and anti-noise rubber.*
- *Tabs easy to remove.*
- *Adjustable height from 28 to 550 mm once pavement is finished thanks to exclusive adjusting key.*
- *330 cm² easy track and smooth basis.*
- *Resistant to temperatures between -40°C to 80°C.*
- *Resistant to weathering, acids, UV rays and wear and tear.*
- *Suitable to any self-supporting outdoor paving system.*
- *Entirely recyclable.*
- *Test of tensile strength certified.*

SE

Descrizione componenti Components description



FOCUS

Base di appoggio
con rottura facilitata
Easy-break base



SE

Teste compatibili

Compatible heads

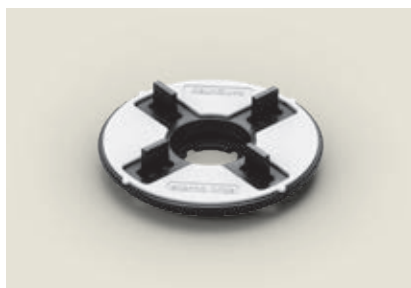

Testa basculante Ø 110 mm aletta 4 mm H 12 mm

Testa per la posa delle lastre direttamente su supporto o con griglia. Su richiesta spessore alette 2 o 3 mm.

Self-leveling head Ø 110 mm tab 4 mm H 12 mm

The head is designed for laying slabs directly on the support or with a grid system. On request, the tabs can be customized with a thickness of 2 or 3 mm.



Testa basculante Ø 110 mm per travetto in alluminio

L'aggancio con le sue specifiche alette, permette di accogliere il travetto senza necessità di ulteriori fissaggi.

Self-leveling head Ø 110 mm for aluminium joist

The attachment with its specific tabs allows the joist to be accommodated without the need for additional fixings.

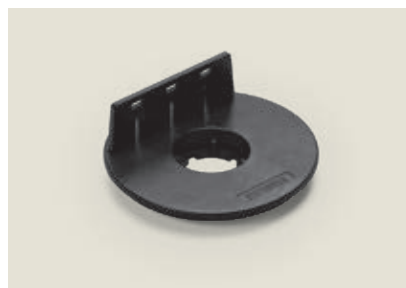



Testa basculante Ø 110 mm per travetto in legno

L'aletta laterale permette di accogliere con la massima semplicità di fissaggio e rapidità di installazione tutte le tipologie di sottostrutture.

Self-leveling head Ø 110 mm for decking

The lateral flap allows for the easiest and fastest installation of all types of substructures, ensuring maximum simplicity in the attachment process.

CODICE CODE	DESCRIZIONE DESCRIPTION	MISURA SIZE	PAG. LISTINO PRICE LIST PAGE	PZ 	PZ 
E035101204	Testa bicomponente autolivellante, aletta 4 mm H 12 mm <i>Two-component self-leveling head, 4 mm tab H 12 mm</i>	Ø 110 mm	15	200	6400
E035100010	Testa bicomponente autolivellante per travetto alluminio <i>Two-component self-leveling head for aluminium joist</i>	Ø 110 mm	15	200	6400
E035102530	Testa autolivellante per travetto in legno <i>Self-leveling head for decking</i>	Ø 110 mm	15	100	4200

SE

Teste compatibili

Compatible heads



Testa basculante XL Ø 150 mm aletta 4 mm H 12 mm

Con il diametro di 150 mm offre una superficie d'appoggio superiore allo standard.
Su richiesta spessore alette 2 o 3 mm.

Self-leveling XL head Ø 150 mm tab 4 mm H 12 mm

With a diameter of 150 mm, it provides a larger support surface compared to the standard size. On request, tab thickness can be 2 or 3 mm.



Testa basculante Ø 130 mm ad incrocio per travetti in alluminio

Può essere utilizzata in sostituzione della classica testa per travetto in alluminio per l'appoggio fino a 4 travetti contemporaneamente.

Self-leveling Criss-cross head Ø 130 mm for aluminium joist

It can be used as a replacement for the classic head for aluminum joists, allowing support for up to 4 joists simultaneously.

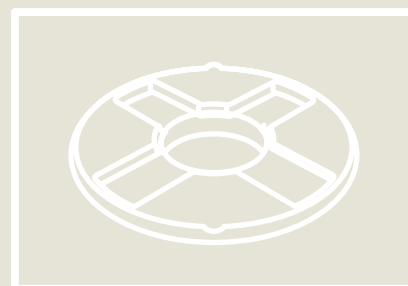

Teste speciali per utilizzi particolari

Sono disponibili teste speciali per l'aggancio anti-vento delle lastre o autoestinguenti.

Special heads for specific uses/applications

Special heads are available for the windproof attachment of the slabs or self-extinguishing purposes.

CODICE CODE	DESCRIZIONE DESCRIPTION	MISURA SIZE	PAG. LISTINO PRICE LIST PAGE	PZ 	PZ 
E035201204	Testa XL bicomponente autolivellante, aletta 4 mm H 12 mm <i>Two-component self-leveling XL head, 4 mm tab H 12 mm</i>	Ø 150 mm	15	100	3200
E035203001	Testa bicomponente autolivellante a incrocio per travetto alluminio <i>Two-component self-leveling Criss-cross head for aluminium joist</i>	Ø 130 mm	15	150	4800
E036000100	Blocco testa basculante <i>Locking system</i>	-	15	800*	-

* In sacchetti da 100 pz.

* Bags of 100 pcs.

Schema composizione SEO - SE14
Composition table SEO - SE14

SE0 = SE0	SE8 = SE5 + 1xP1
SE1 = SE1	SE9 = SE3 + 2xP1
SE2 = SE2	SE10 = SE4 + 2xP1
SE3 = SE3	SE11 = SE5 + 2xP1
SE4 = SE4	SE12 = SE3 + 3xP1
SE5 = SE5	SE13 = SE4 + 3xP1
SE6 = SE3 + 1xP1	SE14 = SE5 + 3xP1
SE7 = SE4 + 1xP1	-





Prolunga P1
P1 extension



Supporto Eterno per posa lastre
direttamente sui supporti o su griglia

Eterno support for laying slabs
directly on supports or on a grid



CODICE CODE	DESCRIZIONE DESCRIPTION	MISURA SIZE	PAG. LISTINO PRICE LIST PAGE	PZ 	PZ 
E240028038	SE 0 con testa autolivellante Ø 110 mm, aletta 4 mm H 12 mm <i>SE 0 with self-leveling head Ø 110 mm, tab 4 mm H 12 mm</i>	28-38 mm	12	25	1500
E240037050	SE 1 con testa autolivellante Ø 110 mm, aletta 4 mm H 12 mm <i>SE 1 with self-leveling head Ø 110 mm, tab 4 mm H 12 mm</i>	37,5-50 mm	12	25	1200
E240050075	SE 2 con testa autolivellante Ø 110 mm, aletta 4 mm H 12 mm <i>SE 2 with self-leveling head Ø 110 mm, tab 4 mm H 12 mm</i>	50-75 mm	12	25	1200
E240075120	SE 3 con testa autolivellante Ø 110 mm, aletta 4 mm H 12 mm <i>SE 3 with self-leveling head Ø 110 mm, tab 4 mm H 12 mm</i>	75-120 mm	12	25	800
E240120170	SE 4 con testa autolivellante Ø 110 mm, aletta 4 mm H 12 mm <i>SE 4 with self-leveling head Ø 110 mm, tab 4 mm H 12 mm</i>	120-170 mm	12	25	600
E240170215	SE 5 con testa autolivellante Ø 110 mm, aletta 4 mm H 12 mm <i>SE 5 with self-leveling head Ø 110 mm, tab 4 mm H 12 mm</i>	170-215 mm	12	25	600
E240140230	SE 6 con testa autolivellante Ø 110 mm, aletta 4 mm H 12 mm <i>SE 6 with self-leveling head Ø 110 mm, tab 4 mm H 12 mm</i>	140-230 mm	12	-	-
E240185275	SE 7 con testa autolivellante Ø 110 mm, aletta 4 mm H 12 mm <i>SE 7 with self-leveling head Ø 110 mm, tab 4 mm H 12 mm</i>	185-275 mm	12	-	-
E240235325	SE 8 con testa autolivellante Ø 110 mm, aletta 4 mm H 12 mm <i>SE 8 with self-leveling head Ø 110 mm, tab 4 mm H 12 mm</i>	235-325 mm	12	-	-
E240205345	SE 9 con testa autolivellante Ø 110 mm, aletta 4 mm H 12 mm <i>SE 9 with self-leveling head Ø 110 mm, tab 4 mm H 12 mm</i>	205-345 mm	12	-	-
E240250385	SE 10 con testa autolivellante Ø 110 mm, aletta 4 mm H 12 mm <i>SE 10 with self-leveling head Ø 110 mm, tab 4 mm H 12 mm</i>	250-385 mm	12	-	-
E240300400	SE 11 con testa autolivellante Ø 110 mm, aletta 4 mm H 12 mm <i>SE 11 with self-leveling head Ø 110 mm, tab 4 mm H 12 mm</i>	300-400 mm	12	-	-
E240270455	SE 12 con testa autolivellante Ø 110 mm, aletta 4 mm H 12 mm <i>SE 12 with self-leveling head Ø 110 mm, tab 4 mm H 12 mm</i>	270-455 mm	12	-	-
E240315500	SE 13 con testa autolivellante Ø 110 mm, aletta 4 mm H 12 mm <i>SE 13 with self-leveling head Ø 110 mm, tab 4 mm H 12 mm</i>	315-500 mm	12	-	-
E240365550	SE 14 con testa autolivellante Ø 110 mm, aletta 4 mm H 12 mm <i>SE 14 with self-leveling head Ø 110 mm, tab 4 mm H 12 mm</i>	365-550 mm	12	-	-
E130125000	Prolunga P1 * <i>P1 Extension*</i>	-	12	25	1050

Testa alette 2-3 mm o testa liscia a richiesta.

* Prolunga utilizzabile solo con supporti SE3, SE4 e SE5.

Tab head 2-3 mm or plane head upon request.

* Extension element suitable only to types SE3, SE4 and SE5.

Supporto Eterno per posa con travetto in alluminio Eterno support for laying with an aluminum joist





- Testa autolivellante che compensa automaticamente pendenze fino al 5%.
- Testa con parte superiore in gomma antirumore e antiscivolo.
- Alette facilmente asportabili.
- Regolabile da 28 a 550 mm, anche a pavimento finito, grazie all'esclusiva chiave di regolazione.
- Base di appoggio con rottura facilitata liscia di 330 cm².
- Resistente a temperature da -40°C a +80°C.
- Resistente agli agenti atmosferici, agli acidi, all'invecchiamento, ai raggi UV.
- Utilizzabile con qualsiasi pavimentazione da esterno autoportante.
- Totalmente riciclabile.
- Test di carico a rottura certificati.
- Self-leveling head that automatically compensates slopes up to 5%.
- Head with top in soft non-slip and anti-noise rubber.
- Tabs easy to remove.
- Adjustable height from 28 to 550 mm once pavement is finished thanks to exclusive adjusting key.
- 330 cm² easy track and smooth basis.
- Resistant to temperatures between -40°C to 80°C.
- Resistant to weathering, acids, UV rays and wear and tear.
- Suitable to any self-supporting outdoor paving system.
- Entirely recyclable.
- Test of tensile strength certified.

Supporto Eterno per posa con travetto in alluminio

Eterno support for laying with an aluminum joist



CODICE CODE	DESCRIZIONE DESCRIPTION	MISURA SIZE	PAG. LISTINO PRICE LIST PAGE	PZ 	PZ 
E250028038	SE 0 con testa autolivellante Ø 110 mm per travetto in alluminio <i>SE 0 with self-leveling head Ø 110 mm for aluminium joist</i>	28 - 38 mm	13	25	1500
E250037050	SE 1 con testa autolivellante Ø 110 mm per travetto in alluminio <i>SE 1 with self-leveling head Ø 110 mm for aluminium joist</i>	37,5 - 50 mm	13	25	1200
E250050075	SE 2 con testa autolivellante Ø 110 mm per travetto in alluminio <i>SE 2 with self-leveling head Ø 110 mm for aluminium joist</i>	50 - 75 mm	13	25	1200
E250075120	SE 3 con testa autolivellante Ø 110 mm per travetto in alluminio <i>SE 3 with self-leveling head Ø 110 mm for aluminium joist</i>	75 - 120 mm	13	25	800
E250120170	SE 4 con testa autolivellante Ø 110 mm per travetto in alluminio <i>SE 4 with self-leveling head Ø 110 mm for aluminium joist</i>	120 - 170 mm	13	25	600
E250170215	SE 5 con testa autolivellante Ø 110 mm per travetto in alluminio <i>SE 5 with self-leveling head Ø 110 mm for aluminium joist</i>	170 - 215 mm	13	25	600
E250140230	SE 6 con testa autolivellante Ø 110 mm per travetto in alluminio <i>SE 6 with self-leveling head Ø 110 mm for aluminium joist</i>	140 - 230 mm	13	-	-
E250185275	SE 7 con testa autolivellante Ø 110 mm per travetto in alluminio <i>SE 7 with self-leveling head Ø 110 mm for aluminium joist</i>	185 - 275 mm	13	-	-
E250235325	SE 8 con testa autolivellante Ø 110 mm per travetto in alluminio <i>SE 8 with self-leveling head Ø 110 mm for aluminium joist</i>	235 - 325 mm	13	-	-
E250205345	SE 9 con testa autolivellante Ø 110 mm per travetto in alluminio <i>SE 9 with self-leveling head Ø 110 mm for aluminium joist</i>	205 - 345 mm	13	-	-
E250250385	SE 10 con testa autolivellante Ø 110 mm per travetto in alluminio <i>SE 10 with self-leveling head Ø 110 mm for aluminium joist</i>	250 - 385 mm	13	-	-
E250300400	SE 11 con testa autolivellante Ø 110 mm per travetto in alluminio <i>SE 11 with self-leveling head Ø 110 mm for aluminium joist</i>	300 - 400 mm	13	-	-
E250270455	SE 12 con testa autolivellante Ø 110 mm per travetto in alluminio <i>SE 12 with self-leveling head Ø 110 mm for aluminium joist</i>	270 - 455 mm	13	-	-
E250315500	SE 13 con testa autolivellante Ø 110 mm per travetto in alluminio <i>SE 13 with self-leveling head Ø 110 mm for aluminium joist</i>	315 - 500 mm	13	-	-
E250365550	SE 14 con testa autolivellante Ø 110 mm per travetto in alluminio <i>SE 14 with self-leveling head Ø 110 mm for aluminium joist</i>	365 - 550 mm	13	-	-
E130125000	Prolunga P1* <i>P1 Extension*</i>	-	13	25	1050

*Prolunga utilizzabile solo con supporti SE3, SE4 e SE5.

*Extension element suitable only to types SE3, SE4 and SE5.



Dettaglio: aletta preincisa
Detail: pre-cut flap

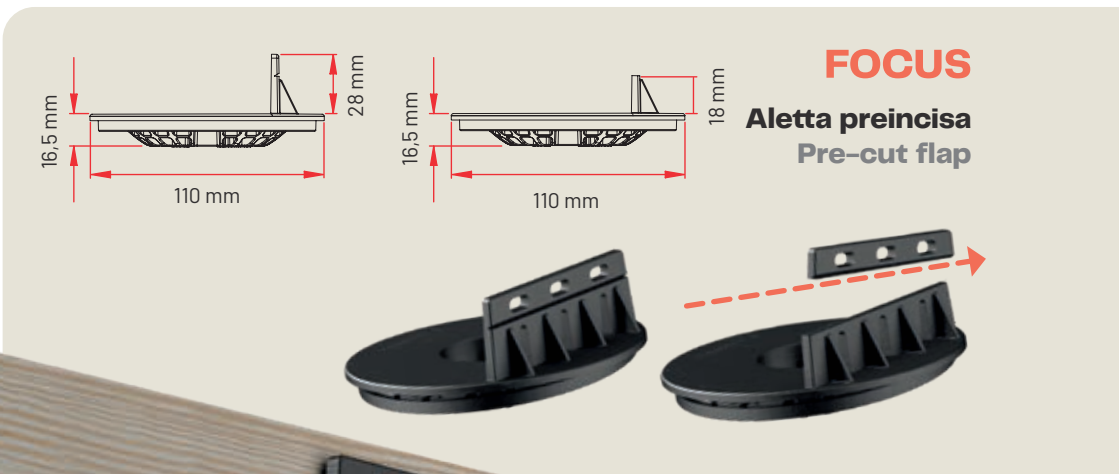



Dettaglio testa avvitata
su travetto in legno
Detail head screwed onto wooden joist

Supporto Eterno per travetto in legno

Eterno support for decking



CODICE CODE	DESCRIZIONE DESCRIPTION	MISURA SIZE	PAG. LISTINO PRICE LIST PAGE	PZ 	PZ 
E310028038	SE 0 con testa autolivellante Ø 110 mm per travetto in legno <i>SE 0 with self-leveling head Ø 110 mm for decking</i>	28 - 38 mm	14	25	1500
E310037050	SE 1 con testa autolivellante Ø 110 mm per travetto in legno <i>SE 1 with self-leveling head Ø 110 mm for decking</i>	37,5 - 50 mm	14	25	1200
E310050075	SE 2 con testa autolivellante Ø 110 mm per travetto in legno <i>SE 2 with self-leveling head Ø 110 mm for decking</i>	50 - 75 mm	14	25	1200
E310075120	SE 3 con testa autolivellante Ø 110 mm per travetto in legno <i>SE 3 with self-leveling head Ø 110 mm for decking</i>	75 - 120 mm	14	25	800
E310120170	SE 4 con testa autolivellante Ø 110 mm per travetto in legno <i>SE 4 with self-leveling head Ø 110 mm for decking</i>	120 - 170 mm	14	25	600
E310170215	SE 5 con testa autolivellante Ø 110 mm per travetto in legno <i>SE 5 with self-leveling head Ø 110 mm for decking</i>	170 - 215 mm	14	25	600
E310140230	SE 6 con testa autolivellante Ø 110 mm per travetto in legno <i>SE 6 with self-leveling head Ø 110 mm for decking</i>	140 - 230 mm	14	-	-
E310185275	SE 7 con testa autolivellante Ø 110 mm per travetto in legno <i>SE 7 with self-leveling head Ø 110 mm for decking</i>	185 - 275 mm	14	-	-
E310235325	SE 8 con testa autolivellante Ø 110 mm per travetto in legno <i>SE 8 with self-leveling head Ø 110 mm for decking</i>	235 - 325 mm	14	-	-
E310205345	SE 9 con testa autolivellante Ø 110 mm per travetto in legno <i>SE 9 with self-leveling head Ø 110 mm for decking</i>	205 - 345 mm	14	-	-
E310250385	SE 10 con testa autolivellante Ø 110 mm per travetto in legno <i>SE 10 with self-leveling head Ø 110 mm for decking</i>	250 - 385 mm	14	-	-
E310300400	SE 11 con testa autolivellante Ø 110 mm per travetto in legno <i>SE 11 with self-leveling head Ø 110 mm for decking</i>	300 - 400 mm	14	-	-
E310270455	SE 12 con testa autolivellante Ø 110 mm per travetto in legno <i>SE 12 with self-leveling head Ø 110 mm for decking</i>	270 - 455 mm	14	-	-
E310315500	SE 13 con testa autolivellante Ø 110 mm per travetto in legno <i>SE 13 with self-leveling head Ø 110 mm for decking</i>	315 - 500 mm	14	-	-
E310365550	SE 14 con testa autolivellante Ø 110 mm per travetto in legno <i>SE 14 with self-leveling head Ø 110 mm for decking</i>	365 - 550 mm	14	-	-
E130125000	Prolunga P1* <i>P1 Extension*</i>	-	14	25	1050
Q193000203	Vite a croce per legno <i>Screw for wood</i>	Ø 3,5 mm L 20 mm	14	1000	-

*Prolunga utilizzabile solo con supporti SE3, SE4 e SE5.

*Extension element suitable only to types SE3, SE4 and SE5.

Dettaglio del blocco automatico della rotazione

Detail of automatic lock of the rotation



Con travetto di alluminio

With aluminium joist

- 1 Gomma antirumore e antiscivolo
Non-slip and anti-noise rubber
- 2 Fermi per il blocco automatico della rotazione
Stops for the automatic locking of the rotation

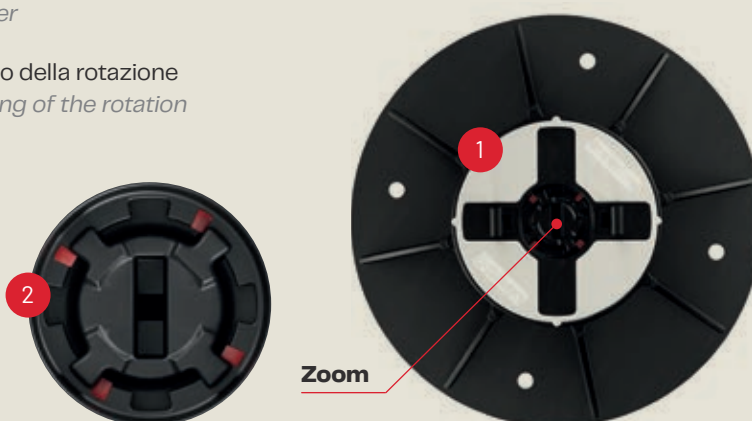

Con travetto di legno

With wooden joist

- 1 Fermi per il blocco automatico della rotazione
Stops for the automatic locking of the rotation

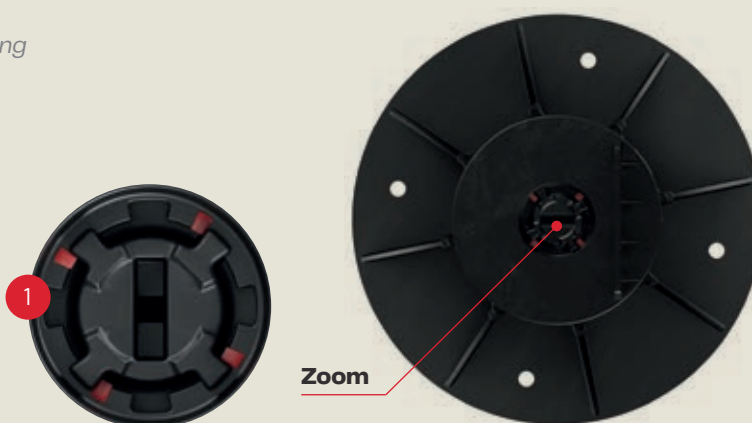

Supporto Eterno (Base + Vite)

Eterno support (Base + Screw)

TESTA ESCLUSA**HEAD EXCLUDED**

CODICE BASE + VITE CODE BASE + SCREW	DESCRIZIONE DESCRIPTION	MISURA SIZE	PAG. LISTINO PRICE LIST PAGE	PZ 	PZ 
E191028038	SE 0 base + vite <i>SE 0 base + screw</i> (B0 + V0)	28-38 mm*	15	25	1500
E191037050	SE 1 base + vite <i>SE 1 base + screw</i> (B1 + V1)	37,5-50 mm*	15	25	1200
E191050075	SE 2 base + vite <i>SE 2 base + screw</i> (B2 + V2)	50-75 mm*	15	25	1200
E191075120	SE 3 base + vite <i>SE 3 base + screw</i> (B3 + V3)	75-120 mm*	15	25	800
E191120170	SE 4 base + vite <i>SE 4 base + screw</i> (B3 + V4)	120-170 mm*	15	25	600
E191170215	SE 5 base + vite <i>SE 5 base + screw</i> (B3 + V5)	170-215 mm*	15	25	600
E191140230	SE 6 base + vite <i>SE 6 base + screw</i> (B3 + V3 + 1 P1)	140 - 230 mm*	15	-	-
E191185275	SE 7 base + vite <i>SE 7 base + screw</i> (B3 + V4 + 1 P1)	185 - 275 mm*	15	-	-
E191235325	SE 8 base + vite <i>SE 8 base + screw</i> (B3 + V5 + 1 P1)	235 - 325 mm*	15	-	-
E191205345	SE 9 base + vite <i>SE 9 base + screw</i> (B3 + V3 + 2 P1)	205 - 345 mm*	15	-	-
E191250385	SE 10 base + vite <i>SE 10 base + screw</i> (B3 + V4 + 2 P1)	250 - 385 mm*	15	-	-
E191300400	SE 11 base + vite <i>SE 11 base + screw</i> (B3 + V5 + 2 P1)	300 - 400 mm*	15	-	-
E191270455	SE 12 base + vite <i>SE 12 base + screw</i> (B3 + V3 + 3 P1)	270 - 455 mm*	15	-	-
E191315500	SE 13 base + vite <i>SE 13 base + screw</i> (B3 + V4 + 3 P1)	315 - 500 mm*	15	-	-
E191365550	SE 14 base + vite <i>SE 14 base + screw</i> (B3 + V5 + 3 P1)	365 - 550 mm*	15	-	-
E035101204	Testa bicomponente autolivellante, aletta 4 mm H 12 mm <i>Two-component self-leveling head, 4 mm tab H 12 mm</i>	Ø 110 mm	15	200	6400
E035100010	Testa bicomponente autolivellante per travetto alluminio <i>Two-component self-leveling head for aluminium joist</i>	Ø 110 mm	15	200	6400
E035102530	Testa autolivellante per travetto in legno <i>Self-leveling head for decking</i>	Ø 110 mm	15	100	4200
E035201204	Testa XL bicomponente autolivellante, aletta 4 mm H 12 mm <i>Two-component self-leveling XL head, 4 mm tab H 12 mm</i>	Ø 150 mm	15	100	3200
E035203001	Testa bicomponente autolivellante a incrocio per travetto alluminio <i>Two-component self-leveling Criss-cross head for aluminium joist</i>	Ø 130 mm	15	150	4800
E130125000	Prolunga P1** <i>P1 Extension**</i>	-	15	25	1050
E036000100	Blocco testa basculante <i>Locking system</i>	-	15	800***	-

Testa alette 2-3 mm o testa liscia a richiesta.

I codici dei supporti comprendono base e vite, senza testa.

* Le misure indicate si riferiscono a Base + Vite + Testa
Ø 110 mm autolivellante bicomponente.

** Prolunga utilizzabile solo con supporti SE3, SE4 e SE5.

*** In sacchetti da 100 pz.

Tab head 2-3 mm or plane head upon request.

The codes for the supports include the base and screw, without the head.

* The measurements indicated refer to Base + Screw + Self-leveling two-component head Ø 110 mm.

** Extension element suitable only to types SE3, SE4 and SE5.

*** Bags of 100 pcs.

NM

Supporto New Maxi

New Maxi support



NM

Supporto regolabile New Maxi

New Maxi adjustable support



Base con rottura facilitata
per una posa più rapida
*Base with easy-break for faster
installation*



330 cm²

Base di appoggio liscia di 330 cm²
Smooth support base of 330 cm²



Alette facilmente asportabili
Easily removable tabs

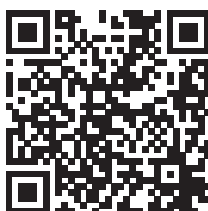

**Guarda il video
di presentazione**

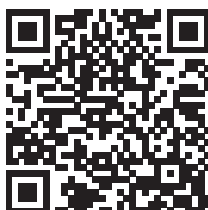

**Watch the
presentation video**

Sono tante le caratteristiche che lo hanno reso la scelta perfetta per la sopraelevazione: la testa in gomma anti rumore, la chiave di regolazione, le altezze variabili, la base a rottura facilitata per una posa più rapida.

Con un carico di rottura sopra la media del mercato e la sicura affidabilità degli specialisti dei supporti per pavimentazioni sopraelevate, è la scelta apprezzata e utilizzata negli edifici e nei cantieri di tutto il mondo.

La regolazione della pendenza avviene tramite gli appositi Compensatori di pendenza Twist TW.

There are numerous features that have made it the perfect choice for raised flooring: the anti-noise rubber head, the adjustment key, the variable heights, and the easy-break base for a faster installation.

Featuring an above average tensile strength and a reliability that can only be offered by experts in the field of raised flooring supports, this product is regularly selected and widely appreciated throughout the building industry worldwide.

The adjustment of the slope takes place via the appropriate Twist slope compensators.



Supporto con portata certificata
Tested for loading bearing capacity

NM**Vantaggi
Advantages**

- Testa con parte superiore in gomma antirumore e antiscivolo
 - Alette facilmente asportabili
 - Regolazione millimetrica da 15 mm
 - Regolazione dell'altezza, anche a pavimento finito, grazie all'esclusiva chiave di regolazione
 - Base di appoggio con rottura facilitata liscia di 330 cm²
 - Utilizzo Compensatore di pendenza Twist TW 110
 - Resistente a temperature da -40°C a +80°C
 - Resistente agli agenti atmosferici, agli acidi, all'invecchiamento, ai raggi UV
 - Utilizzabile con qualsiasi pavimentazione da esterno autoportante
 - Totalmente riciclabile
 - Test di carico a rottura certificati
- *Head with upper part in noise-reducing anti-slip rubber*
 - *Easily removable tabs*
 - *Precision adjustment from 15 mm*
 - *Possibility of adjusting the height once the floor has been finished, thanks to the exclusive adjustment key*
 - *330 cm² easy track and smooth basis*
 - *Utilization of Twist slope compensator TW 110*
 - *Resistant to temperatures ranging from -40°C to +80°C*
 - *Resistant to weathering, acids, UV rays and wear and tear*
 - *Can be used in conjunction with any outdoor flooring*
 - *Entirely recyclable*
 - *Test of tensile strength certified*

NM

Descrizione componenti Components description

**FOCUS**

Base di appoggio con rottura facilitata
Easy-break base



NM

Teste compatibili

Compatible heads

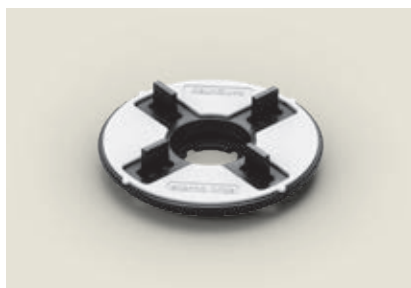

Testa fissa Ø 110 mm aletta 4 mm H 12 mm

Testa per la posa delle lastre direttamente su supporto o con griglia. Su richiesta spessore alette 2 o 3 mm.

Fixed head Ø 110 mm tab 4 mm H 12 mm

The head is designed for laying slabs directly on the support or with a grid system. On request, the tabs can be customized with a thickness of 2 or 3 mm.



Testa fissa Ø 110 mm per travetto in alluminio

L'aggancio con le sue specifiche alette, permette di accogliere il travetto senza necessità di ulteriori fissaggi.

Fixed head Ø 110 mm for aluminium joist

The attachment with its specific tabs allows the joist to be accommodated without the need for additional fixings.

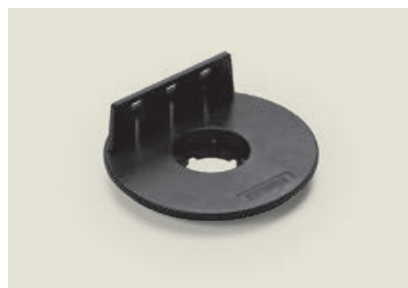

Testa fissa Ø 110 mm per travetto in legno

L'aletta laterale permette di accogliere con la massima semplicità di fissaggio e rapidità di installazione tutte le tipologie di sottostrutture.

Fixed head Ø 110 mm for decking

The lateral flap allows for the easiest and fastest installation of all types of substructures, ensuring maximum simplicity in the attachment process.

CODICE CODE	DESCRIZIONE DESCRIPTION	MISURA SIZE	PAG. LISTINO PRICE LIST PAGE	PZ 	PZ 
E035011204	Testa fissa bicomponente, aletta 4 mm H 12 mm <i>Two-component fixed head, 4 mm tab H 12 mm</i>	Ø 110 mm	19	200	6400
E034000010	Testa bicomponente fissa per travetto in alluminio <i>Two-component fixed head for aluminium joist</i>	Ø 110 mm	19	200	6400
E034000030	Testa fissa per travetto in legno <i>Fixed head for decking</i>	Ø 110 mm	19	150	6300

NM

Teste compatibili

Compatible heads



Testa fissa XL Ø 150 mm aletta 4 mm H 12 mm

Con il diametro di 150 mm offre una superficie d'appoggio superiore allo standard.

Su richiesta spessore alette 2 o 3 mm.

Fixed XL head Ø 150 mm tab 4 mm H 12 mm

With a diameter of 150 mm, it provides a larger support surface compared to the standard size. On request, tabs thickness can be 2 or 3 mm.



Testa fissa Ø 130 mm ad incrocio per travetti in alluminio

Può essere utilizzata in sostituzione della classica testa per travetto in alluminio per l'appoggio fino a 4 travetti contemporaneamente.

Fixed Criss-cross head Ø 130 mm for aluminium joist

It can be used as a replacement for the classic head for aluminum joists, allowing support for up to 4 joists simultaneously.

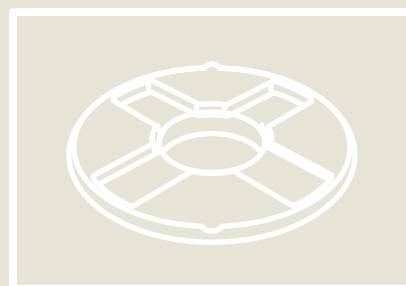

Teste speciali per utilizzi particolari

Sono disponibili teste speciali per l'aggancio anti-vento delle lastre o autoestinguenti.

Special heads for specific uses/applications

Special heads are available for the windproof attachment of the slabs or self-extinguishing purposes.



CODICE CODE	DESCRIZIONE DESCRIPTION	MISURA SIZE	PAG. LISTINO PRICE LIST PAGE	PZ 	PZ 
E035061204	Testa fissa XL bicomponente aletta 4 mm H 12 mm <i>XL two-component fixed head tabs 4 mm H 12 mm</i>	Ø 150 mm	19	100	3200
E035093001	Testa bicomponente fissa a incrocio per travetto in alluminio <i>Criss-cross two-component fixed head for aluminium joist</i>	Ø 130 mm	19	150	4800

Tabella composizione supporto NM + prolunga PNM
Table support composition NM + extension PNM

SUPPORTO SUPPORT	ALTEZZA HEIGHT		ALTEZZA HEIGHT + 1 PNM		ALTEZZA HEIGHT + 2 PNM		ALTEZZA HEIGHT + 3 PNM	
	min.	max.	min.	max.	min.	max.	min.	max.
NM 0	15	25	-	-	-	-	-	-
NM 1	25	40	-	-	-	-	-	-
NM 2	40	70	-	-	-	-	-	-
NM 3	60	100	-	-	275	395	380	540
NM 4	90	160	195	305	305	450	410	590
NM 5	150	270	300	415	410	555	520	700

Per una più sicura ripartizione del carico sul supporto consigliamo di non impiegare i filetti oltre il blocco posto sulla vite.

For a better distribution of loading, we recommend not to use the threads beyond the block placed on the screw.



NM 3 + 2 PNM
275-395 mm



NM 3 + 3 PNM
380-540 mm



NM 4 + 1 PNM
195-305 mm



NM 4 + 2 PNM
305-450 mm



NM 4 + 3 PNM
410-590 mm



NM 5 + 1 PNM
300-415 mm





NM 5 + 2 PNM
410-555 mm



NM 5 + 3 PNM
520-700 mm

Supporto NM New Maxi per posa lastre
direttamente sui supporti o su griglia
NM New Maxi support for laying slabs directly
on supports or on a grid



CODICE CODE	DESCRIZIONE DESCRIPTION	MISURA SIZE	PAG. LISTINO PRICE LIST PAGE	PZ 	PZ 
E014015027	NM 0 con testa fissa Ø 110 mm, aletta 4 mm H 12 mm <i>NM 0 with fixed head Ø 110 mm, tab 4 mm H 12 mm</i>	15-25 mm	16	20	1680
E014025047	NM 1 con testa fissa Ø 110 mm, aletta 4 mm H 12 mm <i>NM 1 with fixed head Ø 110 mm, tab 4 mm H 12 mm</i>	25-40 mm	16	20	1320
E014040077	NM 2 con testa fissa Ø 110 mm, aletta 4 mm H 12 mm <i>NM 2 with fixed head Ø 110 mm, tab 4 mm H 12 mm</i>	40-70 mm	16	20	960
E014060107	NM 3 con testa fissa Ø 110 mm, aletta 4 mm H 12 mm <i>NM 3 with fixed head Ø 110 mm, tab 4 mm H 12 mm</i>	60-100 mm	16	20	720
E014090167	NM 4 con testa fissa Ø 110 mm, aletta 4 mm H 12 mm <i>NM 4 with fixed head Ø 110 mm, tab 4 mm H 12 mm</i>	90-160 mm	16	20	600
E014150277	NM 5 con testa fissa Ø 110 mm, aletta 4 mm H 12 mm <i>NM 5 with fixed head Ø 110 mm, tab 4 mm H 12 mm</i>	150-270 mm	16	20	420
E044000145	Prolunga PNM* <i>PNM Extension*</i>	-	16	30	600

Testa alette 2-3 mm o testa liscia a richiesta.

* Prolunga utilizzabile solo con supporti NM3, NM4 e NM5.

Tab head 2-3 mm or plane head upon request.

* Extension can only be used with NM3, NM4 and NM5 supports.



NM 0

15-25 mm

NM 1

25-40 mm

NM 2

40-70 mm

NM 3

60-100 mm

NM 4

90-160 mm

NM 5

150-270 mm

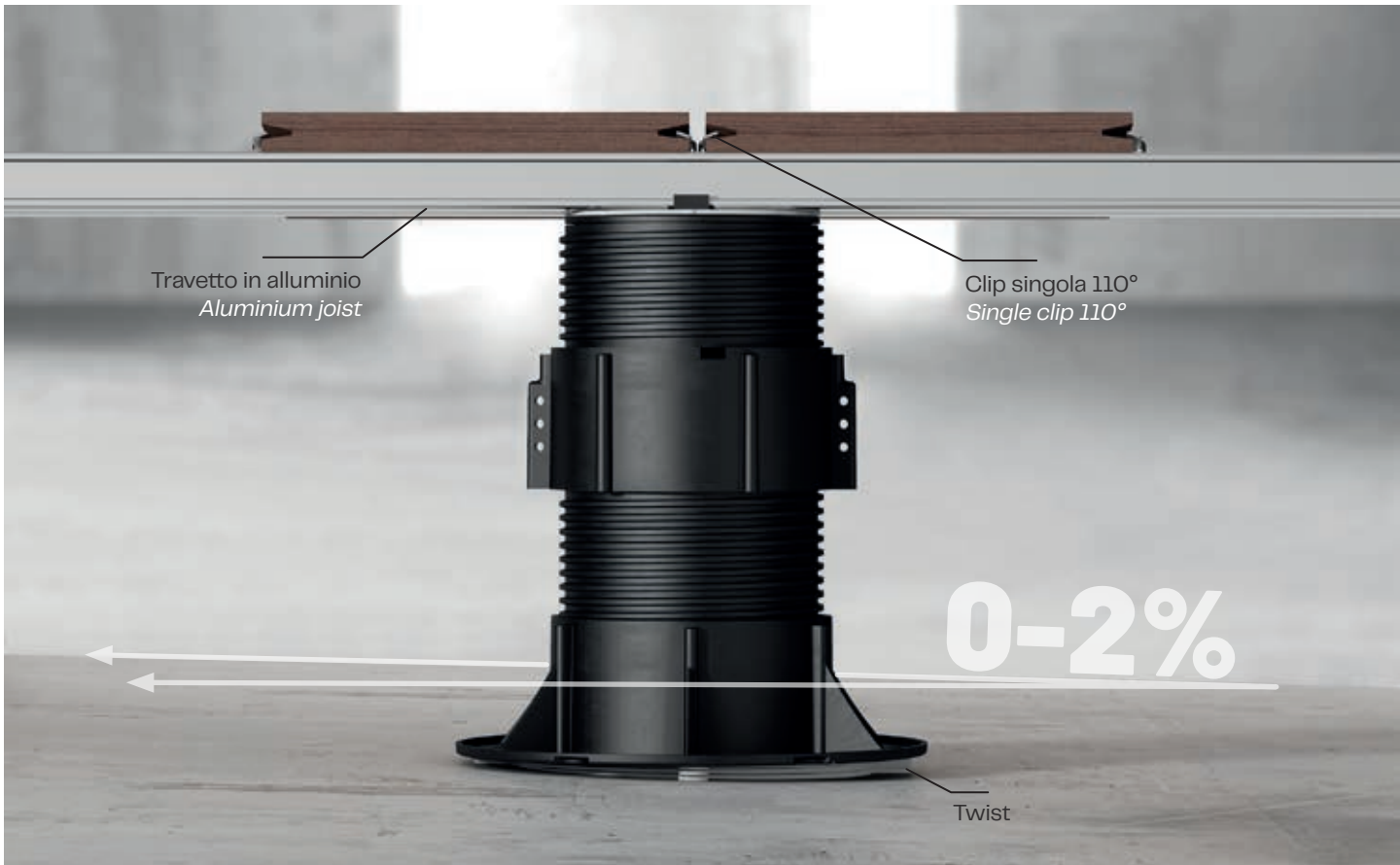

Supporto NM New Maxi per travetto in alluminio

NM New Maxi Support for aluminium joist



CODICE CODE	DESCRIZIONE DESCRIPTION	MISURA SIZE	PAG. LISTINO PRICE LIST PAGE	PZ 	PZ
E014015025	NM 0 con testa fissa Ø 110 mm per travetto in alluminio <i>NM 0 with fixed head Ø 110 mm for aluminium joist</i>	15-25 mm	17	20	1680
E014025045	NM 1 con testa fissa Ø 110 mm per travetto in alluminio <i>NM 1 with fixed head Ø 110 mm for aluminium joist</i>	25-40 mm	17	20	1320
E014040075	NM 2 con testa fissa Ø 110 mm per travetto in alluminio <i>NM 2 with fixed head Ø 110 mm for aluminium joist</i>	40-70 mm	17	20	960
E014060105	NM 3 con testa fissa Ø 110 mm per travetto in alluminio <i>NM 3 with fixed head Ø 110 mm for aluminium joist</i>	60-100 mm	17	20	720
E014090165	NM 4 con testa fissa Ø 110 mm per travetto in alluminio <i>NM 4 with fixed head Ø 110 mm for aluminium joist</i>	90-160 mm	17	20	600
E014150275	NM 5 con testa fissa Ø 110 mm per travetto in alluminio <i>NM 5 with fixed head Ø 110 mm for aluminium joist</i>	150-270 mm	17	20	420
E044000145	Prolunga PNM* <i>PNM Extension*</i>	-	17	30	600

* Prolunga utilizzabile solo con supporti NM3, NM4 e NM5.

* Extension can only be used with NM3, NM4 and NM5 supports.

Dettaglio del blocco automatico della rotazione

Detail of stops for the automatic locking of the rotation

- 1 Gomma antirumore e antiscivolamento
Non-slip and anti-noise rubber
- 2 Fermi per il blocco automatico della rotazione
Stops for the automatic locking of the rotation

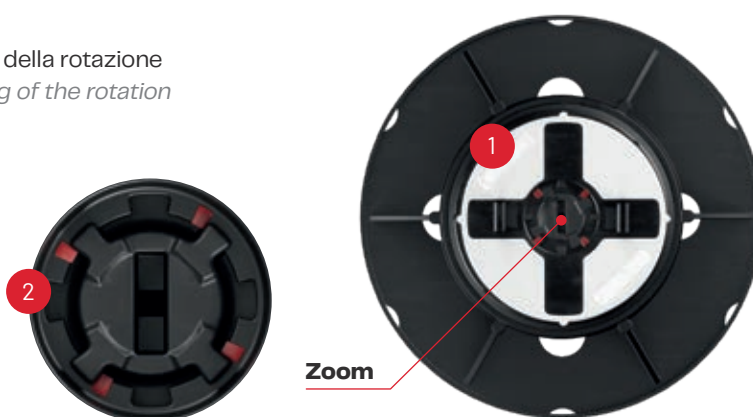

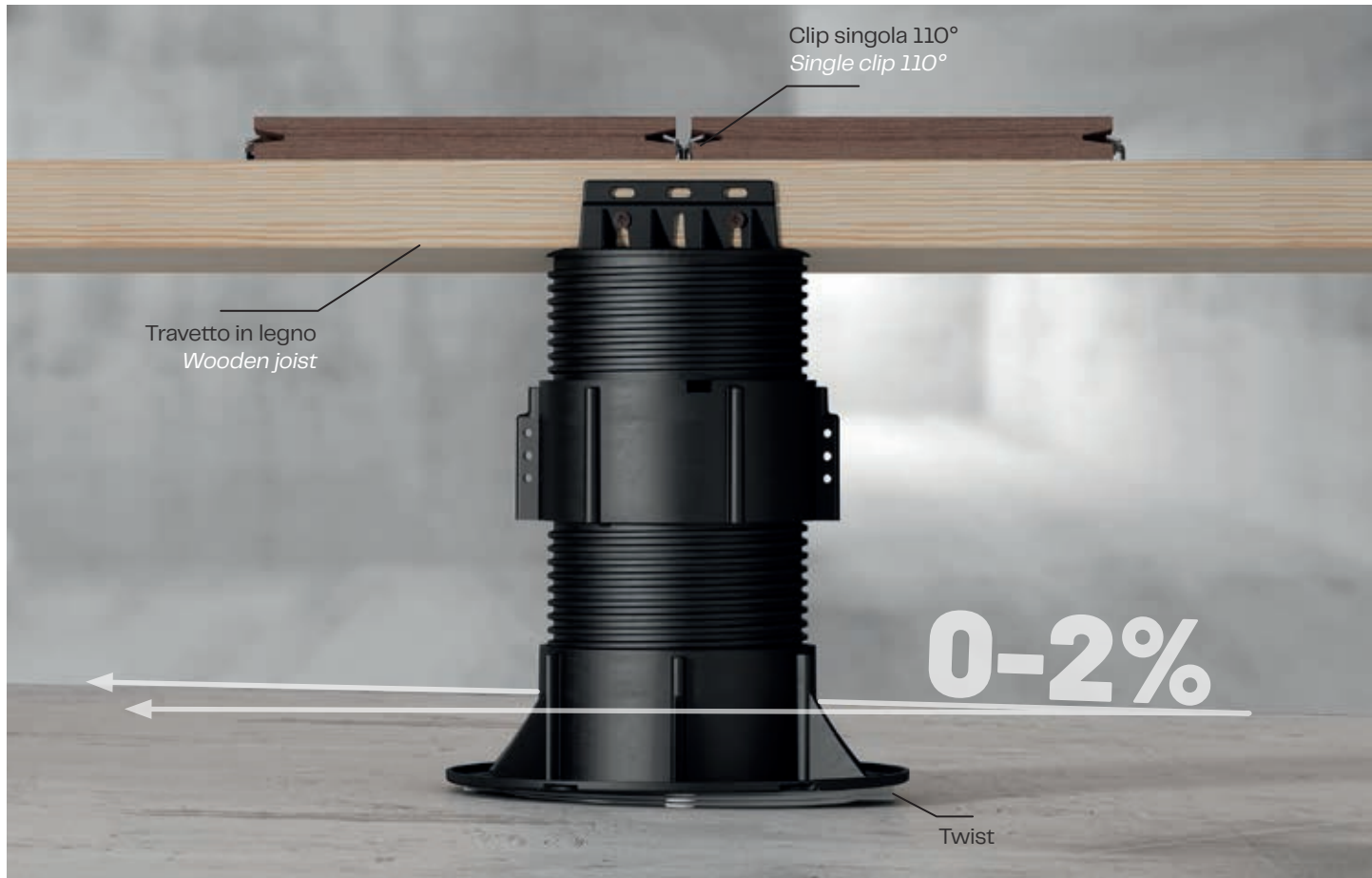

Dettaglio: aletta preincisa
Detail: pre-cut flap

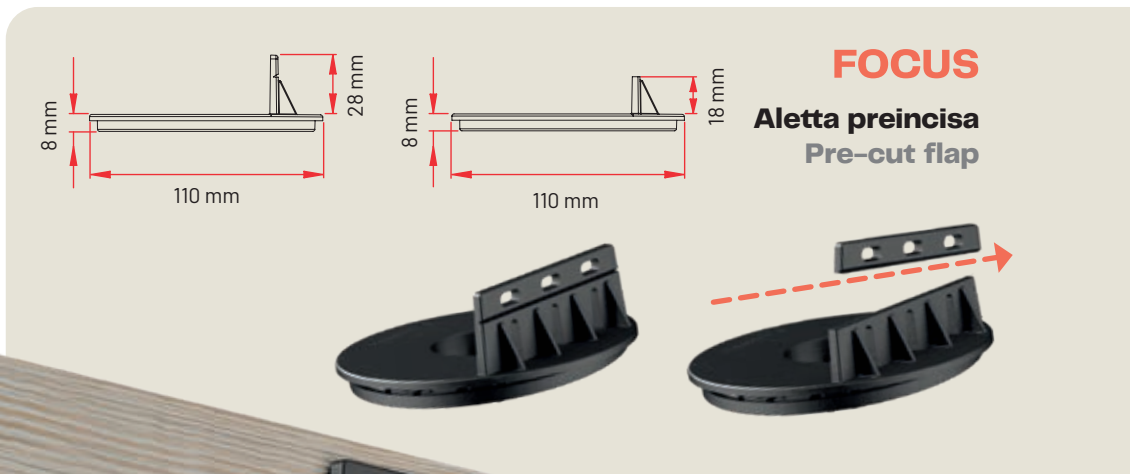

Dettaglio testa avvitata
su travetto in legno.
Detail head screwed onto
wooden joist.

Supporto NM New Maxi per travetto in legno

NM New Maxi support for decking



CODICE CODE	DESCRIZIONE DESCRIPTION	MISURA SIZE	PAG. LISTINO PRICE LIST PAGE	PZ 	PZ
E014015028	NM 0 con testa fissa Ø 110 mm per travetto in legno <i>NM 0 with fixed head Ø 110 mm for decking</i>	15-25 mm	18	20	1680
E014025048	NM 1 con testa fissa Ø 110 mm per travetto in legno <i>NM 1 with fixed head Ø 110 mm for decking</i>	25-40 mm	18	20	1320
E014040078	NM 2 con testa fissa Ø 110 mm per travetto in legno <i>NM 2 with fixed head Ø 110 mm for decking</i>	40-70 mm	18	20	960
E014060108	NM 3 con testa fissa Ø 110 mm per travetto in legno <i>NM 3 with fixed head Ø 110 mm for decking</i>	60-100 mm	18	20	720
E014090168	NM 4 con testa fissa Ø 110 mm per travetto in legno <i>NM 4 with fixed head Ø 110 mm for decking</i>	90-160 mm	18	20	600
E014150278	NM 5 con testa fissa Ø 110 mm per travetto in legno <i>NM 5 with fixed head Ø 110 mm for decking</i>	150-270 mm	18	20	420
E044000145	Prolunga PNM* <i>PNM Extension*</i>	-	18	30	600
Q193000203	Vite a croce per legno <i>Phillips Screw for wood</i>	Ø 3,5 mm L 20 mm	18	1000	-

* Prolunga utilizzabile solo con supporti NM3, NM4 e NM5.

* Extension can only be used with NM3, NM4 and NM5 supports.

Dettaglio del blocco automatico della rotazione

Detail of stops for the automatic locking of the rotation

- 1 Fermi per il blocco automatico della rotazione
Stops for the automatic locking of the rotation







Supporto New Maxi (Base + Vite)

New Maxi support (Base + Screw)

TESTA ESCLUSA**HEAD EXCLUDED**

CODICE BASE + VITE CODE BASE + SCREW	DESCRIZIONE DESCRIPTION	MISURA SIZE	PAG. LISTINO PRICE LIST PAGE	PZ 	PZ 
E045015025	NM 0 base + vite <i>NM 0 base + screw</i>	15-25 mm*	19	20	1680
E045025040	NM 1 base + vite <i>NM 1 base + screw</i>	25-40 mm*	19	20	1320
E045040070	NM 2 base + vite <i>NM 2 base + screw</i>	40-70 mm*	19	20	960
E045060100	NM 3 base + vite <i>NM 3 base + screw</i>	60-100 mm*	19	20	720
E045090160	NM 4 base + vite <i>NM 4 base + screw</i>	90-160 mm*	19	20	600
E045150270	NM 5 base + vite <i>NM 5 base + screw</i>	150-270 mm*	19	20	420
E035011204	Testa fissa bicomponente, aletta 4 mm H 12 mm <i>Two-component fixed head, 4 mm tab H 12 mm</i>	Ø 110 mm	19	200	6400
E034000010	Testa bicomponente fissa per travetto in alluminio <i>Two-component fixed head for aluminium joist</i>	Ø 110 mm	19	200	6400
E034000030	Testa fissa per travetto in legno <i>Fixed head for decking</i>	Ø 110 mm	19	150	6300
E035061204	Testa fissa XL bicomponente aletta 4 mm H 12 mm <i>XL two-component fixed head tabs 4 mm H 12 mm</i>	Ø 150 mm	19	100	3200
E035093001	Testa bicomponente fissa a incrocio per travetto in alluminio <i>Criss-cross two-component fixed head for aluminium joist</i>	Ø 130 mm	19	150	4800
E044000145	Prolunga PNM** <i>PNM Extension**</i>	-	19	30	600
Q193000203	Vite a croce per legno <i>Phillips Screw for wood</i>	Ø 3,5 mm L 20 mm	19	1000	-

Testa alette 2-3 mm o testa liscia a richiesta.

I codici dei supporti comprendono base e vite, senza testa.

* Le misure indicate si riferiscono a Base + Vite + Testa Ø 110 mm bicomponente.

** Prolunga utilizzabile solo con supporti NM3, NM4 e NM5.

Tab head 2-3 mm or plane head upon request.

The codes for the supports include the base and screw, without the head.

** The measurements indicated refer to Base + Screw + Two-component head Ø 110 mm.*

*** Extension can only be used with NM3, NM4 and NM5 supports.*



SB

Supporto Basic

Basic support



SB

Supporto regolabile Basic

Basic adjustable support

330 cm²

Base di appoggio liscia di 330 cm²
Smooth support base of 330 cm²



Base con deflusso acqua sicuro
 e garantito

*Base with safe and guaranteed
 water flow*



Compensatore di pendenza Twist
Utilization of Twist slope compensator



**Guarda il video
 di presentazione**



**Watch the
 presentation video**

Il più semplice della linea Pedestal, il supporto Basic sintetizza in maniera perfetta due elementi: tecnica e versatilità, in un mix essenziale che non dimentica però l'esigenza di rispondere alle prove di carico a rottura, nonché la possibilità di regolare millimetricamente l'altezza da 27 mm, a favore di un perfetto livellamento della pavimentazione.

La regolazione della pendenza avviene tramite gli appositi Compensatori di pendenza Twist TW 110.

The simplest of the Pedestal line, the Basic Support synthesizes perfectly two elements: technology and versatility, an essential mix that does not forget the need to support heavy tensile forces, and the possibility to adjust by the millimeter height's from 27 mm, in favor of a perfect leveling of the flooring.

The adjustment of the slope takes place via the appropriate Twist slope compensators.



Supporto con portata certificata
Tested for loading bearing capacity

SB**Vantaggi
Advantages**

- Regolazione millimetrica da 27 mm
- Regolazione dell'altezza agendo direttamente sulla base
- Base di appoggio liscia di 330 cm²
- Resistente agli agenti atmosferici, agli acidi, all'invecchiamento, ai raggi UV.
- Resistente a temperature fra -40°C e +80°C
- Totalmente riciclabile
- Utilizzabile con qualsiasi pavimentazione autoportante da esterno
- Test di carico a rottura certificati
- Utilizzo Compensatore di pendenza Twist TW 110

- *Accurate adjustment from 27 mm*
- *Possibility of adjusting the height by acting directly on the base*
- *Smooth base of 330 cm²*
- *Resistant to weathering, acids, UV rays and wear and tear.*
- *Resistant to temperatures ranging from -40°C to +80°C*
- *Fully recyclable*
- *Can be used in conjunction with any outdoor flooring*
- *Test of tensile strength certified*
- *Utilization of Twist slope compensator TW 110*

SB

Descrizione componenti Components description

Testa/vite con alette standard
spessore 4 mm, H 12 mm
*Head/screw with standard
4 mm thick tabs, H 12 mm*



Prolunga PSB
PSB Extension

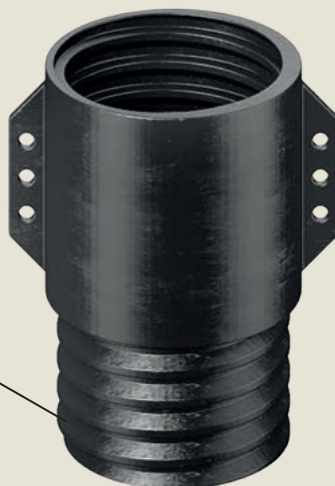

Fori scarico acqua
Water drainage holes

Base di appoggio
Supporting base



Tabella composizione SB 1 – SB 8

Composition table SB 1 – SB 8

SUPPORTO SUPPORT	COMPOSIZIONE COMPOSITION
SB 1	SB 1
SB 2	SB 2
SB 3	SB 3
SB 4	SB 4
SB 5	SB 3 + 1 Prolunga PSB <i>SB 3 + 1 PSB extension</i>
SB 6	SB 4 + 1 Prolunga PSB <i>SB 4 + 1 PSB extension</i>
SB 7	SB 3 + 2 Prolunghe PSB <i>SB 3 + 2 PSB extensions</i>
SB 8	SB 4 + 2 Prolunghe PSB <i>SB 4 + 2 PSB extensions</i>

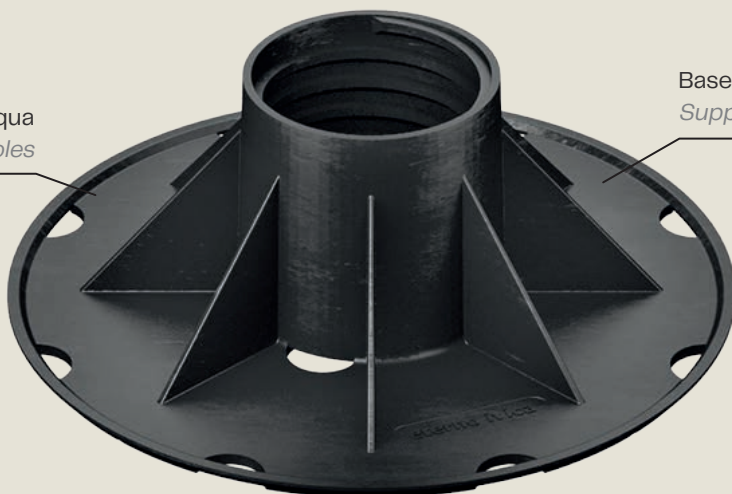

SB 1
27–35 mm



SB 2
35–50 mm



SB 3
50–80 mm





SB 4
70–120 mm

Supporto SB Basic per posa lastre direttamente sui supporti o su griglia

SB Basic support for laying slabs directly on supports or on a grid



CODICE CODE	DESCRIZIONE DESCRIPTION	MISURA SIZE	PAG. LISTINO PRICE LIST PAGE	PZ 	PZ 
E015427035	SB 1 con alette spessore 4 mm H 12 mm <i>SB 1 with tabs thickness 4 mm H 12 mm</i>	27-35 mm	20	40	1680
E015435050	SB 2 con alette spessore 4 mm H 12 mm <i>SB 2 with tabs thickness 4 mm H 12 mm</i>	35-50 mm	20	30	1260
E015450080	SB 3 con alette spessore 4 mm H 12 mm <i>SB 3 with tabs thickness 4 mm H 12 mm</i>	50-80 mm	20	35	1050
E015470120	SB 4 con alette spessore 4 mm H 12 mm <i>SB 4 with tabs thickness 4 mm H 12 mm</i>	70-120 mm	20	25	750
E015481117	SB 5 con alette spessore 4 mm H 12 mm <i>SB 5 with tabs thickness 4 mm H 12 mm</i>	112-168 mm	20	-	-
E015481320	SB 6 con alette spessore 4 mm H 12 mm <i>SB 6 with tabs thickness 4 mm H 12 mm</i>	132-210 mm	20	-	-
E015481726	SB 7 con alette spessore 4 mm H 12 mm <i>SB 7 with tabs thickness 4 mm H 12 mm</i>	175-260 mm	20	-	-
E015481929	SB 8 con alette spessore 4 mm H 12 mm <i>SB 8 with tabs thickness 4 mm H 12 mm</i>	195-300 mm	20	-	-
E044000625	Prolunga PSB* <i>PSB Extension*</i>	-	20	50	2100

Testa liscia a richiesta.

* Prolunga utilizzabile con supporti SB3 e SB4.

Plane head upon request.

* Extension element suitable only to types from SB3 to SB4.



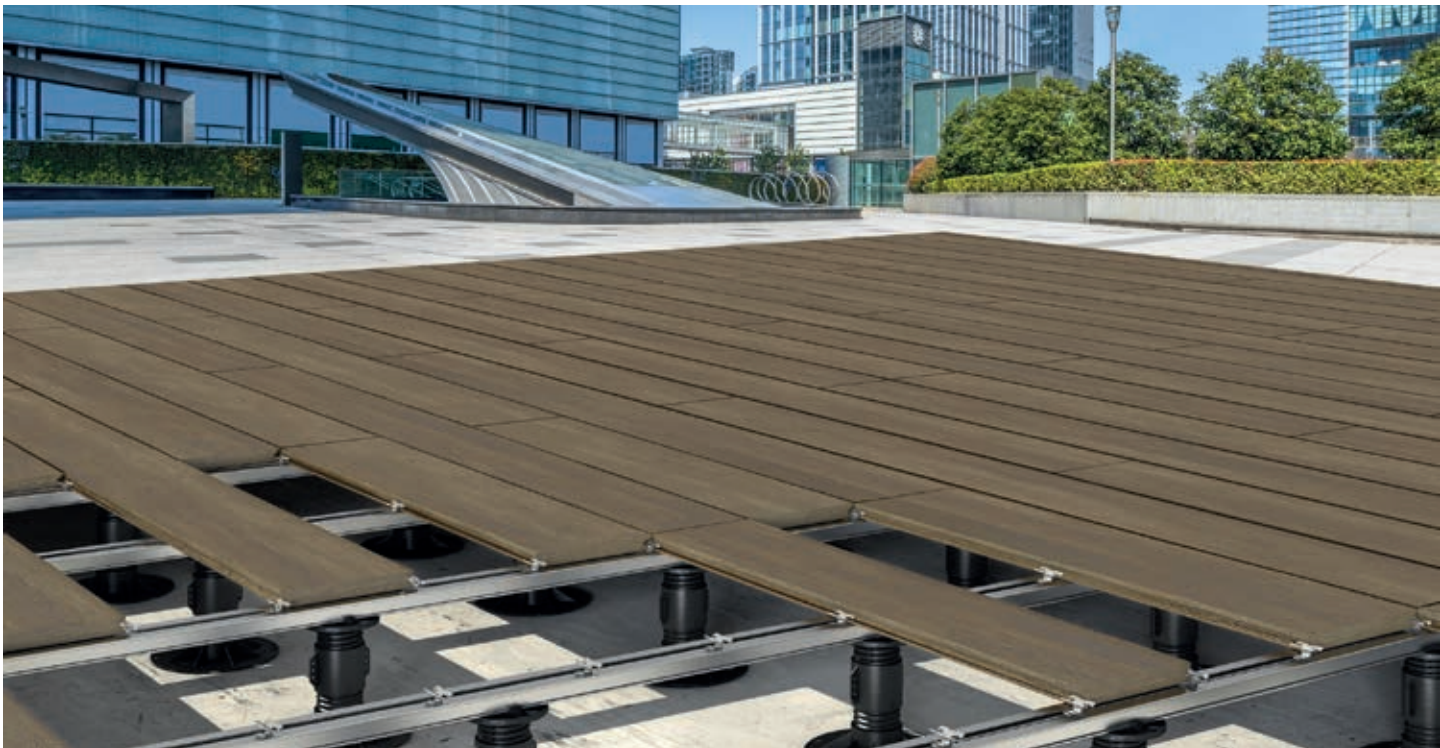
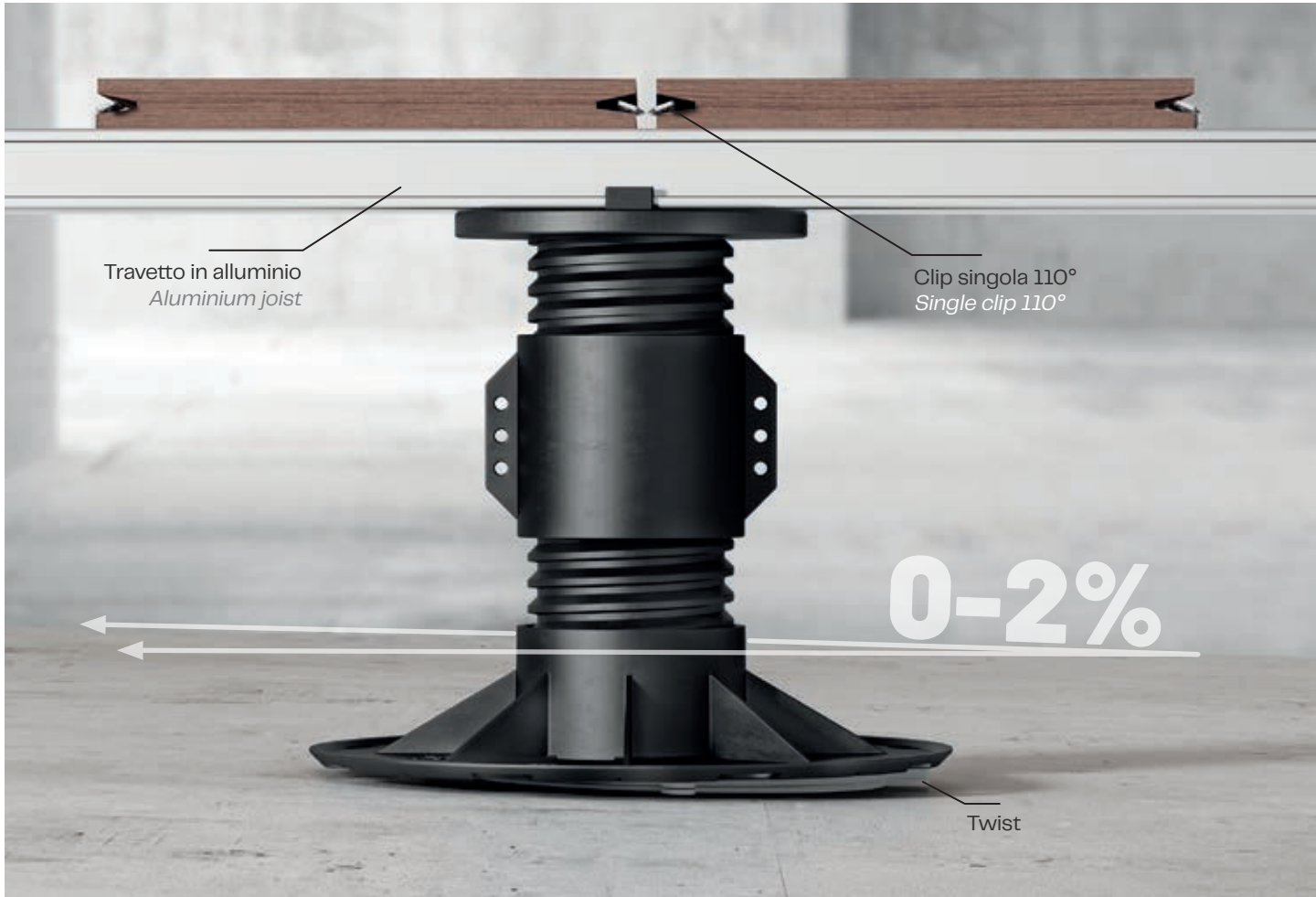



Supporto SB Basic per travetto in alluminio

SB Basic support for aluminium joist



CODICE CODE	DESCRIZIONE DESCRIPTION	MISURA SIZE	PAG. LISTINO PRICE LIST PAGE	PZ 	PZ 
E015727035	SB 1 per travetto in alluminio <i>SB 1 for aluminium joist</i>	27-35 mm	21	40	1680
E015735050	SB 2 per travetto in alluminio <i>SB 2 for aluminium joist</i>	35-50 mm	21	30	1260
E015750080	SB 3 per travetto in alluminio <i>SB 3 for aluminium joist</i>	50-80 mm	21	35	1050
E015770120	SB 4 per travetto in alluminio <i>SB 4 for aluminium joist</i>	70-120 mm	21	25	750
E015781117	SB 5 per travetto in alluminio <i>SB 5 for aluminium joist</i>	112-168 mm	21	-	-
E015781320	SB 6 per travetto in alluminio <i>SB 6 for aluminium joist</i>	132-210 mm	21	-	-
E015781726	SB 7 per travetto in alluminio <i>SB 7 for aluminium joist</i>	175-260 mm	21	-	-
E015781929	SB 8 per travetto in alluminio <i>SB 8 for aluminium joist</i>	195-300 mm	21	-	-
E044000625	Prolunga PSB* <i>PSB Extension*</i>	-	21	50	2100

* Prolunga utilizzabile solo con supporti SB3 e SB4.

* *Extension element suitable only to types SB3 and SB4.*







Supporto SB Basic per travetto in legno

SB Basic support for decking



CODICE CODE	DESCRIZIONE DESCRIPTION	MISURA SIZE	PAG. LISTINO PRICE LIST PAGE	PZ 	PZ 
E015627035	SB 1 con testa per travetto in legno <i>SB 1 with head for decking</i>	27-35 mm	22	40	1680
E015635050	SB 2 con testa per travetto in legno <i>SB 2 with head for decking</i>	35-50 mm	22	30	1260
E015650080	SB 3 con testa per travetto in legno <i>SB 3 with head for decking</i>	50-80 mm	22	35	1050
E015670120	SB 4 con testa per travetto in legno <i>SB 4 with head for decking</i>	70-120 mm	22	25	750
E015681117	SB 5 con testa per travetto in legno <i>SB 5 with head for decking</i>	112-168 mm	22	-	-
E015681320	SB 6 con testa per travetto in legno <i>SB 6 with head for decking</i>	132-210 mm	22	-	-
E015681726	SB 7 con testa per travetto in legno <i>SB 7 with head for decking</i>	175-260 mm	22	-	-
E015681929	SB 8 con testa per travetto in legno <i>SB 8 with head for decking</i>	195-300 mm	22	-	-
E044000625	Prolunga PSB* <i>PSB Extension*</i>	-	22	50	2100
Q193000203	Vite a croce per legno <i>Phillips Screw for wood</i>	Ø 3,5 mm L 20 mm	22	1000	-

* Prolunga utilizzabile solo con supporti SB 3 e SB 4.

* Extension element suitable only to types SB 3 and SB 4.

Dettaglio testa avvitata
su travetto in legno.
*Detail head screwed onto
wooden joist.*



ST

Supporto Star.T

Star.T support



ST

Supporto regolabile Star.T

Star.T adjustable support



10 mm

Regolazione millimetrica
a partire da 10 mm
*Millimeter adjustment starting
from 10 mm*



Alette facilmente asportabili
Easily removable tabs



Compensatore di pendenza
Twist
*Utilization of Twist slope
compensator*



**Guarda il video
di presentazione**



**Watch the
presentation video**



Un supporto per pavimentazioni esterne non è mai stato così sottile, si chiama Star.T e sarà destinato a rivoluzionare il mercato: il più adattabile e personalizzabile soprattutto per le ristrutturazioni, l'unico sempre regolabile grazie all'ormai famosa "chiave di regolazione", il solo capace di realizzare qualsiasi pavimento rendendo semplice ogni progetto outdoor, domestico o contract. Il supporto Star.T di Eterno Ivica è in grado di soddisfare le "soglie" più esigenti.

La regolazione della pendenza avviene tramite gli appositi Compensatori di pendenza Twist TW 150.

Outdoor flooring support has never been so thin – it is called Star.T and it is a market revolution. It is the most adaptable pedestal, especially for renovations. It makes any outdoor project simple, whether you're doing it by yourself or hiring contractors, and it is guaranteed by Eterno Ivica.

Eterno Ivica's Star.T support can meet even the most demanding "thresholds". The adjustment of the slope takes place via the appropriate Twist slope compensators produced by us.



Supporto con portata certificata
Tested for loading bearing capacity

ST**Vantaggi
Advantages**

- Il più basso regolabile al mondo!
- Alta tecnicità
- Alette facilmente asportabili
- Possibilità di sopraelevare 8 mm con uno dei due componenti + 5 mm aggiungendo Prolunga Star.T
- Regolazione millimetrica da 10 a 30 mm
- Chiave di regolazione
- Utilizzo di Compensatore di pendenza TW 150

- *The lowest adjustable in the world!*
- *High Technicality*
- *Easily removable tabs*
- *Minimal height 8 mm only if used with head component by itself + 5 mm with Star.T extension element*
- *Accurate adjustment from 10 to 30 mm*
- *Adjustment key*
- *Can be enhanced with Twist slope compensator TW 150*

ST

Descrizione componenti Components description

Grazie ai suoi ridotti ingombri è un ottimo alleato per le ristrutturazioni: Star.T è in grado di soddisfare i più bassi spessori grazie alla parte fissa che misura appena 8 mm, per poi diventare regolabile da 10 mm fino a 30 mm, sopraelevando qualsiasi tipo di pavimento in ceramica, cemento o materiale composito, di qualsiasi formato e peso.

La regolazione millimetrica di Star.T permette di ottenere pavimentazioni eleganti e perfettamente in bolla, accorciando così i tempi di posa e conferendo stabilità e precisione a tutta la pavimentazione.

La prolunga Star.T è l'unica adattabile allo Star.T, permette di raggiungere l'altezza dei supporti regolabili PR1, SR1, SRT1, SEO, NM1, SB1; un'unica altezza per un prodotto versatile e semplice: si posiziona sotto lo Star.T aumentando la sua altezza di 5 mm e multipli con la possibilità di sovrapporre più prolunghie in caso di necessità.

Thanks to its reduced dimensions it is a great ally for renovations: Star.T is able to satisfy the lowest thicknesses thanks to the fixed part measuring just 8 mm, and then become adjustable from 10 mm to 30 mm, by raising any type of ceramic floor, concrete or composite material of any size and weight.

The accurate adjustment of Star.T allows you to obtain elegant and perfectly levelled pavings, thus shortening the installation times and conferring stability and precision to the entire pavement.

Star.T extension is the only one compatible with Star.T, it allows you to reach the height of the adjustable supports PR1, SR1, SRT1, SEO, NM1, SB1; single height for a simple and versatile product: it is positioned under the Star.T increasing its height by multiples of 5 mm with the possibility of stacking more extensions in case of need.

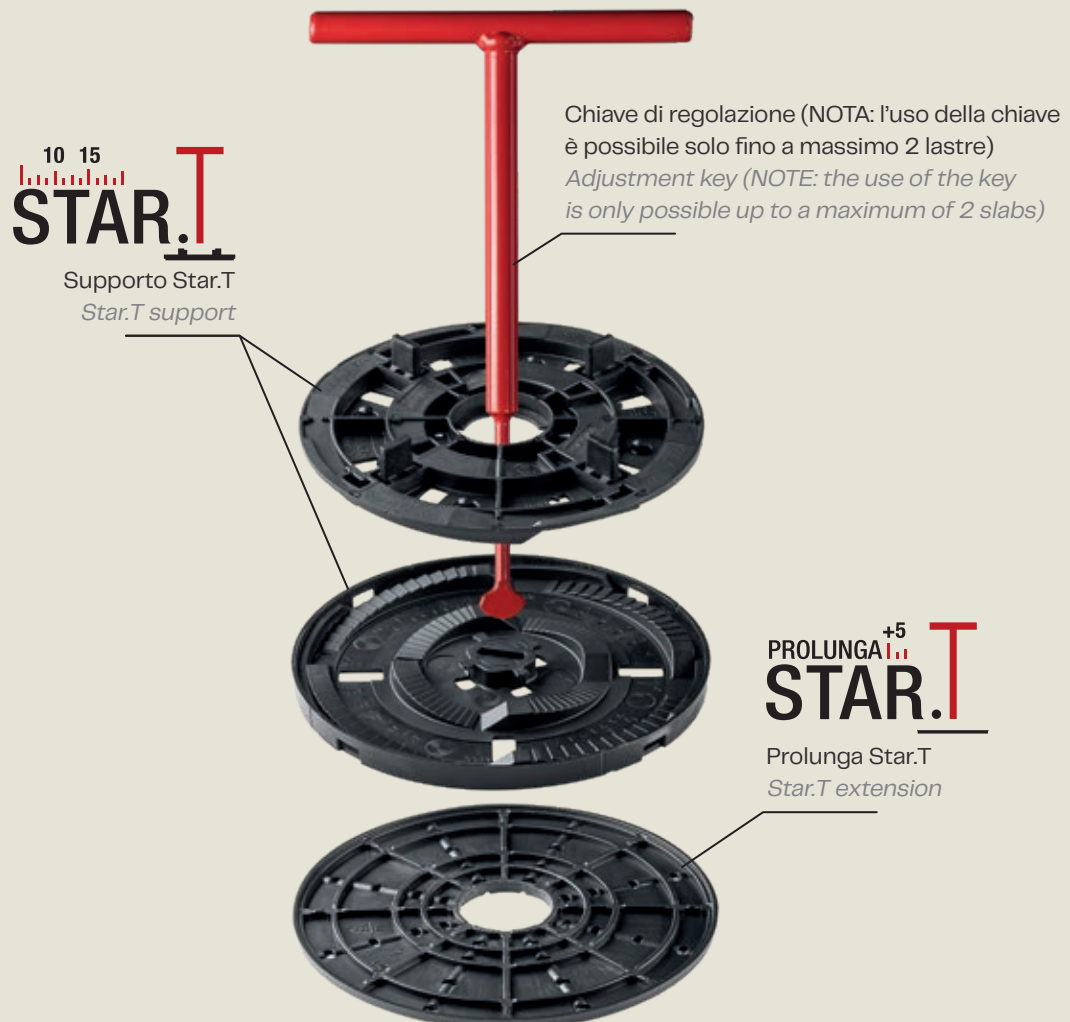



Supporto Star.T per posa lastre direttamente sui supporti o su griglia

Star.T support for laying slabs directly on supports or on a grid



Star.T può essere regolato in altezza in maniera millimetrica partendo dai 10 mm del suo spessore completo, fino a 15 mm ruotando la base inferiore del supporto. Può anche essere usato come supporto fisso di altezza 8 mm utilizzando la sola parte superiore del supporto.

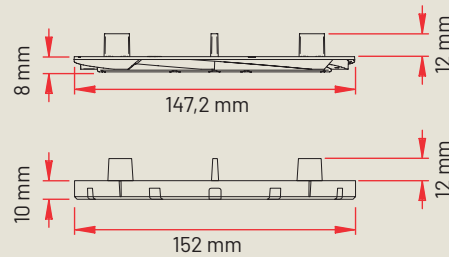



Star.T can be adjusted in height by the millimeter starting from 10 mm of its full thickness up to 15 mm by rotating the lower base of the support. It can be also used as a 8 mm high fixed support by using the upper part only.

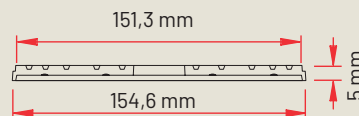

La Prolunga Star.T si posiziona sotto lo Star.T per incrementarne l'altezza di 5 mm, con la possibilità di sovrapporre ulteriori Prolunghe Star.T in caso di necessità. La Prolunga Star.T è l'unica adattabile allo Star.T, che permette di raggiungere l'altezza dei supporti regolabili PR1, SR1, SRT1, SEO, NM1, SB1.



The Star.T extension is positioned under the Star.T to increase the height of 5 mm, with the possibility of stacking additional Star.T extensions in case of need. Star.T extension is the only one adaptable to Star.T, allowing you to reach the height of the adjustable supports PR1, SR1, SRT1, SEO, NM1, SB1.

CODICE CODE	DESCRIZIONE DESCRIPTION	MISURA SIZE	PAG. LISTINO PRICE LIST PAGE	PZ KIT	PZ 	PZ 
E003541115	Star.T con testa aletta 4 mm H 12 mm <i>Star.T with tabs head 4 mm thick H 12 mm</i>	10-15 mm	24	20	100	5400
E003100025	Prolunga Star.T <i>Star.T extension</i>	5 mm	24	20	100	9600

Testa con aletta 2 - 3 mm o liscia, su richiesta.

Tab head 2-3 mm or plane head upon request.



Supporto Star.T per posa su travetto in alluminio Star.T support for laying on aluminium joist

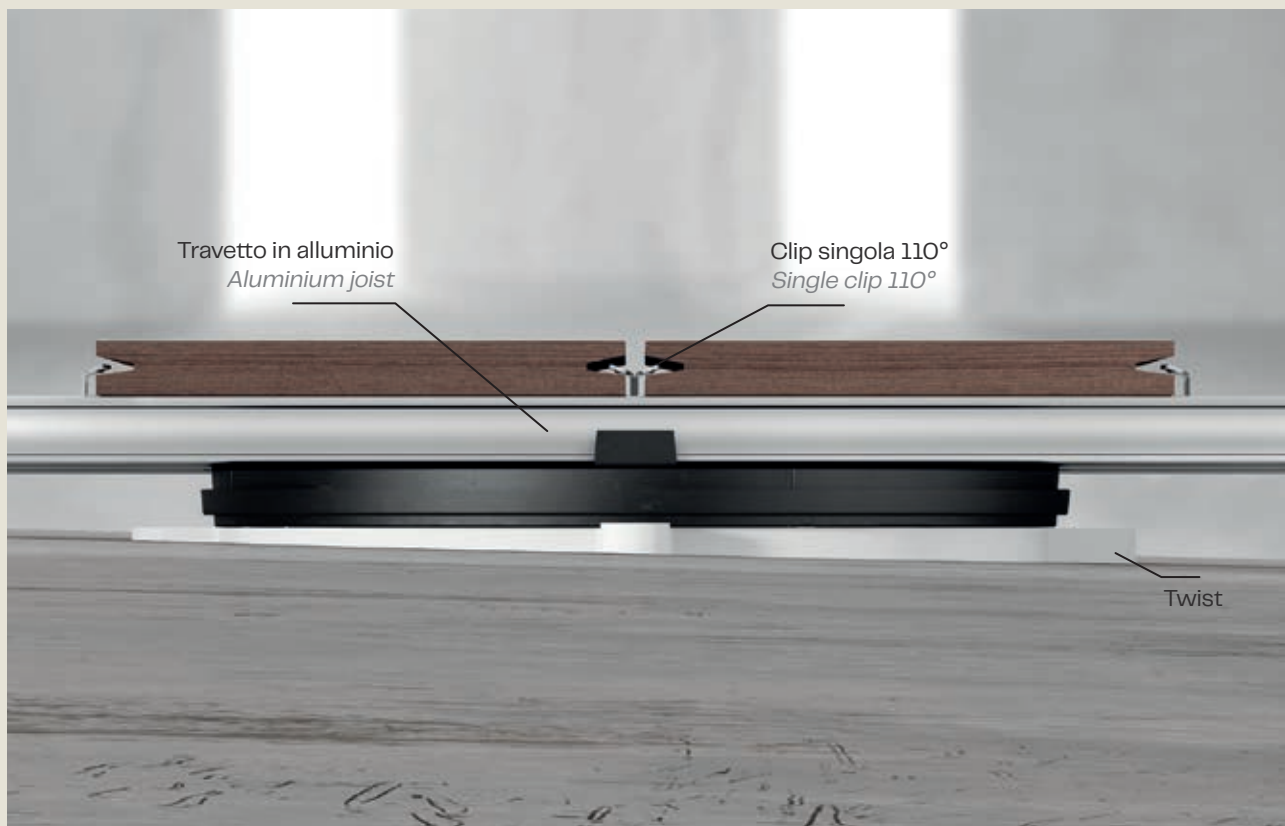

Supporto Star.T Star.T support

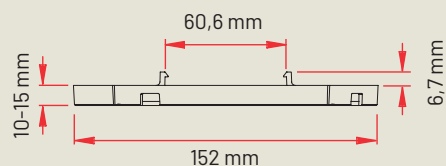

Prolunga Star.T Star.T extension

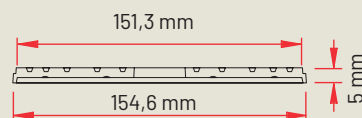

CODICE CODE	DESCRIZIONE DESCRIPTION	MISURA SIZE	PAG. LISTINO PRICE LIST PAGE	PZ KIT	PZ 	PZ 
E003011515	Star.T per travetto in alluminio <i>Star.T for aluminium joist</i>	10-15 mm	25	-	100	5400
E003100025	Prolunga Star.T <i>Star.T Extension</i>	5 mm	25	20	100	9600

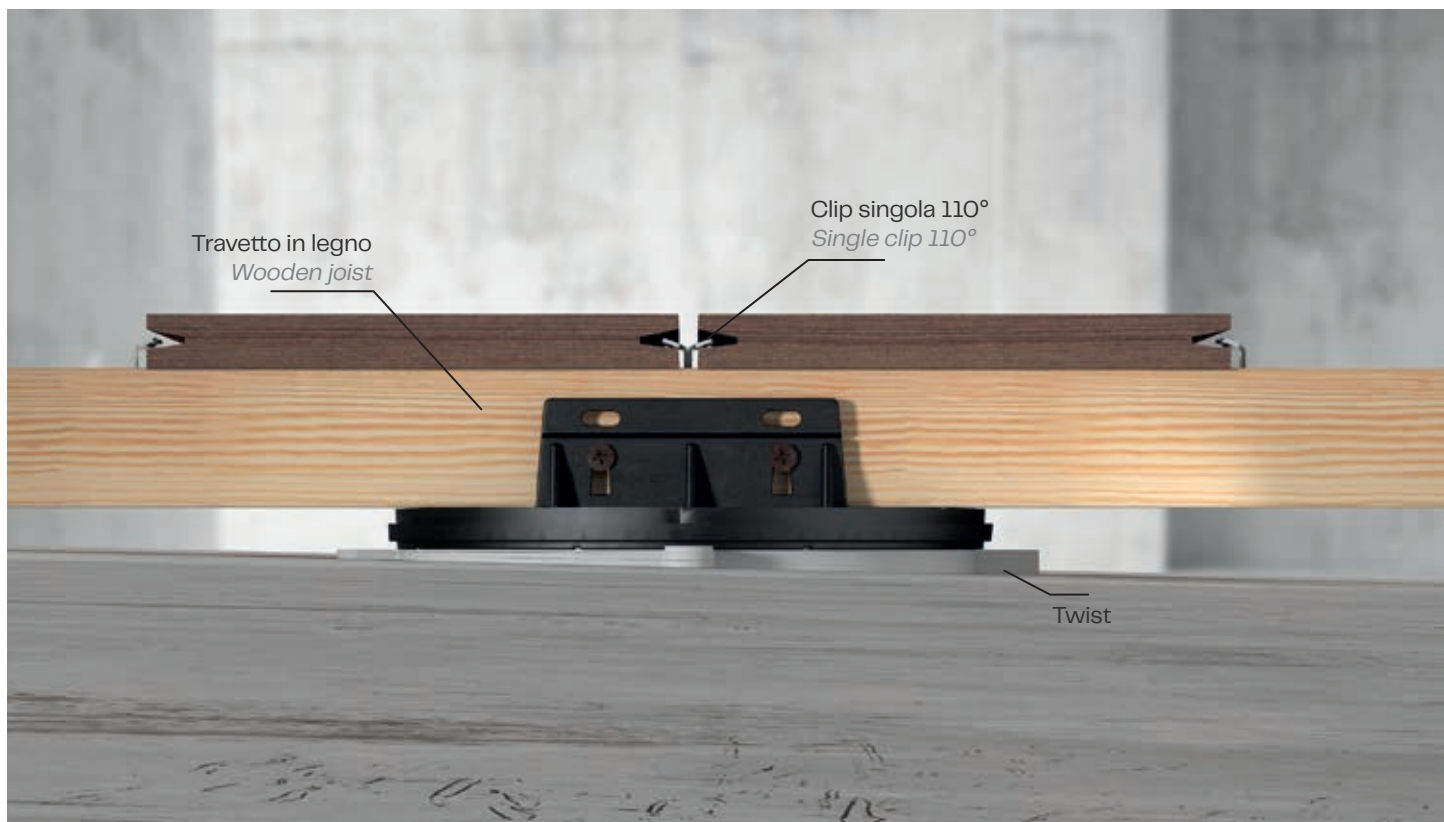

Supporto Star.T per posa su travetto in legno

Star.T support for decking



CODICE CODE	DESCRIZIONE DESCRIPTION	MISURA SIZE	PAG. LISTINO PRICE LIST PAGE	PZ KIT	PZ	PZ
E003011115	Star.T senza alette <i>Star.T without tabs</i>	10-15 mm	25	-	100	5400
E003920100	Aletta Star.T per travetto in legno <i>Star.T flap for decking</i>	-	25	-	500	35000
E003100025	Prolunga Star.T <i>Star.T Extension</i>	5 mm	25	20	100	480
Q193000203	Vite a croce per legno <i>Phillips Screw for wood</i>	Ø 3,5 mm L 20 mm	25	-	1000	-

Supporto Star.T

Star.T support

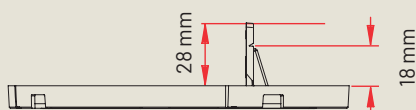

Prolunga Star.T

Star.T extension

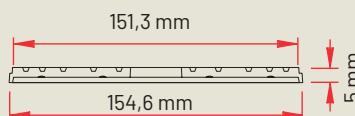

Dettaglio: aletta preincisa

Detail: pre-cut flap

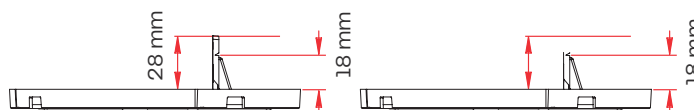

FOCUS

Aletta preincisa

Pre-cut flap



Dettaglio testa avvitata su travetto in legno.

Detail head screwed onto wooden joist.

Utilizzi componenti Star.T

Possible uses of Star.T components

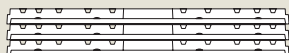

3 Prolunghe Star.T
3 Star.T Extensions
 H 5 mm + 5 mm + 5 mm



Star.T
 H 15 mm

H 30 mm



2 Prolunghe Star.T
2 Star.T Extensions
 H 5 mm + 5 mm

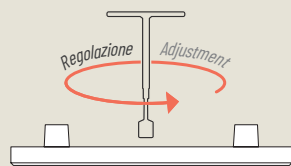

Star.T
 H 15 mm

H 25 mm



Prolunga Star.T
Star.T Extension
 H 5 mm

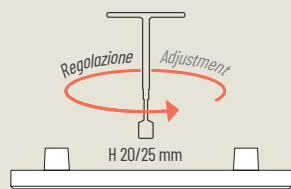

Star.T
 H 15 mm

H 20 mm

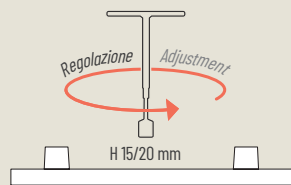

Star.T
 H 15 mm

H 15 mm

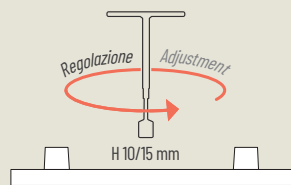

Star.T
 H 10 mm

H 10 mm

In alternativa
As alternative



Supporto Pedestal Prime PR 1
da H 30 mm



Supporto Eterno SE O
da H 28 mm



Supporto Basic SB 1
da H 27 mm



Supporto Reversus SR/SRT 1
da H 26 mm



Supporto New Maxi NM 1
da H 25 mm



Supporto New Maxi NM O
da H 15 mm

Utilizzando 2 Prolunghe Star.T in abbinamento al supporto Star.T è possibile raggiungere un'altezza di 25 mm: da questa altezza è possibile utilizzare i supporti NM.

Utilizzando 3 Prolunghe Star.T in abbinamento al supporto Star.T è possibile raggiungere un'altezza di 30 mm, altezza oltre la quale è possibile utilizzare i supporti PR, SR/SRT, SE, NM ed SB.

Using 2 Star.T Extensions with the Star.T support you can reach a height of 25 mm: from this height you can use the NM supports.

Using 3 Star.T Extensions with the Star.T support you can reach a height of 30 mm, above this height, PR, SR/SRT, SE, NM and SB supports can be used.



SUPPORTI ALTEZZA FISSA

FIXED HEIGHT
SUPPORTS

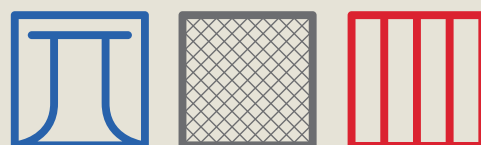

La linea di supporti con altezza fissa di Eterno Ivica rappresenta la soluzione più rapida ed economica per la posa di lastre.

Grazie alle sue diverse gamme, EH Rubber, EH, DM e CR i supporti ad altezza fissa sono un ottimo alleato per realizzare pavimenti sopraelevati da esterno facilmente e velocemente.

The fixed height supports line by Eterno Ivica represents the quickest and cheapest solution solution for laying slabs.

Thanks to its three different ranges EH Rubber, EH, DM and CR, the fixed height supports are a great service to realize outdoor raised floor in an easy and fast way.

EHR 10+6

EH Rubber Eh Rubber



Utilizzabile con qualsiasi pavimentazione da esterno autoportante
Can be used in conjunction with any outdoor flooring



Totalmente riciclabile
Fully recyclable



Testa con parte superiore in gomma antirumore e antiscivolo
Head with upper part in noise-reducing anti-slip rubber

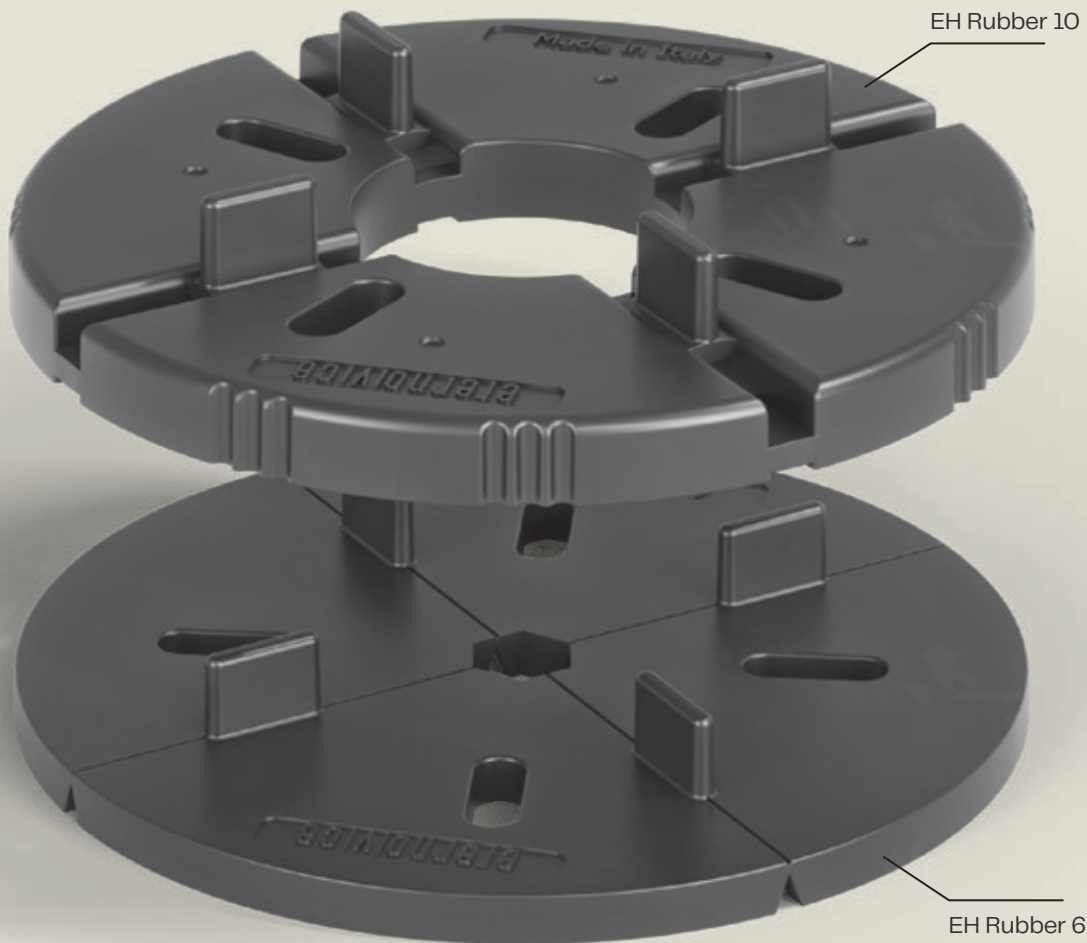

EHR 10+6

Supporto in gomma Rubber support



EH RUBBER 10+6 è un supporto in gomma SBS riciclabile progettato e prodotto in Italia. Il materiale usato è particolarmente resistente agli sbalzi di temperatura, alle soluzioni acide e agli agenti atmosferici che lo rendono particolarmente adatto all'uso in esterno.

Soggetto a grande performance di schiacciamento, grazie al suo potere elastico, ritorna alla forma originaria. Esso ha un'alta proprietà nell'abbattimento acustico e la sua composizione è formulata appositamente per eguagliare l'alta performance della "testa bianca" presente nei modelli PR, SR/SRT, SE e NM della linea Pedestal.

EH RUBBER 10+6 is a support made of SBS recyclable rubber, designed and manufactured in Italy. The material used has a particularly high resistance to temperature changes, acid solutions and atmospheric agents that make it mostly suitable for outdoor use.

It is subject to great crushing performance, thanks to its elastic power, it returns to its original shape. It has a high sound absorbing property and its composition is formulated specifically to match the high performance of the "white head" present in the PR, SR/SRT, SE and NM models belonging to the Pedestal line.



Supporto con portata certificata
Tested for loading bearing capacity

EHR 10+6

Caratteristiche Features

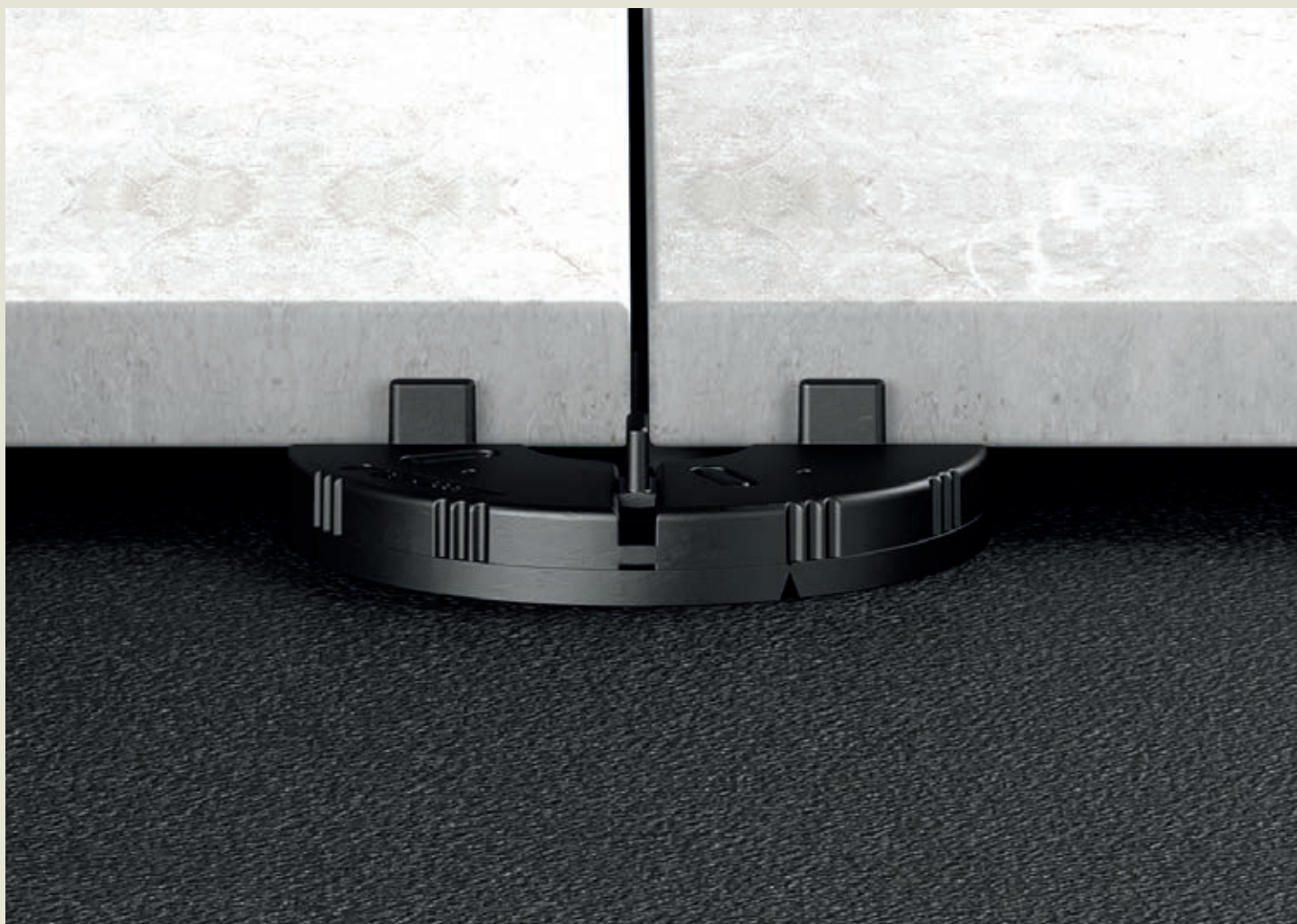

Rapido e polivalente.

Le alette del supporto hanno un'altezza standard di 10 mm e uno spessore di 4 mm.

Su richiesta le alette sono disponibili anche con lo spessore idoneo alla posa per fughe da 2 e 3 mm.

Grazie alla sua materia prima e ai suoi ridotti ingombri, EH RUBBER 10+6 diventa un ottimo alleato nel campo dell'edilizia e dell'architettura, assicurando un'elevata velocità di posa in opera, un migliore isolamento acustico e garantendo alla pavimentazione un ottimo risultato finale. Può sopraelevare qualsiasi tipo di finitura (pietra, ceramica, cemento, materiale composito, etc...) di qualsiasi formato e peso.

Fast and versatile.

The tab of the Pedestal are 10 mm high and 4 mm thick, standard.

On request, the tabs are also available with the required thickness to be used for 2 and 3 mm joints.

Because of its raw material and its compact size, EH RUBBER 10+6 becomes a great ally in the construction field and in architecture; ensuring high speed during installation procedures, better sound insulation and granting a good floor finishing results. It can raise any type of floor finish (stone, ceramic, cement, composite material, etc...) of any size and weight.

EHR 10+6

Misure Size



**EH
RUBBER 10**

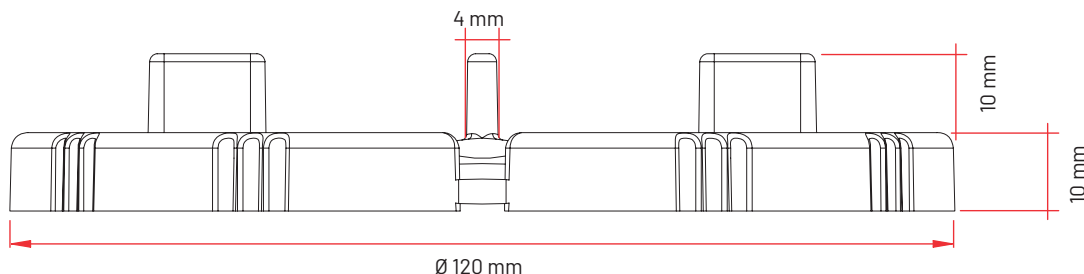

**EH
RUBBER 6**

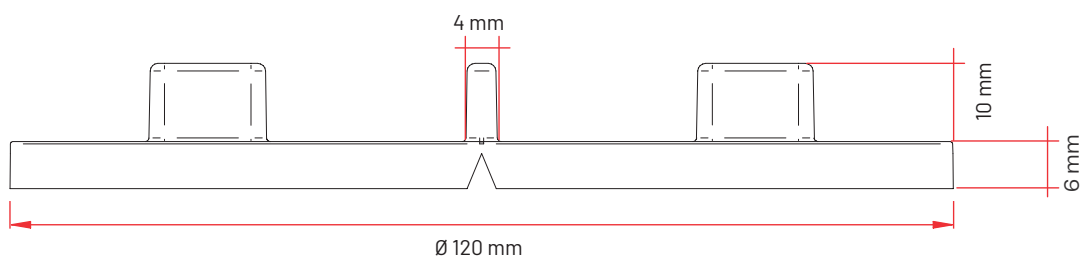

Utilizzi potenziali Potential uses

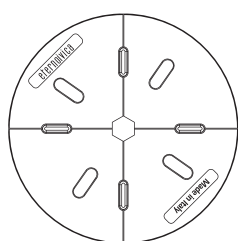

4/4

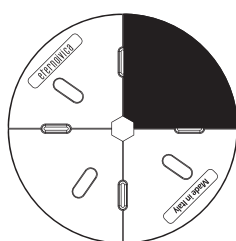

3/4

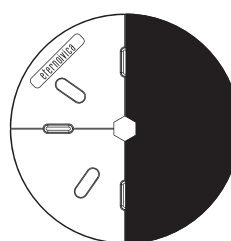

2/4

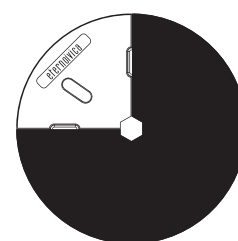

1/4

Il supporto EH Rubber 10+6 può essere usato intero, a metà o in sezioni di quarti.

The EH Rubber 10+6 support can be used entire, half or divided into quarter sections.

CODICE CODE	DESCRIZIONE DESCRIPTION	MISURA SIZE	PAG. LISTINO PRICE LIST PAGE	PZ 	PZ
E000010004	EH Rubber 10 aletta 4 mm H 10 mm <i>EH Rubber 10 with tab 4 mm H 10 mm</i>	10 mm	28	150	-
E000006004	EH Rubber 6 aletta 4 mm H 10 mm <i>EH Rubber 6 with tab 4 mm H 10 mm</i>	6 mm	28	150	-

Alette spessore 2, 3 mm disponibili su richiesta.

Tabs 2, 3 mm thick available on request.

EH 12, 15, 20

EH 12, 15, 20

EH 12, 15, 20



EH 12



EH 15



EH 20

EH

12, 15, 20

Supporto ad altezza fissa

EH 12, 15, 20

Rubber support EH 12, 15, 20



Utilizzabile con qualsiasi pavimentazione da esterno autoportante
Can be used in conjunction with any outdoor flooring



Totalmente riciclabile
Fully recyclable



Resistente agli agenti atmosferici, agli acidi, all'invecchiamento, ai raggi UV
Resistant to weathering, acids, UV rays and wear and tear

I supporti ad altezza fissa sono disponibili in tre versioni: il modello EH 12 (H 12 mm), EH 15 (H 15 mm) e EH 20 (H 20 mm).

Da sempre rappresentano la soluzione più rapida ed economica per la posa di lastre nel sistema sopraelevato. In caso di dislivello o imperfezioni del sottofondo, sono disponibili 4 esclusivi equilibratori basculanti che provvedono automaticamente al livellamento di piccole imperfezioni del pavimento.

È inoltre disponibile uno specifico modello di supporto EH 12 con alette alte 8 mm per la posa di apposite lastre autoportanti con spessore 20 mm.

Il disco livellatore LH3 (spessore 3 mm) può infine essere utilizzato sopra o sotto qualsiasi supporto e funge da spessore per uno o più settori del medesimo.

The fixed height supports are available in three versions: the EH 12 (H 12 mm), EH 15 (H 15 mm) and EH 20 (H 20 mm) models.

They have always been the quickest and most economical solution for installing slabs in the raised system. In the event of a difference in height or imperfections of the substrate, there are 4 exclusive tilting balancers which automatically provide for the leveling of small floor imperfections.

A specific EH 12 support model with 8 mm high tabs is also available for installing self-bearing 20 mm thick self-supporting slabs.

The leveling disc LH3 (thickness 3 mm) can finally be used above or below any support, and acts as a thickness for one or more sectors of itself.



Equilibratore
Balancer



Supporto con portata certificata
Tested for loading bearing capacity

EH 12, 15, 20

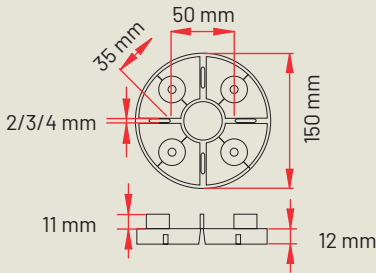

EH 12

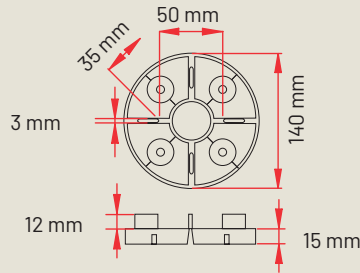

EH 15

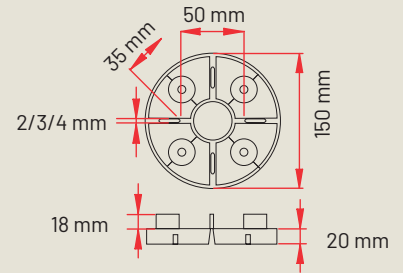

EH 20



CODICE CODE	DESCRIZIONE DESCRIPTION	SPESSORE ALETTE TABS THICKNESS	ALTEZZA ALETTE TABS HEIGHT	MISURA SIZE	PAG. LISTINO PRICE LIST PAGE	PZ 	PZ
E008012008	EH 12 - alette H8 mm <i>EH 12 - tabs H8 mm</i>	2,5	8	12 mm	28	250	5000
E000012003	EH 12*	3	11	12 mm	28	250	5000
E000015000	EH 15	3	12	15 mm	28	200	4000
E002020000	EH 20**	4	18	20 mm	28	150	3000
E050005000.200	Equilibratore <i>Balancer</i>	-	-	5 mm	28	3000 (sacchetti da 200pz.) <i>(bags of 200pcs.)</i>	-

* Alette spessore 2, 4 mm disponibili su richiesta.
** Alette spessore 2, 3 mm disponibili su richiesta.

* Tabs 2, 4 mm thick available on request.
** Tabs 2, 3 mm thick available on request.

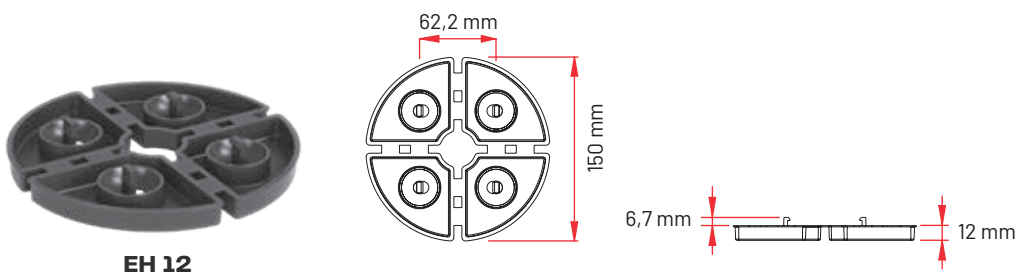
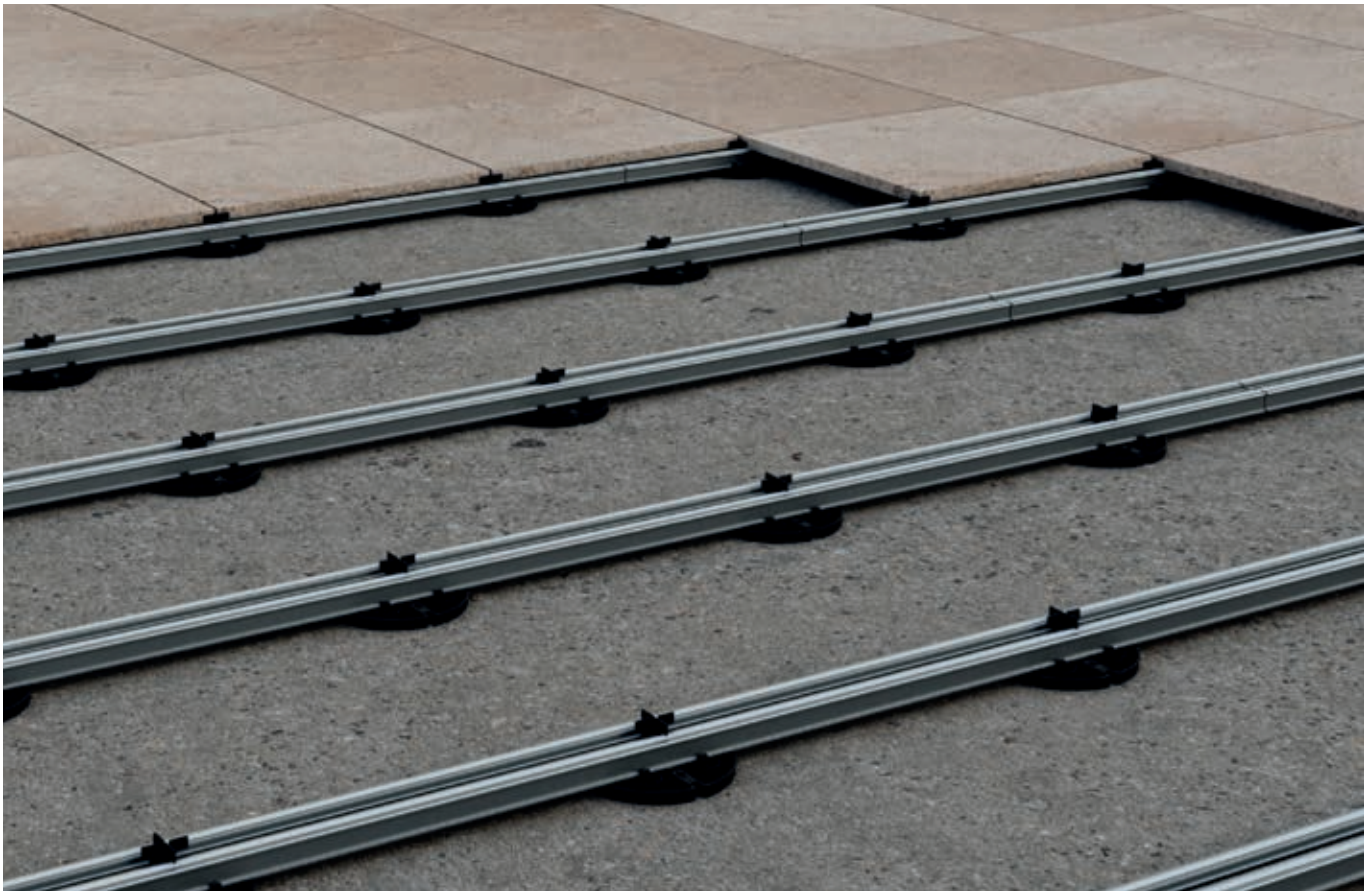
EH 12



CODICE CODE	DESCRIZIONE DESCRIPTION	MISURA SIZE	PAG. LISTINO PRICE LIST PAGE	PZ 	PZ 
E000016000	EH 12 per travetto in alluminio <i>EH 12 for aluminium joist</i>	12 mm	28	250	5000

DM

Distanziatore mini sabbia/erba/ghiaia

Mini spacer for sand/grass/
gravel

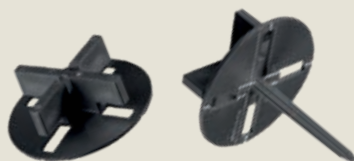

Il Distanziatore Mini DM è un sistema estremamente versatile ed efficace nella sua semplicità, studiato per il posizionamento di lastre su fondi sabbiosi, erba o ghiaia.

Il supporto, di piccole dimensioni, viene fornito nelle versioni senza o con puntale; quest'ultimo garantisce miglior ancoraggio e stabilità.

The Mini DM Spacer is an extremely versatile and efficient system in its simplicity, designed for positioning slabs on sandy bottoms, grass or gravel.

The small-sized spacer is provided without or with aglet. In the second case, it guarantees a better anchoring and stability.



Distanziatore Mini DM senza puntale per i fondi in ghiaia

Mini DM Spacer without aglet for gravel ground



Distanziatore Mini DM con puntale per i fondi in sabbia e erba

Mini DM Spacer for surfaces in sand and grass

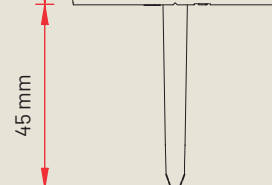
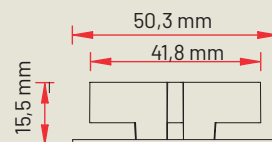
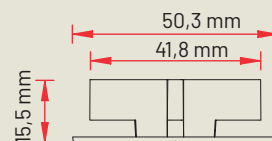

Distanziatore Mini DM vista dall'alto

Mini DM Spacer top view

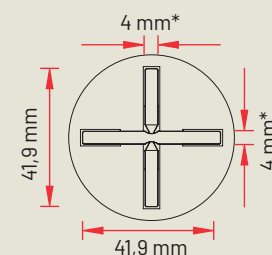

CODICE CODE	DESCRIZIONE DESCRIPTION	ALTEZZA HEIGHT	LARGHEZZA LENGHT	PAG. LISTINO PRICE LIST PAGE	PZ** 
E004000205	Distanziatore MINI DM con puntale* <i>MINI DM spacer with aglet*</i>	60,5 mm	50,3 mm	29	500
E004000215	Distanziatore MINI DM senza puntale* <i>MINI DM spacer without aglet*</i>	15,5 mm	50,3 mm	29	500

* Alette con spessore standard 4 mm H 12 mm, su richiesta 2 - 3 mm.

** Le scatole sono composte da 5 sacchetti da pz. 100.

** Standard tabs are 4 mm thick H 12 mm. On request also 2 - 3 mm.*

*** The boxes are made up of 5 x 100 pieces bags.*

CR

Crocette sabbia/erba/ghiaia

Cross spacer for sand/grass/gravel

La Crocetta CR è un sistema alternativo al precedente per la posa su fondi sabbiosi, erba o ghiaia. È fornito in due versioni, con altezza 15 mm o 20 mm, lo spessore delle alette è di 2-3-4 mm.

The Cross Spacer CR is an alternative system to the previous one for the installation on sandy grave, on grass or gravel. It is provided in two versions, with a height of 15 mm or 20 mm and the tabs thickness is 2-3-4 mm.

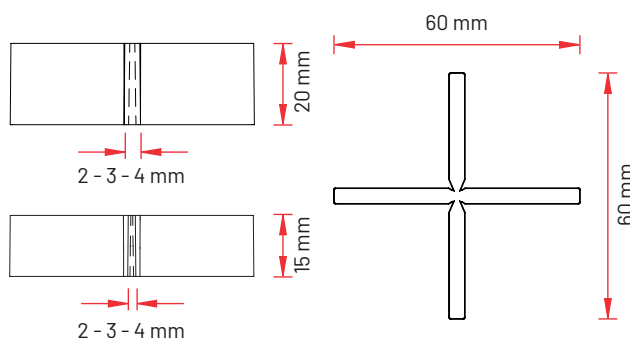

Crocetta CR
vista dall'alto
Cross spacer
CR top view

CODICE CODE	DESCRIZIONE DESCRIPTION	MISURA SIZE	PAG. LISTINO PRICE LIST PAGE	PZ* 
P021000052	Crocette in PP PP Spreaders	H 15 mm spessore 2 mm H 15 mm thickness 2 mm	29	500
P021000053	Crocette in PP PP Spreaders	H 15 mm spessore 3 mm H 15 mm thickness 3 mm	29	500
P021000054	Crocette in PP PP Spreaders	H 15 mm spessore 4 mm H 15 mm thickness 4 mm	29	500
P021000062	Crocette in PP PP Spreaders	H 20 mm spessore 2 mm H 20 mm thickness 2 mm	29	500
P021000063	Crocette in PP PP Spreaders	H 20 mm spessore 3 mm H 20 mm thickness 3 mm	29	500
P021000064	Crocette in PP PP Spreaders	H 20 mm spessore 4 mm H 20 mm thickness 4 mm	29	500

*Le scatole sono composte da 5 sacchetti da pz. 100.

*The boxes are made up of 5 x 100 pieces bags.

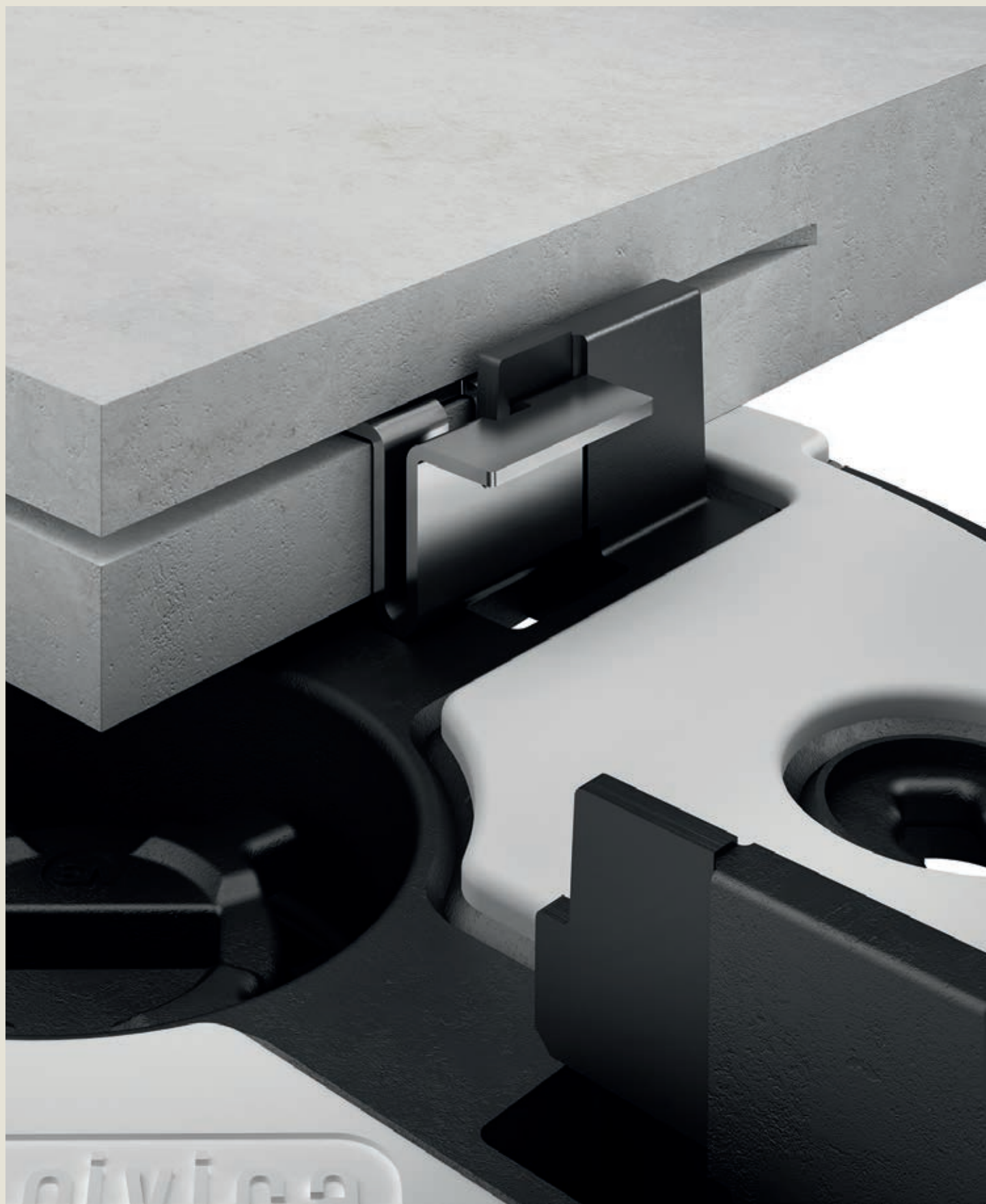

SUPPORTI SPECIALI

SPECIAL SUPPORTS

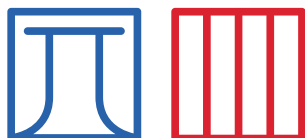

Dopo anni di esperienza nel settore dei supporti per pavimentazioni sopraelevate da esterno, Eterno Ivica, sempre attenta allo sviluppo del mercato e alle esigenze dei clienti, ha realizzato una linea di supporti speciali studiati apposta per particolari necessità.

È così che sono nati i supporti della linea Antivento PR W, SE W e NM W, i supporti della linea Silent PR S, SR/SRT S, SE S e NM S.

After years of experience in the field of raised floors for outdoor floors, Eterno Ivica, always attentive to market development and customer needs, has created a line of special supports designed specifically for special needs.

This is how the supports of the Windproof line were born, PR W, SE W and NM W; the supports of the line Silent PR S, SR/SRT S, SE S and NM S.

Supporti antivento

Windproof system



Guarda il video di presentazione



Watch the presentation video



Il sistema antivento è studiato per risolvere in modo sicuro, definitivo ed economico il problema del sollevamento delle lastre causato dal vento.

Il sistema garantisce un legame solido tra le lastre di pavimentazione e i supporti ed è costituito da clip metalliche che si inseriscono nelle alette distanziatrici dei supporti che, grazie alla particolare conformazione a "T" o a "L", bloccano le lastre di pavimentazione.

Le stesse dovranno essere fresate nei 4 angoli in modo da permettere l'inserimento delle clip.

The windproof system is designed to solve the problem of slab lifting caused by the wind in a safe, permanent and economical way.

The system guarantees a solid bond between the flooring slabs and the supports, and it consists of metal clips that are inserted into the spacer fins of the supports which, thanks to the particular "T" or "L" shape, block the flooring slabs.

The slabs must be sanded in the 4 corners in order to allow the insertion of the clips.

Testa antivento
Windproof head



Clip a forma "L"
"L" shaped clip



Clip a forma "T"
"T" shaped clip

PR W

Pedestal Prime[®] antivento

Pedestal Prime[®] windproof system

- Invisibile, la pavimentazione mantiene la sua estetica
 - Rimovibile, permette l'ispezionabilità del piano di posa sottostante con la semplice rimozione degli elementi
 - Mantiene inalterata la possibilità di regolare i supporti in altezza anche a pavimento finito
 - Non necessita di collanti o viti
 - Assorbe le dilatazioni e i movimenti strutturali
 - Si può installare anche su terrazze già finite
 - È compatibile con qualsiasi tipologia di lastre, listoni, doghe
- *Invisible, the flooring maintains its original aesthetic*
 - *Removable, It allows for the inspection of the underlying surface with the simple removal of the elements*
 - *Adjustable. You can still adjust the supports in height, even on the finished floor*
 - *It does not require adhesives or screws*
 - *Absorbs expansion and structural movements*
 - *It can also be installed on pre-existing terraces*
 - *It is compatible with any type of slabs, planks, slats*



SE W

Eterno antivento Eterno windproof system

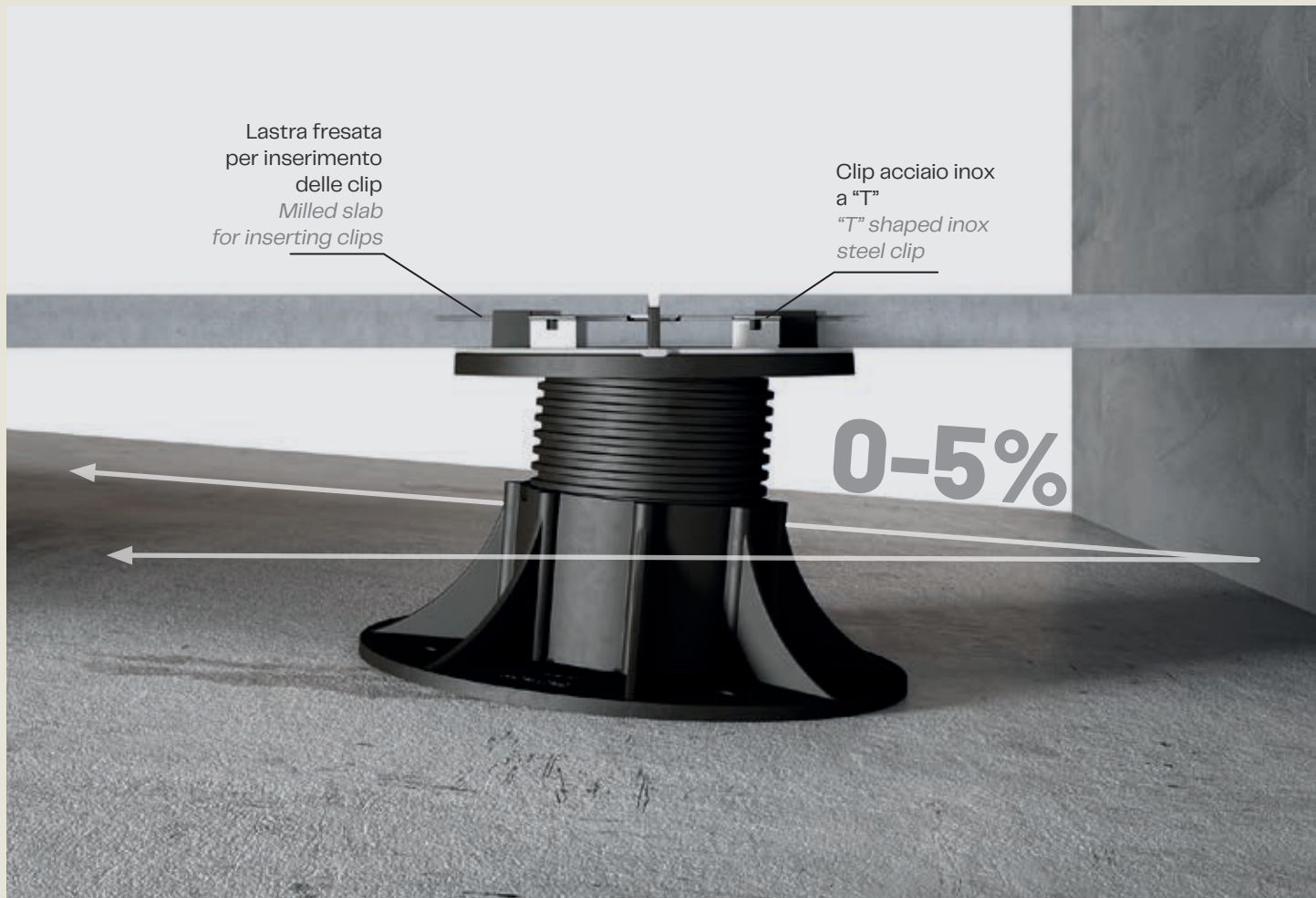
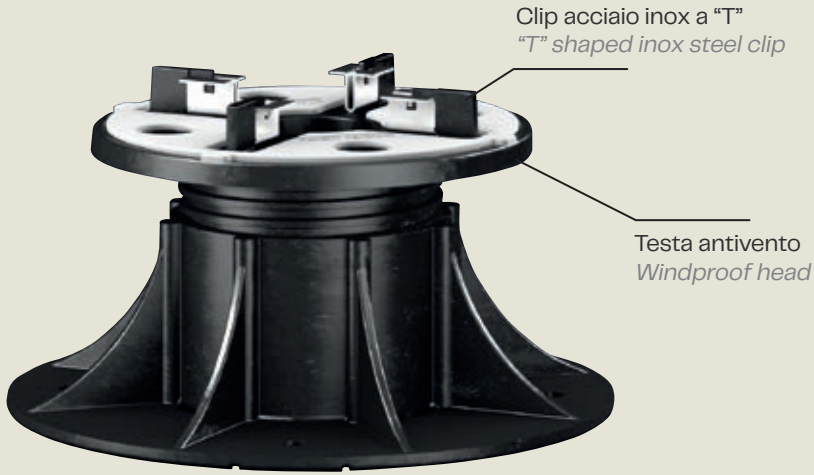

NM W

New Maxi antivento

New Maxi windproof system

- Invisibile, la pavimentazione mantiene la sua estetica
 - Rimovibile, permette l'ispezionabilità del piano di posa sottostante con la semplice rimozione degli elementi
 - Mantiene inalterata la possibilità di regolare i supporti in altezza anche a pavimento finito
 - Non necessita di collanti o viti
 - Assorbe le dilatazioni e i movimenti strutturali
 - Si può installare anche su terrazze già finite
 - È compatibile con qualsiasi tipologia di lastre, listoni, doghe
- *Invisible, the flooring maintains its original aesthetic*
 - *Removable, It allows for the inspection of the underlying surface with the simple removal of the elements*
 - *Adjustable. You can still adjust the supports in height, even on the finished floor*
 - *It does not require adhesives or screws*
 - *Absorbs expansion and structural movements*
 - *It can also be installed on pre-existing terraces*
 - *It is compatible with any type of slabs, planks, slats*

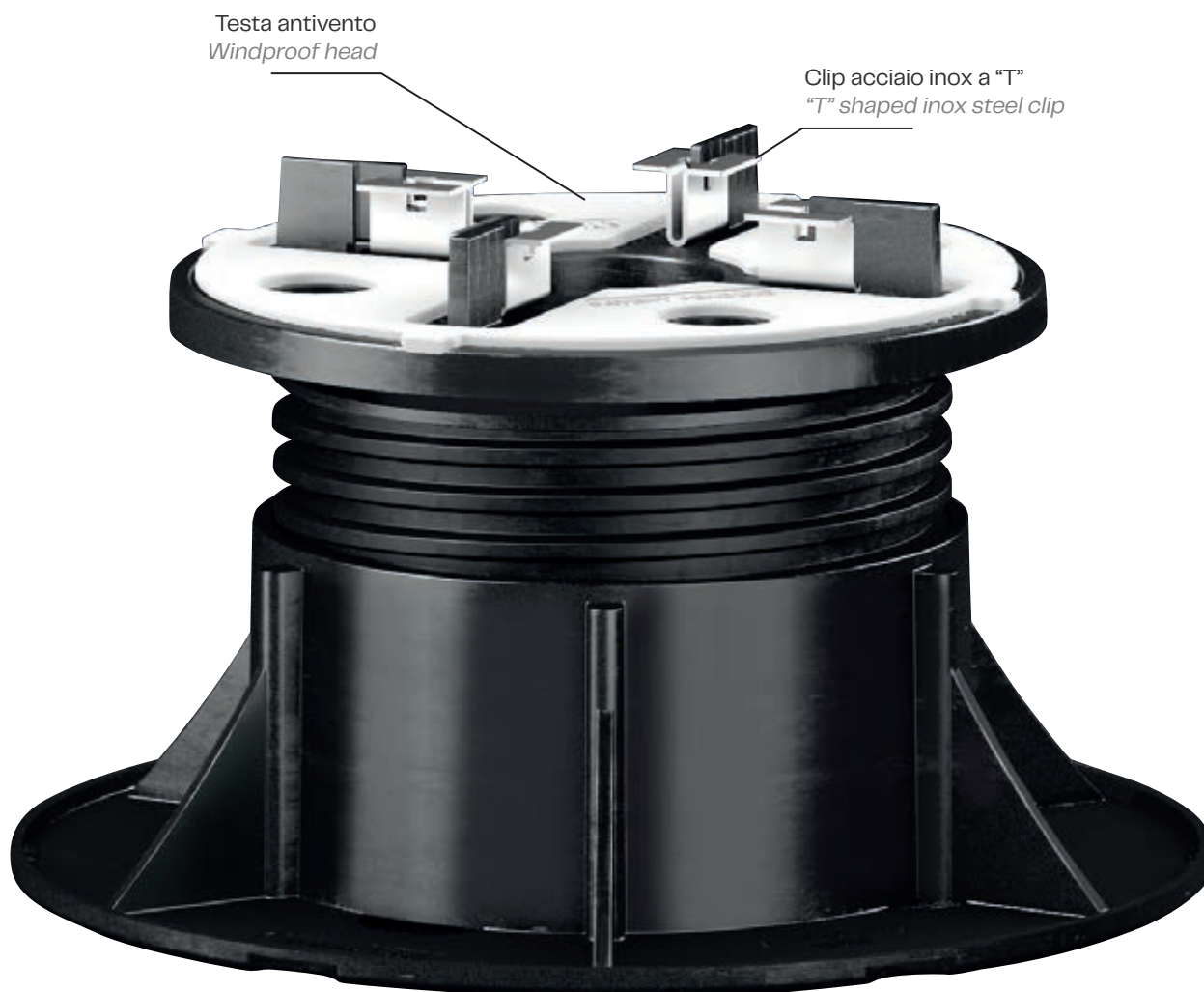

SE W

Sistema antivento con supporto Eterno
Windproof system with Eterno support



CODICE CODE	DESCRIZIONE DESCRIPTION	MISURA SIZE	PAG. LISTINO PRICE LIST PAGE	PZ 	PZ 
E440030040	SE W 0	30-40 mm	33	25	1500
E440039052	SE W 1	39,5-52 mm	33	25	1200
E440052077	SE W 2	52-77 mm	33	25	1200
E440077122	SE W 3	77-122 mm	33	25	800
E440122172	SE W 4	122-172 mm	33	25	600
E440172217	SE W 5	172-217 mm	33	25	600
E440142232	SE W 6	142-232 mm	33	-	-
E440187277	SE W 7	187-277 mm	33	-	-
E440237327	SE W 8	237-327 mm	33	-	-
E440207347	SE W 9	207-347 mm	33	-	-
E440252387	SE W 10	252-387 mm	33	-	-
E440302402	SE W 11	302-402 mm	33	-	-
E440272457	SE W 12	272-457 mm	33	-	-
E440317502	SE W 13	317-502 mm	33	-	-
E440367552	SE W 14	367-552 mm	33	-	-
E035211204	Testa bicomponente autolivellante antivento XLW <i>Two-component self-levelling windproof XLW head</i>	Ø 150 mm	33	100	-
E130125000	Prolunga P1* <i>P1 Extension*</i>	-	33	25	1050
Q200000310	Clip antivento sezione a "T" <i>Windproof clip with "T" section</i>	-	33	100	-
Q200000320	Clip antivento sezione a "L" <i>Windproof clip with "L" section</i>	-	33	100	-

NB: I codici dei supporti si riferiscono al modello con testa autolivellante XLW antivento con alette spessore 4 mm H 14 mm.

* Prolunga utilizzabile solo con supporti da SEW 3 a SEW 5.

NB: The supports codes refer to type with self-levelling windproof XLW head with 4 mm thick tabs, H 14 mm.

* Extension element suitable only to types from SEW 3 to SEW 5.

PR W

Sistema antivento con supporto Pedestal Prime®

Windproof system with Pedestal Prime® support



CODICE CODE	DESCRIZIONE DESCRIPTION	MISURA SIZE	PAG. LISTINO PRICE LIST PAGE	PZ 	PZ
E507200347	PR W 1	34-69 mm	32	25	1350
E507207016	PR W 2	69-159 mm	32	25	750
E507216042	PR W 3	159-424 mm	32	12	360
E035211204	Testa bicomponente autolivellante antivento XLW <i>Two-component self-levelling windproof XLW head</i>	Ø 150 mm	32	100	-
E501000190	Prolunga PR* <i>PR Extension*</i>	-	32	12	-
Q200000310	Clip antivento sezione a "T" <i>Windproof clip with "T" section</i>	-	32	100	-
Q200000320	Clip antivento sezione a "L" <i>Windproof clip with "L" section</i>	-	32	100	-

NB: I codici dei supporti si riferiscono al modello con testa fissa antivento XLW con alette spessore 4 mm H 14 mm.

* Utilizzabile con PR3.

NB: The supports codes refer to type with fixed windproof XLW head with 4 mm thick tabs, H 14 mm.

* Usable with PR3.

NM W

Sistema antivento con supporto New Maxi Windproof system with New Maxi support



CODICE CODE	DESCRIZIONE DESCRIPTION	MISURA SIZE	PAG. LISTINO PRICE LIST PAGE	PZ 	PZ
E014020030	NM W 0	20-30 mm	34	20	1680
E014030047	NM W 1	30-45 mm	34	20	1320
E014045077	NM W 2	45-75 mm	34	20	960
E014065107	NM W 3	65-105 mm	34	20	720
E014095167	NM W 4	95-165 mm	34	20	600
E014155277	NM W 5	155-275 mm	34	20	420
E035091204	Testa bicomponente fissa antivento XLW <i>Two-component fixed windproof XLW head</i>	Ø 150 mm	34	100	-
E044000145	Prolunga PNM* <i>PNM Extension*</i>	-	34	30	600
Q200000310	Clip antivento sezione a "T" <i>Windproof clip with "T" section</i>	-	34	100	-
Q200000320	Clip antivento sezione a "L" <i>Windproof clip with "L" section</i>	-	34	100	-

NB: I codici dei supporti si riferiscono al modello con testa fissa antivento XLW con alette spessore 4 mm H 14 mm.

* Prolunga utilizzabile solo con supporti da NMW 3 a NMW 5.

NB: The supports codes refer to type with fixed windproof XLW head with 4 mm thick tabs, H 14 mm.

* Extension element suitable only to types from NMW 3 to NMW 5.

PR S Pedestal Prime® Silent

Pedestal Prime® Silent

Test di laboratorio effettuato su un solaio campione composto da getto unico in cls armato di sp. 140 mm, strato isolante espanso a celle chiuse, piastrelle in gres 60x60 cm, posate su PR2 in polipropilene e gomma. Il sistema garantisce un abbattimento acustico ΔL_w di 22 dB.

Laboratory test carried out on a sample floor composed of a single cast in reinforced concrete with a thickness of 140 mm, closed-cell foam insulation layer, 60x60 cm porcelain slabs laid on polypropylene and rubber PR2 supports. The system provides a sound reduction of 22 dB in terms of ΔL_w .

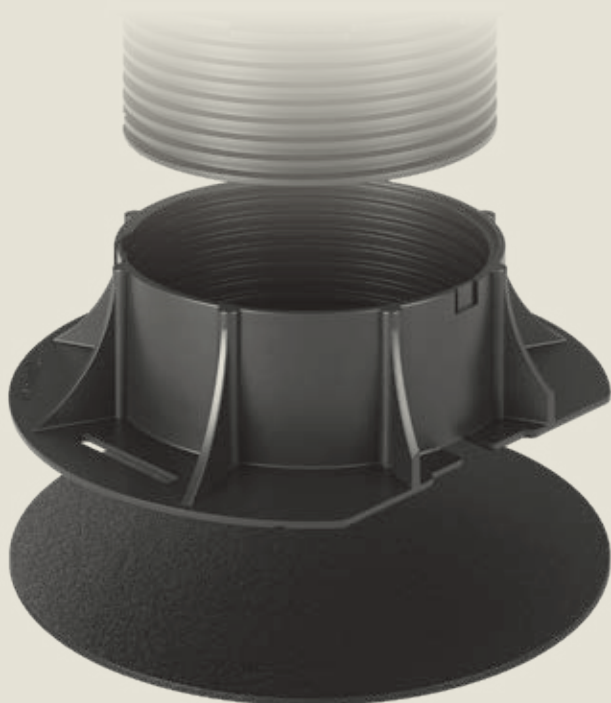

Strato isolante espanso modificato a celle chiuse ad alta densità, spessore 3 mm.
High-density, closed-cell, 3 mm thick foam insulating layer.

Abbattimento acustico Noise reduction

ΔL_w 22 dB

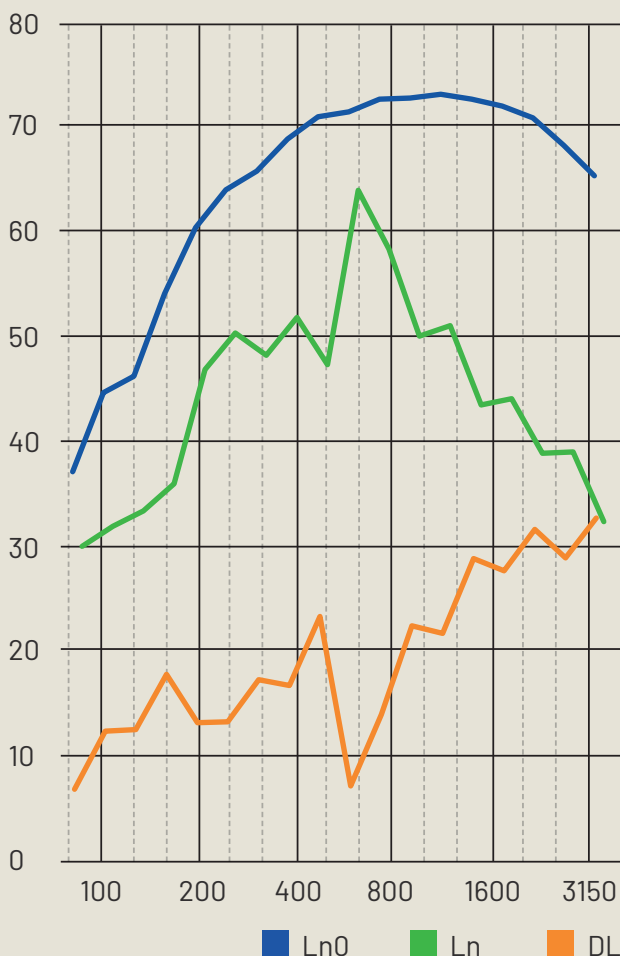

Identificazione delle norme di riferimento: EN ISO 10140-3: 2021
Acustica - misurazione in laboratorio dell'isolamento acustico di edifici e di elementi di edificio: misurazione dell'isolamento del rumore da calpestio.

Identification of reference standards: EN ISO 10140-3: 2021
Acoustics - Laboratory measurement of building and building element sound insulation: Measurement of impact sound insulation.

SR/SRT S Reversus® Silent

Reversus® Silent

Test di laboratorio effettuato su un solaio campione composto da getto unico in cls armato di sp. 140 mm, strato isolante espanso a celle chiuse, piastrelle in gres 60x60 cm, posate su SR3 in polipropilene e gomma. Il sistema garantisce un abbattimento acustico ΔL_w di 22 dB.

Laboratory test carried out on a sample floor composed of a single cast in reinforced concrete with a thickness of 140 mm, closed-cell foam insulation layer, 60x60 cm porcelain slabs laid on polypropylene and rubber SR3 supports. The system provides a sound reduction of 22 dB in terms of ΔL_w .



Strato isolante espanso modificato a celle chiuse ad alta densità, spessore 3 mm.
High-density, closed-cell, 3 mm thick foam insulating layer.

Abbattimento acustico Noise reduction

ΔL_w **22 dB**

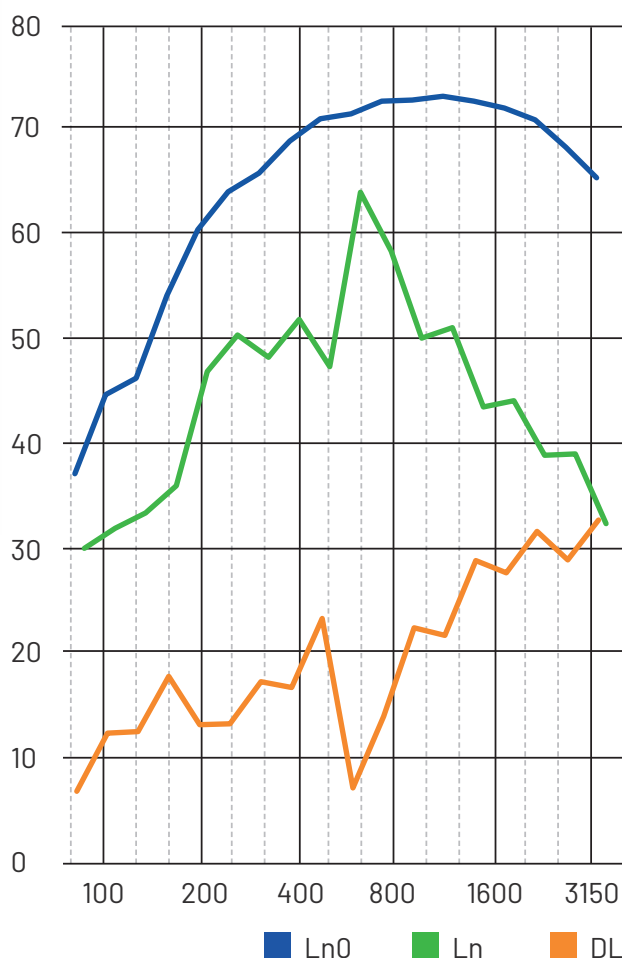

Identificazione delle norme di riferimento: EN ISO 10140-3: 2021
Acustica - misurazione in laboratorio dell'isolamento acustico di edifici e di elementi di edificio: misurazione dell'isolamento del rumore da calpestio.

Identification of reference standards: EN ISO 10140-3: 2021
Acoustics - Laboratory measurement of building and building element sound insulation: Measurement of impact sound insulation.

SE S

Eterno Silent

Eterno Silent

Test di laboratorio effettuato su un solaio campione composto da getto unico in cls armato di sp. 140 mm, strato isolante espanso a celle chiuse, piastrelle in gres 60x60 cm, posate su SE3 in polipropilene e gomma. Il sistema garantisce un abbattimento acustico ΔL_w di 24 dB.

Laboratory test carried out on a sample floor composed of a single cast in reinforced concrete with a thickness of 140 mm, closed-cell foam insulation layer, 60x60 cm porcelain slabs laid on polypropylene and rubber SE3 supports. The system provides a sound reduction of 24 dB in terms of ΔL_w .

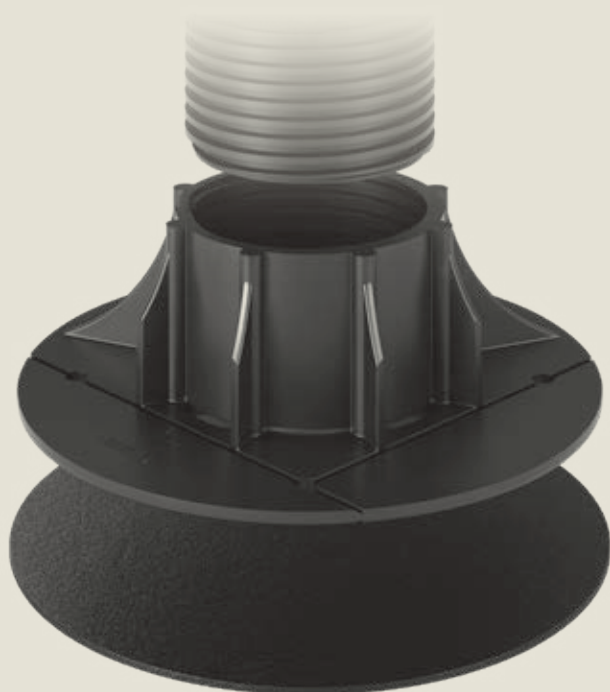

Strato isolante espanso modificato a celle chiuse ad alta densità, spessore 3 mm.
High-density, closed-cell, 3 mm thick foam insulating layer.

Abbattimento acustico

Noise reduction

ΔL_w 24 dB

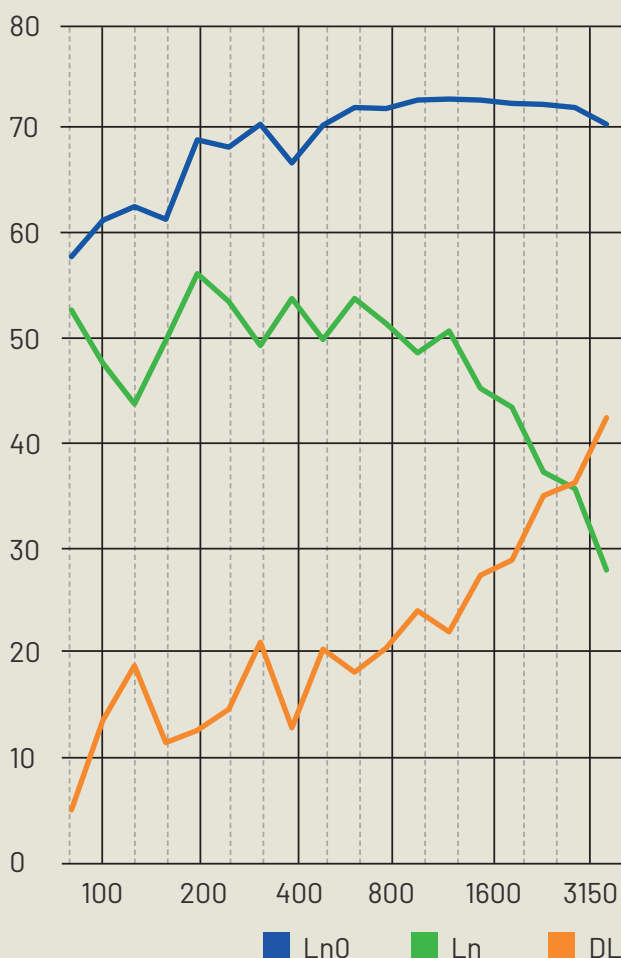

Identificazione delle norme di riferimento: EN ISO 10140-3: 2021
Acustica - misurazione in laboratorio dell'isolamento acustico di edifici e di elementi di edificio: misurazione dell'isolamento del rumore da calpestio.

Identification of reference standards: EN ISO 10140-3: 2021
Acoustics - Laboratory measurement of building and building element sound insulation: Measurement of impact sound insulation.

NM S New Maxi Silent

New Maxi Silent

Test di laboratorio effettuato su un solaio campione composto da getto unico in cls armato di sp. 140 mm, strato isolante espanso a celle chiuse, piastrelle in gres 60x60 cm, posate su NM3 in polipropilene e gomma. Il sistema garantisce un abbattimento acustico ΔL_w di 23 dB.

Laboratory test carried out on a sample floor composed of a single cast in reinforced concrete with a thickness of 140 mm, closed-cell foam insulation layer, 60x60 cm porcelain slabs laid on polypropylene and rubber NM3 supports. The system provides a sound reduction of 23 dB in terms of ΔL_w .



Strato isolante espanso modificato a celle chiuse ad alta densità, spessore 3 mm.
High-density, closed-cell, 3 mm thick foam insulating layer.

Abbattimento acustico Noise reduction

ΔL_w **23 dB**

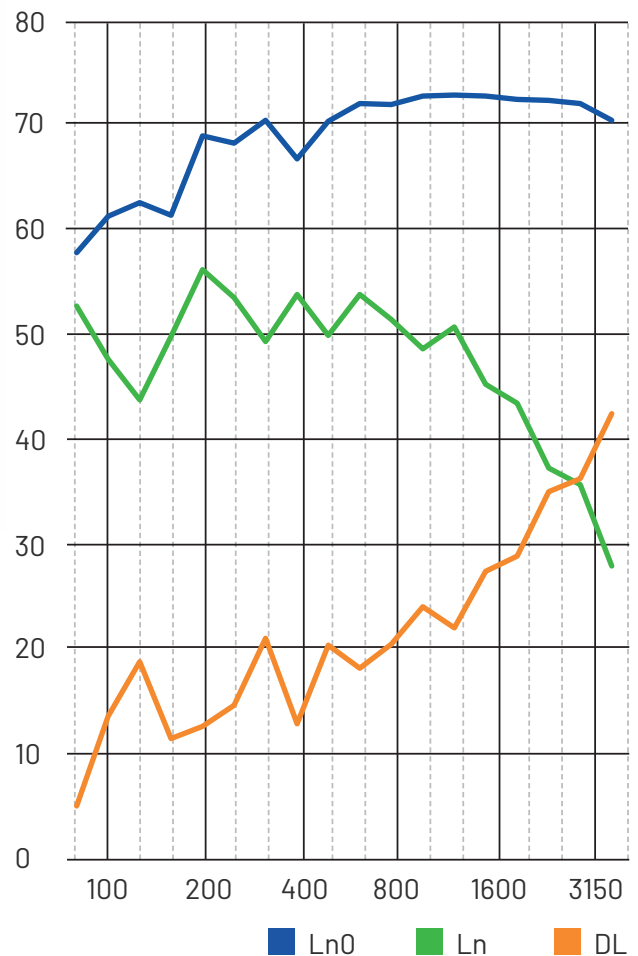



Identificazione delle norme di riferimento: EN ISO 10140-3: 2021
Acustica - misurazione in laboratorio dell'isolamento acustico di edifici e di elementi di edificio: misurazione dell'isolamento del rumore da calpestio.

Identification of reference standards: EN ISO 10140-3: 2021
Acoustics - Laboratory measurement of building and building element sound insulation: Measurement of impact sound insulation.

PR S

Sistema Pedestal Prime® PR S PR S Pedestal Prime® system



CODICE CODE	DESCRIZIONE DESCRIPTION	MISURA SIZE	PAG. LISTINO PRICE LIST PAGE	PZ 	PZ 	
					Italy	Abroad
E500030065.S	PR S 1	30-65 mm	36	25	1200	1350
E500060155.S	PR S 2	65-155 mm	36	25	600	750
E500150420.S	PR S 3	155-420 mm	36	12	288	336
E501000190	Prolunga PR* <i>PR Extension*</i>	-	36	12	-	

NB: I codici dei supporti si riferiscono al modello con testa autolivellante Ø 110 mm con alette spessore 4 mm H 12 mm, su richiesta 2-3 mm e liscia.

* Utilizzabile con PR3.



NB: The supports codes refer to type with self-leveling head Ø110 mm with 4 mm thick tabs, H 12 mm, on request also 2 - 3 mm and flat.

* Usable with PR3.

SR/SRT S

Sistema Reversus® SR/SRT S SR/SRT S Reversus® system



CODICE CODE	DESCRIZIONE DESCRIPTION	MISURA SIZE	PAG. LISTINO PRICE LIST PAGE	PZ 	PZ 	
					Italy	Abroad
E030020304.S	SR S 1	26-38 mm	37	20	1200	1320
E030020406.S	SR S 2	38-60 mm	37	20	840	960
E030020610.S	SR S 3	59-100 mm	37	20	600	720
E030020916.S	SR S 4	93-162 mm	37	20	480	480
E030021628.S	SR S 5	158-280 mm	37	20	360	420
E030010304.S	SRT S 1	26-38 mm	37	20	1200	1320
E030010406.S	SRT S 2	38-60 mm	37	20	840	960
E030010610.S	SRT S 3	59-100 mm	37	20	600	720
E030010916.S	SRT S 4	93-162 mm	37	20	480	480
E030011628.S	SRT S 5	158-280 mm	37	20	360	420
E044000145	Prolunga PNM <i>PNM Extension</i>	-	37	30	600	

NB: I codici dei supporti si riferiscono al modello con testa reversibile Ø 110 mm SR/SRT.



NB: The supports codes refer to type with SR/SRT reversible head Ø 110 mm.

SE S

Sistema Silent Eterno SE S

SE S Eterno Silent system



CODICE CODE	DESCRIZIONE DESCRIPTION	MISURA SIZE	PAG. LISTINO PRICE LIST PAGE	PZ 	PZ 
E350031041	SE S 0	31-41 mm	38	25	1500
E350040053	SE S 1	40,5-53 mm	38	25	1200
E350053078	SE S 2	53-78 mm	38	25	1200
E350078123	SE S 3	78-123 mm	38	25	800
E350123173	SE S 4	123-173 mm	38	25	600
E350173218	SE S 5	173-218 mm	38	25	600
E350143233	SE S 6	143-233 mm	38	-	-
E350188278	SE S 7	188-278 mm	38	-	-
E350238328	SE S 8	238-328 mm	38	-	-
E350208348	SE S 9	208-348 mm	38	-	-
E350253388	SE S 10	253-388 mm	38	-	-
E350303403	SE S 11	303-403 mm	38	-	-
E350273458	SE S 12	273-458 mm	38	-	-
E350318503	SE S 13	318-503 mm	38	-	-
E350368553	SE S 14	368-553 mm	38	-	-
E130125000	Prolunga P1* <i>P1 Extension*</i>	-	38	25	1050

NB: I codici dei supporti si riferiscono al modello con testa autolivellante Ø 110 mm con alette spessore 4 mm H 12 mm, su richiesta 2-3 mm e liscia.

* Prolunga utilizzabile solo con supporti da SES 3 a SES 5.

NB: The supports codes refer to type with self-leveling head Ø110 mm with 4 mm thick tabs, H 12 mm, on request also 2 - 3 mm and flat.



* Extension element suitable only to types from SES 3 to SES 5.

NM S

Sistema Silent New Maxi NM S

NM S New Maxi Silent system



CODICE CODE	DESCRIZIONE DESCRIPTION	MISURA SIZE	PAG. LISTINO PRICE LIST PAGE	PZ 	PZ 
E017018024	NM S 0	18-28 mm	39	20	1680
E017028044	NM S 1	28-43 mm	39	20	1320
E017043074	NM S 2	43-73 mm	39	20	960
E017063104	NM S 3	63-103 mm	39	20	720
E017093164	NM S 4	93-163 mm	39	20	600
E017153274	NM S 5	153-273 mm	39	20	420
E044000145	Prolunga PNM* <i>PNM Extension*</i>	-	39	30	600

NB: I codici dei supporti si riferiscono al modello con testa Ø 110 mm con alette spessore 4 mm H 12 mm, su richiesta 2-3 mm e liscia.

* Prolunga utilizzabile solo con supporti da NMS 3 a NMS 5.

NB: The supports codes refer to type with head Ø 110 mm with 4 mm thick tabs, H 12 mm, on request also 2 - 3 mm and flat.

* Extension element suitable only to types from NMS 3 to NMS 5.

SUPPORTI AUTOESTINGUENTI

VO SELF-EXTINGUISHING SUPPORTS



La protezione passiva al fuoco è la risposta indispensabile per limitare al massimo i danni in caso di incendio e preservare in questo modo l'incolumità degli abitanti.

Per questo Eterno Ivica, da sempre attenta al tema della sicurezza, ha messo a punto una gamma di prodotti con specifiche proprietà autoestinguenti.

Nascono così le linee di supporti Pedestal Autoestinguente VO, declinabili e utilizzabili per tutti i supporti PR, SE, NM, Star.T e EH della linea Pedestal. Sono le prime al mondo realizzate con materie prime autoestinguenti.

I supporti autoestinguenti, in caso di incendio, non permettono il propagarsi delle fiamme riducendo significativamente le esalazioni di fumo rispetto ai prodotti tradizionali.

Passive fire protection is the indispensable answer to minimize damage in the event of a fire and thus preserve the safety of inhabitants.

This is why Eterno Ivica, always attentive to the issue of safety, has developed a range of products with specific self-extinguishing properties.

This is how the self-extinguishing VO Pedestal supports, which can be declined and used for all PR, SE, NM, Star.T and EH supports were born. They are the first in the world made with self-extinguishing raw materials.

Self-extinguishing Pedestal supports, in case of fire, do not allow the spread of flames, significantly reducing smoke fumes compared to traditional products.

Scacco matto al fuoco! Checkmate to fire!



PR VO

Supporto Pedestal Prime®

autoestinguente

VO self-extinguishing



Pedestal Prime® support



PR VO

Supporto regolabile autolivellante
e basculante Pedestal Prime®
Pedestal Prime® adjustable
and self-levelling support



CODICE CODE	DESCRIZIONE DESCRIPTION	MISURA SIZE	PAG. LISTINO PRICE LIST PAGE	PZ 	PZ 
E500030065.VO	PR 1 VO	30-65 mm*	42	25	1350
E500060155.VO	PR 2 VO	65-155 mm*	42	25	750
E500150420.VO	PR 3 VO	155-420 mm*	42	12	336
E501000190.VO	Prolunga PR VO** <i>PR extension VO**</i>	-	42	12	576
E036000100.VO	Blocco testa basculante VO <i>Locking system for Prime® VO self levelling pedestal</i>	-	42	800***	-

* Le misure indicate si riferiscono a base + vite + prolunga
integrata + testa Ø 110 mm bi-componente autolivellante.

** Compatibile solo con PR3 VO.

*** In sacchetti da 100 pz.

* The measures indicated refer to base + screw + integrated
extension + head Ø 110 mm two-component self-levelling.

** Compatible with PR3 VO only.

*** Bags of 100 pcs.



Composizione grandi altezze Great heights composition

DESCRIZIONE DESCRIPTION	MISURA SIZE	UNIT 
PR 3 + 1 PR extension VO	310 - 595 mm	12 PR3 + 1 X 12 PR
PR 3 + 2 PR extensions VO	410 - 770 mm	12 PR3 + 2 X 12 PR
PR 3 + 3 PR extensions VO	515 - 945 mm	12 PR3 + 3 X 12 PR

SE VO

Supporto Eterno
autoestinguente
VO self-extinguishing
Eterno support



CODICE CODE	DESCRIZIONE DESCRIPTION	MISURA SIZE	PAG. LISTINO PRICE LIST PAGE	PZ 	PZ 
E240028038.VO	SE VO 0	28-38 mm	43	25	1500
E240037050.VO	SE VO 1	37,5-50 mm	43	25	1200
E240050075.VO	SE VO 2	50-75 mm	43	25	1200
E240075120.VO	SE VO 3	75-120 mm	43	25	800
E240120170.VO	SE VO 4	120-170 mm	43	25	600
E240170215.VO	SE VO 5	170-215 mm	43	25	600
E240140230.VO	SE VO 6	140-230 mm	43	-	-
E240185275.VO	SE VO 7	185-275 mm	43	-	-
E240235325.VO	SE VO 8	235-325 mm	43	-	-
E240205345.VO	SE VO 9	205-345 mm	43	-	-
E240250385.VO	SE VO 10	250-385 mm	43	-	-
E240300400.VO	SE VO 11	300-400 mm	43	-	-
E240270455.VO	SE VO 12	270-455 mm	43	-	-
E240315500.VO	SE VO 13	315-500 mm	43	-	-
E240365550.VO	SE VO 14	365-550 mm	43	-	-
E130125000.VO	Prolunga P1 VO* <i>P1 VO Extension*</i>	-	43	25	1050
E036000100.VO	Blocco testa basculante VO <i>Locking system VO</i>	-	43	800**	-

NB: I codici dei supporti si riferiscono al modello con testa autolivellante Ø 110mm con alette spessore 4 mm H 12 mm.

* Prolunga utilizzabile solo con supporti da SE VO 3 a SE VO 5.

*** In sacchetti da 100 pz.

NB: The supports codes refer to type with self-leveling head Ø 110 mm with 4 mm thick tabs, H 12 mm.



* Extension element suitable only to types from SE VO 3 to SE VO 5.

*** Bags of 100 pcs.

NM VO

Supporto New Maxi
autoestinguente
VO self-extinguishing
New Maxi support



CODICE CODE	DESCRIZIONE DESCRIPTION	MISURA SIZE	PAG. LISTINO PRICE LIST PAGE	PZ 	PZ 
E014015027.VO	NM VO 0	15-25 mm	44	20	1680
E014025047.VO	NM VO 1	25-40 mm	44	20	1320
E014040077.VO	NM VO 2	40-70 mm	44	20	960
E014060107.VO	NM VO 3	60-100 mm	44	20	720
E014090167.VO	NM VO 4	90-160 mm	44	20	600
E014150277.VO	NM VO 5	150-270 mm	44	20	420
E044000145.VO	Prolunga PNM VO* <i>PNM VO Extension*</i>	-	44	30	600

NB: I codici dei supporti si riferiscono al modello con testa \varnothing 110 mm con alette spessore 4 mm H 12 mm.

* Prolunga utilizzabile solo con supporti da NM VO 3 a NM VO 5.



NB: The supports codes refer to type with head \varnothing 110 mm with 4 mm thick tabs, H 12 mm.

* Extension element suitable only to types from NM VO 3 to NM VO 5.

ST VO

Supporto Star.T
 autoestinguente
 VO self-extinguishing
 Star.T support



CODICE CODE	DESCRIZIONE DESCRIPTION	MISURA SIZE	PAG. LISTINO PRICE LIST PAGE	PZ 	PZ 
E003011015.V0	Star.T ST VO - aletta 4 mm H 12 mm <i>ST VO Star.T - tabs 4 mm thick H 12 mm</i>	10-15 mm	45	100	5400
E003920005.V0	Prolunga Star.T ST VO <i>ST VO Star.T extension</i>	5 mm	45	200	10800

EH VO

Supporto EH
autoestinguente
VO self-extinguishing
EH support



CODICE CODE	DESCRIZIONE DESCRIPTION	SPESSORE ALETTE TABS THICKNESS	ALTEZZA ALETTE TABS HEIGHT	MISURA SIZE	PAG. LISTINO PRICE LIST PAGE	PZ 	PZ 
E008012008.VO	EH VO 12 - alette H 8 mm <i>EH VO 12 - tabs H 8 mm</i>	2,5	8	12 mm	45	250	5000
E000012003.VO	EH VO 12	3	11	12 mm	45	250	5000
E000015000.VO	EH VO 15	3	12	15 mm	45	200	4000
E002020000.VO	EH VO 20	4	18	20 mm	45	150	3000
E050005000.VO	Equilibratore VO <i>Balancer VO</i>	-	-	5 mm	45	3000 (sacchetti da 200pz.) <i>(bags of 200pcs.)</i>	-



SUPPORTI METALLICI

METAL SUPPORTS

CLASSE A1
A1 FIRE RATED



I supporti da esterno interamente in sicurezza in classe A1 di resistenza al fuoco. Resistenti, sicuri, versatili per garantire una posa semplice e veloce.

In risposta alle normative europee in materia di prevenzione degli incendi, Eterno Ivica ha introdotto i supporti metallici SMA e SMAT. Pensati per garantire l'integrità strutturale delle pavimentazioni nelle terrazze esterne in caso di incendio, con un range di altezze da 27 a 458 mm, garantiscono sicurezza e velocità di posa. Adatti per lastre, decking e posa multiformato.

External supports, fully secure, with a fire resistance classification of A1. Durable, safe, and versatile to ensure easy and fast installation.

In response to European regulations concerning fire prevention, Eterno Ivica has introduced the SMA and SMAT metal supports. Designed to ensure the structural integrity of outdoor terrace pavements in case of fire, with a range of heights from 27 to 458 mm, they provide both safety and quick installation. Suitable for slabs, decking, and multi-format installations.

SMA

CLASSE A1
A1 FIRE RATED

Supporto metallico SMA

Metal support SMA

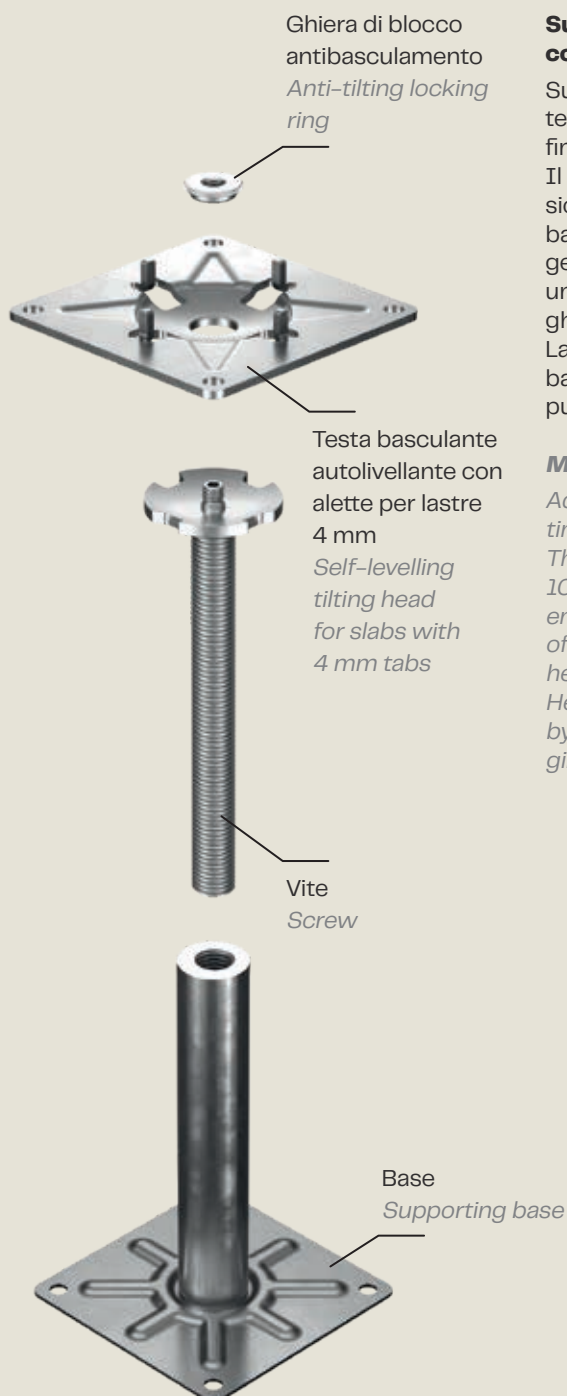

Supporto metallico SMA con testa autolivellante con alette per lastre

Supporto metallico per pavimentazioni sopraelevate regolabile in altezza, con testa basculante autolivellante che compensa la pendenza fino al 5%.

Il supporto è costituito da una base di appoggio quadrata delle dimensioni di 100 x 100 mm, spessore 1,8 mm e da una vite costituita da una barra filettata alla cui estremità è fissato un elemento concavo che funge da sede di appoggio della testa basculante. Completa il supporto una testa autolivellante basculante con alette per fughe da 4 mm e una ghiera di blocco antibasculamento.

La regolazione in altezza viene effettuata manualmente agendo sulla barra filettata oppure tramite la chiave a brugola da 4 mm, il supporto può raggiungere altezze variabili da 27 mm a 458 mm.

Metal support SMA with self-levelling head with tabs for slabs

Adjustable metal support for elevated flooring, with self-levelling tilting head that compensates slopes up to 5%.

The support consists of a square support base of dimensions of 100 x 100 mm, 1.8 mm thick, and a screw consisting of a threaded bar at the end of which is fixed a concave element that acts as the support seat of the tilting head. The support is completed by a self-levelling tilting head with 4 mm tabs and an anti-tilting locking ring.

Height adjustment is done manually by acting on the threaded bar or by means of the 4 mm Allen key; the support can reach heights ranging from 27 mm to 458 mm.



Guarda il video di presentazione



Watch the presentation video

SMA

Supporto metallico SMA

Metal support SMA



CODICE CODE	DESCRIZIONE DESCRIPTION	MISURA SIZE	PAG. LISTINO PRICE LIST PAGE	PZ 	PZ 
T0001028035	SMA 1 con testa per lastre - alette 4 mm H 12 mm <i>SMA 1 with head for slabs - tab 4 mm H 12 mm</i>	27-35 mm	48	50	-
T0001034046	SMA 2 con testa per lastre - alette 4 mm H 12 mm <i>SMA 2 with head for slabs - tab 4 mm H 12 mm</i>	34-46 mm	48	50	-
T0001044062	SMA 3 con testa per lastre - alette 4 mm H 12 mm <i>SMA 3 with head for slabs - tab 4 mm H 12 mm</i>	44-62 mm	48	25	-
T0001061097	SMA 4 con testa per lastre - alette 4 mm H 12 mm <i>SMA 4 with head for slabs - tab 4 mm H 12 mm</i>	61-97 mm	48	25	-
T0001095165	SMA 5 con testa per lastre - alette 4 mm H 12 mm <i>SMA 5 with head for slabs - tab 4 mm H 12 mm</i>	95-165 mm	48	25	-
T0001163300	SMA 6 con testa per lastre - alette 4 mm H 12 mm <i>SMA 6 with head for slabs - tab 4 mm H 12 mm</i>	163-300 mm	48	20	-
T0001298458	SMA 7 con testa per lastre - alette 4 mm H 12 mm <i>SMA 7 with head for slabs - tab 4 mm H 12 mm</i>	298-458 mm	48	10	-

Composizione altezze

Height composition

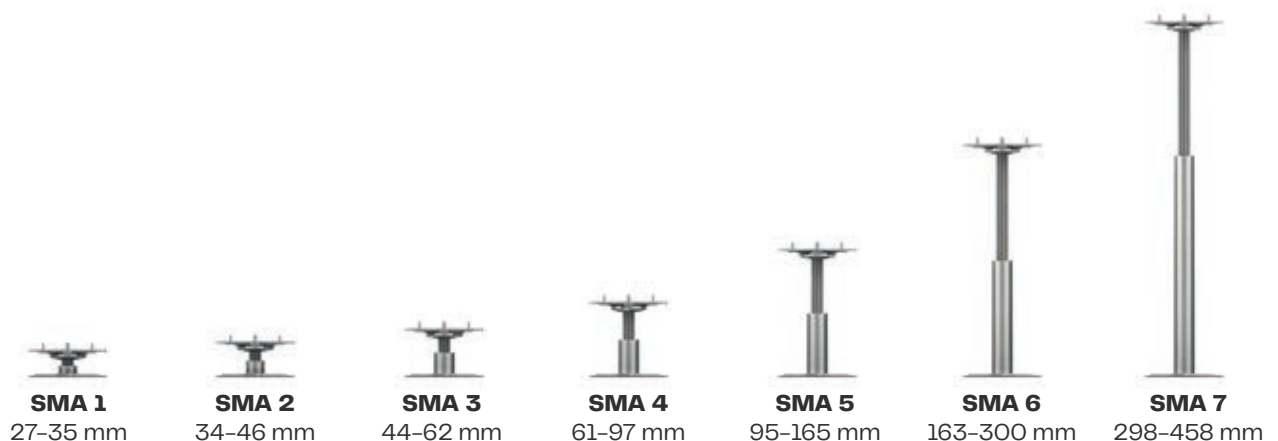

SMAT

CLASSE A1

A1 FIRE RATED

Supporto metallico SMAT

Metal support SMAT

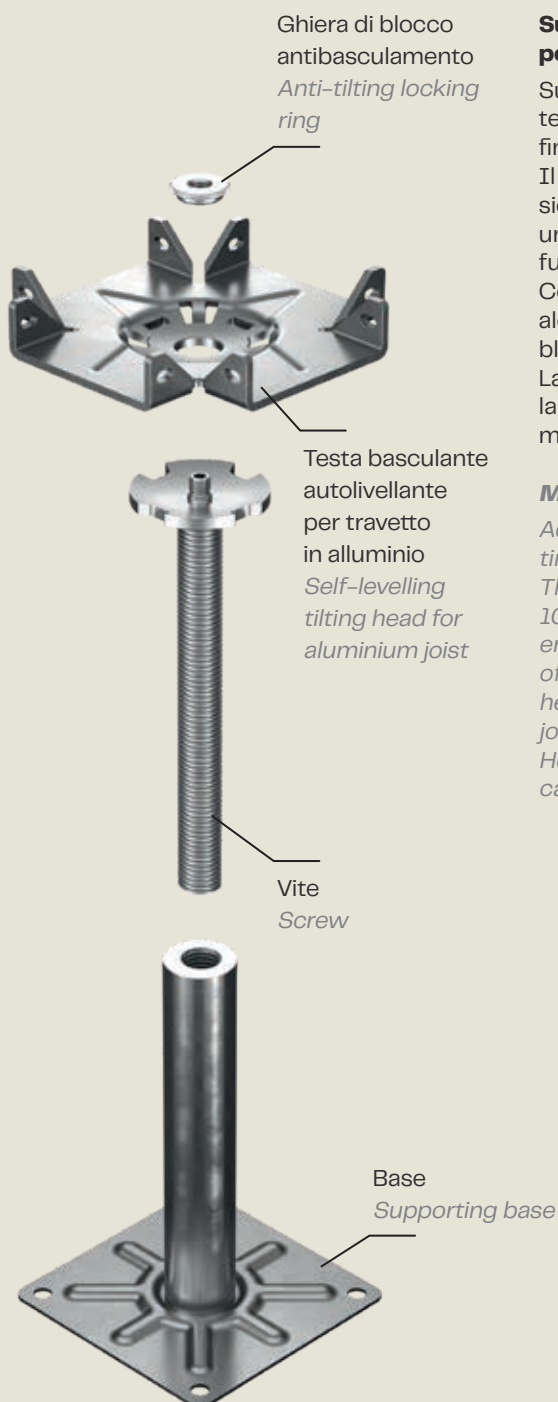

Supporto metallico SMAT con testa autolivellante per travetto in alluminio

Supporto metallico per pavimentazioni sopraelevate regolabile in altezza, con testa basculante autolivellante che compensa la pendenza fino al 5%.

Il supporto è costituito da una base di appoggio quadrata delle dimensioni di 100 x 100 mm, spessore 1,8 mm e da una vite costituita da una barra filettata alla cui estremità è fissato un elemento concavo che funge da sede di appoggio della testa basculante.

Completa il supporto una testa autolivellante basculante con apposite alette forate per l'inserimento e il fissaggio dei travetti e una ghiera di blocco antibasculamento.

La regolazione in altezza viene effettuata manualmente agendo sulla base, il supporto può raggiungere altezze variabili da 27 mm a 458 mm.

Metal support SMAT with self-levelling head for aluminium joist

Adjustable metal support for elevated flooring, with self-levelling tilting head that compensates slopes up to 5%.

The support consists of a square support base of dimensions of 100 x 100 mm, 1.8 mm thick, and a screw consisting of a threaded bar at the end of which is fixed a concave element that acts as the support seat of the tilting head. The support is completed by a self-levelling tilting head with special perforated tabs for the insertion and fixing of the joists, and an anti-tilting locking ring.

Height adjustment is done manually by acting on the base; the support can reach heights ranging from 27 mm to 458 mm.



Guarda il video di presentazione





Watch the presentation video

SMAT

Supporto metallico SMAT Metal support SMAT



CODICE CODE	DESCRIZIONE DESCRIPTION	MISURA SIZE	PAG. LISTINO PRICE LIST PAGE	PZ 	PZ 
T0005028035	SMAT 1 Testa per travetto <i>SMAT 1 Head for joist</i>	27-35 mm	49	50	-
T0005034046	SMAT 2 Testa per travetto <i>SMAT 2 Head for joist</i>	34-46 mm	49	50	-
T0005044062	SMAT 3 Testa per travetto <i>SMAT 3 Head for joist</i>	44-62 mm	49	25	-
T0005061097	SMAT 4 Testa per travetto <i>SMAT 4 Head for joist</i>	61-97 mm	49	25	-
T0005095165	SMAT 5 Testa per travetto <i>SMAT 5 Head for joist</i>	95-165 mm	49	25	-
T0005163300	SMAT 6 Testa per travetto <i>SMAT 6 Head for joist</i>	163-300 mm	49	20	-
T0005298458	SMAT 7 Testa per travetto <i>SMAT 7 Head for joist</i>	298-458 mm	49	10	-

Composizione altezze

Height composition



SMAT 1
27-35 mm



SMAT 2
34-46 mm



SMAT 3
44-62 mm



SMAT 4
61-97 mm



SMAT 5
95-165 mm



SMAT 6
163-300 mm



SMAT 7
298-458 mm

Strato separatore in acciaio zincato classe A1



Galvanized steel separator layer A1 fire rated



Lo strato separatore in acciaio zincato è costituito da una lastra in lamiera zincata dello spessore di 1 mm e dimensioni di 184x184 mm, viene applicato sotto la base dei supporti metallici al fine di proteggere il manto impermeabile dai supporti della pavimentazione sopraelevata.

La sua speciale forma consente di appoggiare il supporto al centro della lastra nel caso di posa libera (al centro della terrazza) o nell'angolo della lastra (nel caso di posa contro parete e/o negli angoli). La particolare forma gli consente di non essere "tagliato" o "modificato" in nessun caso. Il bordo della faccia inferiore ha un raggio che assicura di non danneggiare il sottostante manto impermeabile, inoltre è garantita la perfetta evacuazione dell'acqua piovana.

The supplementary galvanized steel base layer consists of a galvanized sheet plate 1 mm thick and 184x184 mm in size, it is applied under the base of the metal supports in order to protect the waterproof covering from the supports of the raised floor.

Its special shape allows the support to be placed at the center of the plate in the case of free-standing installation (at the center of the terrace), or in the corner of the plate (in the case of installation against the wall and/or in the corners). Its special shape makes it so that it does not need to be "cut" or "modified" ever. The edge of the lower face has a radius that ensures that the underlying waterproof covering is not damaged, and the perfect evacuation of rainwater is also guaranteed.

CODICE CODE	DESCRIZIONE DESCRIPTION	MISURA SIZE	PAG. LISTINO PRICE LIST PAGE	PZ
T0000003419	Strato separatore in acciaio zincato <i>Galvanized steel separator layer</i>	184 x 184 mm	49	25

CLASSE A1
A1 FIRE RATED



Posizione al centro
Center position

Posizione a bordo parete o angolo
Wall or corner position

Vantaggi

- Protegge il manto impermeabile dalla posa dei supporti di pavimentazione
- È utilizzabile in tutte le situazioni di posa senza bisogno di eseguire “tagli” e/o “modifiche”

Advantages

- *It protects the waterproof covering from laying the flooring supports*
- *It can be used in all laying scenarios with no need to perform “cuts” and/or “modifications”*

ACCESSORI

ACCESSORIES



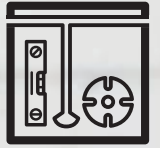
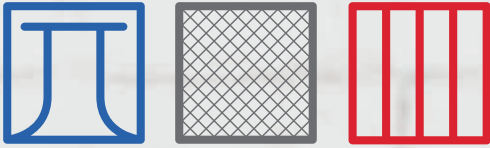

La gamma completa di accessori per pavimentazioni so-praelevate realizzate a regola d'arte.
Eterno Ivica offre un'ampia gamma di accessori comple-mentari a tutte le linee di supporti pensati e realizzati per soddisfare ogni tipo di esigenza.

The complete range of accessories for raised floors made to perfection.

Eterno Ivica offers a wide range of complementary ac-cessories to all lines of supports designed and manu-factured to meet every need.





Chiave di regolazione per la rimozione rapida e sicura delle alette e accessorio per avvitatore
Adjustment key for quick and sure removal of the tabs and screwdriver accessory



Particolare dell'accessorio per avvitatore in acciaio per "svitamento e avvitamento rapido".
 Detail of the steel screwdriver accessory for "quick unscrewing and screwing".



Il nuovo dettaglio per la rimozione sicura e rapida delle alette.
 New detail for safe and quick removal of the tabs.

I supporti regolabili Pedestal, offrono molteplici soluzioni per compensare piccole imperfezioni e grandi pendenze di qualsiasi piano di posa così da realizzare sempre pavimentazioni perfettamente stabili e piane. L'esclusiva chiave di regolazione, elemento essenziale del sistema, permette la regolazione dei supporti (e conseguentemente del pavimento soprastante) anche a pavimento finito evitando pertanto di doverlo sollevare.

The Pedestal adjustable supports, offer multiple solutions to compensate for small imperfections and large gradients of any laying surface so as to always achieve a very stable and perfectly flat floor. The unique adjustment key, an essential element of the system also allows to adjust the height of the supports (and consequently the floor above) even with a finished floor thus avoiding having to lift the slab.

CODICE CODE	DESCRIZIONE DESCRIPTION	PAG. LISTINO PRICE LIST PAGE	PZ 	PZ 
E200250120	Chiave di regolazione* Adjustment key*	52	-	-
E200250130	Accessorio per avvitatore Screwdriver accessory	52	-	-

* Utilizzabile solo con alette spessore 4mm.

* Suitable only with standard 4mm thick tabs.

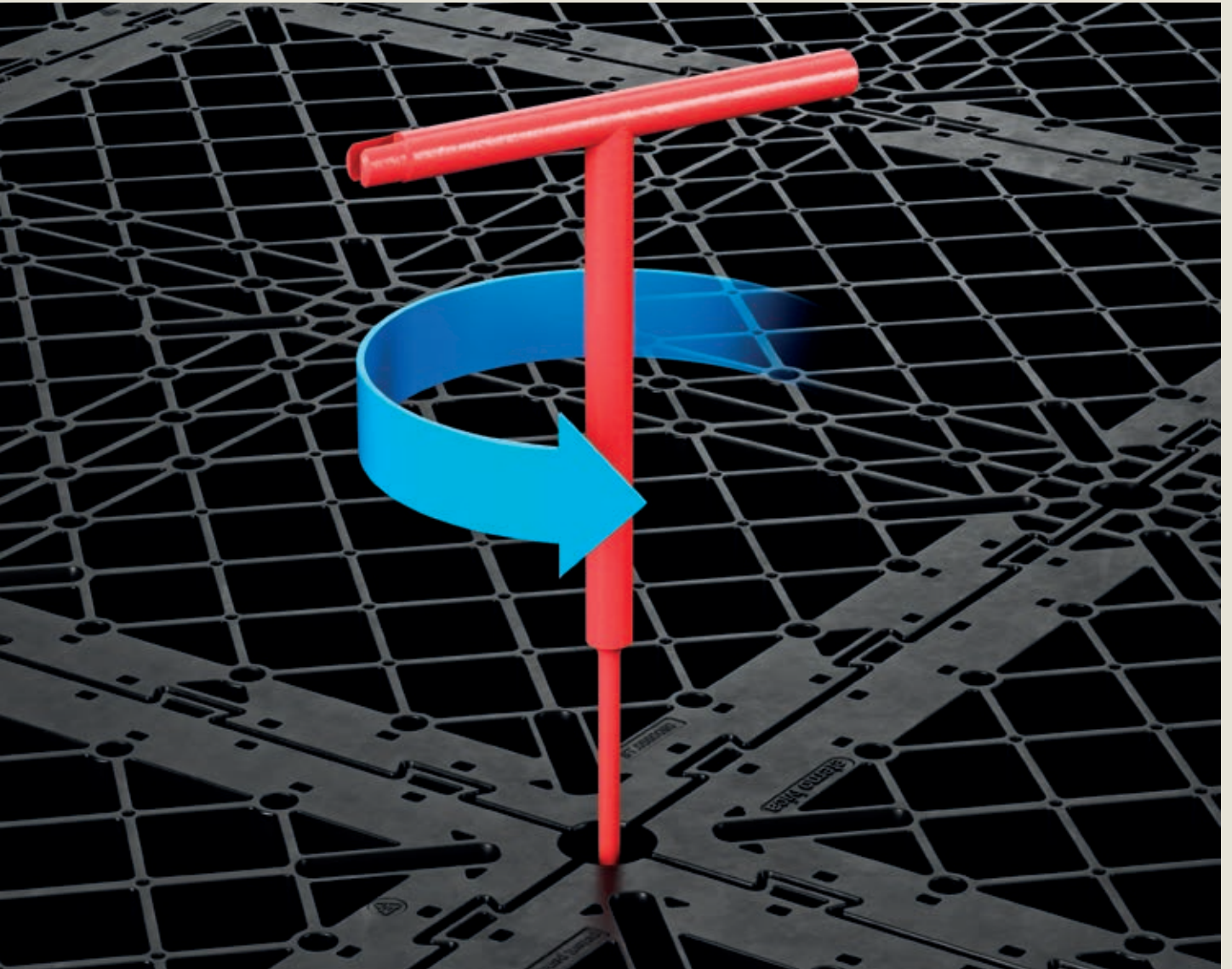

Maniglia posa lastre

Slab lifting handle

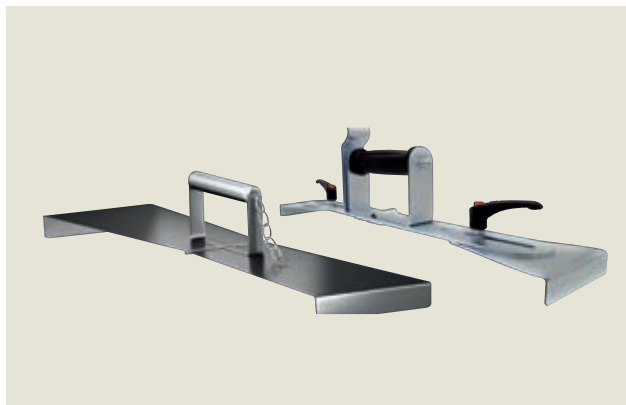

La maniglia posa lastre è disponibile in due versioni, una regolabile da 380 a 620 mm e una più semplice con misure fissa da 400, 500 o 600 mm.

La maniglia è provvista di due agganci laterali che si inseriscono tra le fughe e consentono di poter sollevare anche lastre già posate.

The slab lifting handle is available in two versions: one is adjustable from 380 to 620 mm, and another simpler one for standard sizes from 400, 500 or 600 mm.

The handle is provided with two lateral hooks that are inserted into the joints and allow to lift also the already laid slabs. It is a very useful tool both when laying new floors and when lifting already laid slabs.

Ventosa alza lastra

Suction cup slab lifter



La ventosa alza lastra vacuum a pompa è una soluzione innovativa per la movimentazione di lastre di ceramica, grazie alla placca in gomma, del diametro di 200 mm, garantisce un'ottima presa.

Grazie alla sua guarnizione laterale, è perfettamente adattabile e fa presa su qualsiasi superficie, liscia o ruvida, per un risultato assicurato.

La ventosa ha una portata massima di 110 Kg.

The vacuum suction cup slab lifter is an innovative solution for handling ceramic slabs; thanks to the rubber plate, with a diameter of 200 mm, it guarantees excellent grip. Thanks to its side seal, it is perfectly adaptable and it grips on any surface, smooth or rough, for a guaranteed result.

The suction cup has a maximum capacity of 110 kg.

CODICE CODE	DESCRIZIONE DESCRIPTION	MISURA SIZE	PAG. LISTINO PRICE LIST PAGE	PZ 
M030004060	Maniglia posa lastre <i>Slab lifting handle</i>	da 380 mm a 620 mm <i>from 380 mm to 620 mm</i>	52	-
M030400400		400 mm	52	-
M030500500		500 mm	52	-
M030600600		600 mm	52	-
M030100100		Ventosa alza lastra <i>Suction cup slab lifter</i>	Ø 200 mm	53

Alza lastra Slab lifter

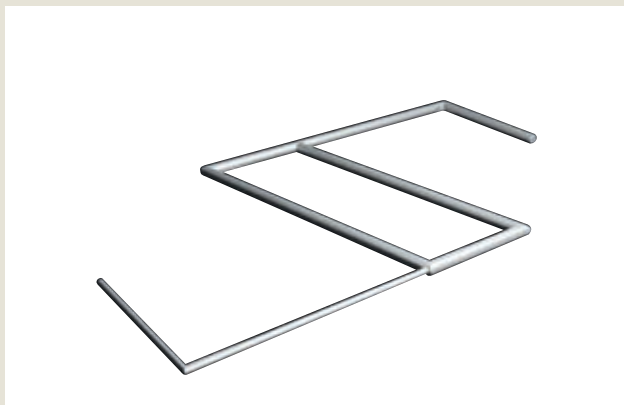

È un utensile indispensabile nel caso si voglia rimuovere o spostare una lastra di pavimentazione già posata. Ha la possibilità di infilarsi nelle fughe da 2-3-4 mm, semplice da impugnare e utilizzare. È sufficiente infilare l'utensile nella fuga e ruotarlo di 90°, a questo punto con poco sforzo si alza la lastra.

It is an essential tool if you want to remove or move an already laid flooring slab. It has the possibility of slipping into the 2-3-4 mm joints, it is easy to hold and use. It is sufficient to insert the tool into the joint and rotate it 90°, at this stage the slab is raised with little effort.

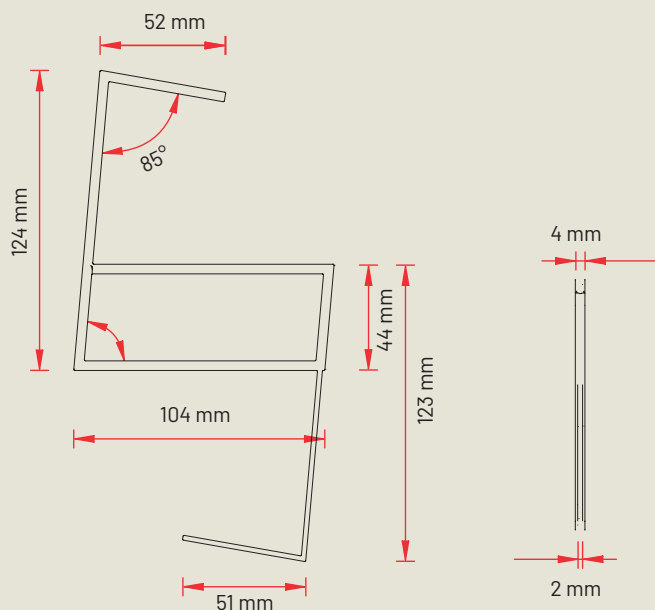

CODICE CODE	DESCRIZIONE DESCRIPTION	MISURA SIZE	PAG. LISTINO PRICE LIST PAGE	PZ 
M030000100	Alza lastra in ACCIAIO INOX per fughe da 2-3-4 mm <i>Stainless steel slab lifter for 2 - 3 - 4 mm joints</i>	Per fughe da 2 - 3 - 4 mm <i>For 2 - 3 - 4 mm joints</i>	53	-



Distanziatore perimetrale

Perimeter spacer



Chiave di regolazione sempre utilizzabile
Adjusting key always ready to use

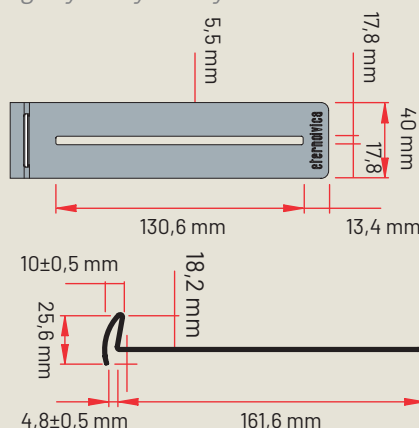

Il distanziatore perimetrale consente di distanziare in modo elegante e uniforme le lastre di pavimentazione dalle pareti perimetrali offrendo la massima garanzia di stabilità, mediante un sistema di aggancio ai supporti che si dimostra intuitivo, semplice ed efficace. La clip crea una fuga di 1 cm fra la pavimentazione e la parete offrendo lo spazio per il fisiologico assestamento delle lastre. La speciale conformazione della clip consente l'appoggio a eventuali guaine poste in verticale sulle pareti senza comprometterne la tenuta con ancoraggi invasivi e, al tempo stesso, permette di regolarne la posizione sulla testa del supporto in base alle esigenze di posizionamento dello stesso rispetto al bordo.

The perimeter spacers allow the elegant and uniform spacing of the paving slabs from the perimeter walls offering the maximum guarantee of stability by means of a hooking system to the supports that proves to be intuitive simple and effective. The clip creates a 1 cm joint between the flooring and the wall offering space for physiological stabilization of the slabs. The special design of the clip allows the support to any vertical sheaths placed on the walls without compromising the seal with invasive berths and, at the same time, allows to adjust its position on the support head according to the positioning requirements of the same with respect to the edge.

CODICE CODE	DESCRIZIONE DESCRIPTION	MATERIALE MATERIAL	ALTEZZA HEIGHT	LUNGHEZZA LENGHT	PAG. LISTINO PRICE LIST PAGE	PZ 
P021000220	Distanziatore perimetrale <i>Perimeter spacer</i>	Acciaio inox <i>Stainless steel</i>	25,6 mm	161,6 mm	53	100
P021000230	Distanziatore perimetrale <i>Perimeter spacer</i>	Polipropilene PP <i>Polypropylene PP</i>	25,6 mm	161,6 mm	53	200

Dettagli tecnici

Technical details



La clip può essere appoggiata sulla guaina isolante preservandone le prestazioni.
The clip can be placed on the insulating membrane preserving performance.



La clip distanzia di 1 cm la lastra dalla parete.
The clip distances 1 cm the slab from the wall.



Entrambi i distanziatori sono utilizzabili con tutti i sistemi di posa Eterno Ivica.
Both spacers can be used with all Eterno Ivica installation systems.



Possibilità di utilizzare il distanziatore con la base del supporto intera o tagliata.
It is possible to use the clip with the entire base or a cut base.



Scudo Scudo separating layer



Scudo è uno strato isolante espanso modificato a celle chiuse ad alta densità di 3 mm di spessore. Applicato sotto la base del supporto ha la funzione di strato separatore, protegge il manto impermeabile dai supporti di pavimentazione, inoltre diminuisce il ponte acustico che si crea tra pavimento e piano di posa evitando il ripercuotersi del rumore da calpestio.

Scudo is a 3 mm thick high density modified closed cell expanded insulating layer. Applied under the base of the support, it has the function of a separating layer, it protects the waterproof covering from flooring supports and it decreases the acoustic bridge that is created between the floor and the laying surface, avoiding the transmission of the impact noise.



Vantaggi

- Protegge il manto impermeabile dalla posa dei supporti di pavimentazione;
- Diminuisce il ponte acustico tra pavimento e piano di posa;
- A disposizione in due versioni: adesivo e non adesivo.

Advantages

- *It protects the waterproof covering from the laying of flooring support;*
- *It decreases the acoustic bridge between the floor and the laying surface;*
- *It is available in two versions: adhesive and non-adhesive.*

CODICE CODE	DESCRIZIONE DESCRIPTION	MISURA SIZE	PAG. LISTINO PRICE LIST PAGE	PZ 
E083000233	Spessore 3 mm adesivo <i>3 mm thickness adhesive</i>	Ø 205 mm	54	400
E083000223	Spessore 3 mm <i>3 mm thickness</i>	Ø 205 mm	54	400



Strato Separatore in gomma Supplementary rubber base



Lo strato separatore in gomma termoplastica (TPE) viene applicato sotto la base dei supporti, della pavimentazione sopraelevata, al fine di proteggere il manto impermeabile, inoltre diminuisce il ponte acustico che si crea tra pavimento e piano di posa evitando il ripercuotersi del rumore da calpestio.

Nella faccia inferiore sono indicate le linee di taglio in caso di necessità e il bordo in rilievo è fatto in modo che ci sia sempre una perfetta evacuazione dell'acqua piovana. Ha uno spessore di 2 mm e un diametro di 215 mm.

The supplementary rubber base in thermoplastic rubber (TPE) is applied under the base of the pedestals and its function is to protect the waterproofing membrane from the supports of the raised flooring. It also decreases the acoustic impact created between the floor and the laying surface, creating a conduction barrier for impact sound. The bottom side of the base shows cutting lines if needed, and the raised edge allows an easy outflow of rainwater. Thickness is 2 mm and diameter is 215 mm.



Vantaggi

- Protegge il manto impermeabile dalla posa dei supporti di pavimentazione;
- Diminuisce il ponte acustico tra pavimento e piano di posa.

Advantages

- *It protects the waterproofing membrane from the flooring supports,*
- *It decreases the acoustic impact between the floor and the laying surface.*

CODICE CODE	DESCRIZIONE DESCRIPTION	MISURA SIZE	PAG. LISTINO PRICE LIST PAGE	PZ
E083000300	Strato separatore in gomma <i>Supplementary rubber base</i>	Ø 215 mm	54	50



**Base
di cemento**
**Concrete
base**



La base di cemento viene utilizzata per migliorare la stabilità del sistema nel caso di posa su una superficie drenante, ad esempio ghiaia, viene posizionata tra la ghiaia ed il supporto avendo cura di verificare la planarità e la quota, mediante una livella a bolla o a laser. Misura 25 x 25 cm x H 6 cm. Per migliorare l'acustica e la stabilità si possono utilizzare, tra la base di cemento ed il supporto, lo "strato separatore in gomma" o lo "Scudo".

The concrete base is used to improve the stability of the system when installing it on a draining surface, such as gravel. It is placed between the gravel and the support, ensuring that the surface is level and properly aligned using a bubble or laser level. The dimensions of the cement base are 25 cm x 25 cm x 6 cm (height). To enhance acoustic performance and stability, you can use a rubber separation layer or the "Scudo" between the concrete base and the support.



CODICE CODE	DESCRIZIONE DESCRIPTION	MISURA SIZE	PAG. LISTINO PRICE LIST PAGE	PZ 
V13056600	Base di cemento <i>Concrete base</i>	25x25 cm H 6 cm	54	200



Livellatore per la posa delle piastrelle incollate

Slab leveling system for laying of the tiles glued

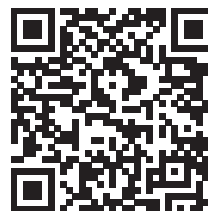

Guarda il video di presentazione



Watch the presentation video





Livellatore per la posa delle piastrelle incollate

Slab leveling system for laying of the tiles glued

Il livellatore per piastrelle è un elemento indispensabile per la posa in opera di pavimenti e rivestimenti in gres porcellanato ed è costituito da tre elementi: tirante, distanziatore e anello di protezione.

La parte cilindrica chiamata "tirante" si innesta nel "distanziatore" avvitandosi e facendo pressione sulle piastrelle: in questo modo i bordi delle piastrelle stesse si allineano e mantengono la perfetta planarità.

Questo sistema è dotato anche di una parte inferiore, svincolata dal tirante, chiamato "anello di protezione", il quale si appoggia alle piastrelle e fa in modo che il tirante avvitandosi non vada a segnare la piastrella.

The leveler for slabs is an indispensable tool for the installation of porcelain stoneware floors and walls and it consists of three elements: a tie rod, a spacer and a protection ring.

The cylindrical part called "tie rod" is inserted in the "spacer" by screwing and pressing on the slabs: in this way the edges of the slabs are aligned and maintain a perfect flatness. This system is also equipped with a lower part, released from the tie rod, called "protection ring", which rests on the slabs and ensures that the tie rod does not mark the slab when screwed.

Tirante
Tie rod

Anello di protezione
Protection ring

Distanziatore
Spacer

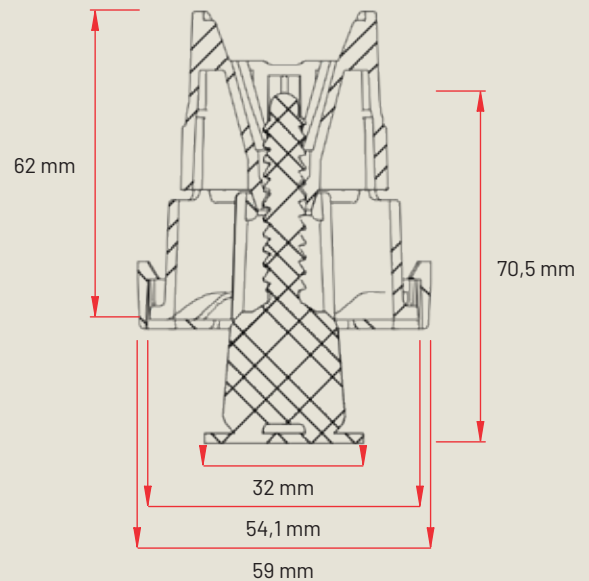
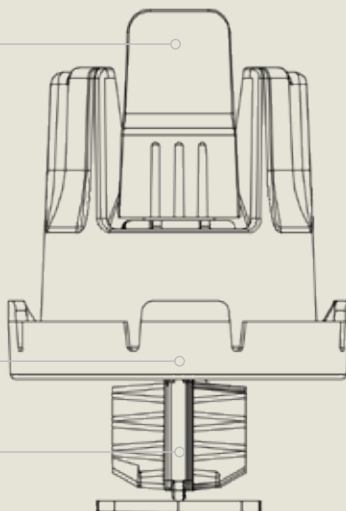

Il distanziatore determina lo spessore della fuga, che potrà essere di 1,5 – 2 – 3 – 4 – 5 mm nelle seguenti varianti: **“lineare”, a “T” e a “croce”**, da utilizzare in base al formato della piastrella e la tipologia di posa che si intende creare.

Il distanziatore lineare è indicato per la posa di piastrelle di grande formato. Per esempio, il consumo a mq per la misura 60x60 cm è di 11 distanziatori.

Il distanziatore a **“T”** è indicato per la posa di piastrelle in modo sfalsato. Per esempio, il consumo a mq per la misura 15x60 cm è di 33 distanziatori.

Il distanziatore a **“croce”** è indicato per la posa di piastrelle di piccole dimensioni. Per esempio, il consumo a mq per la misura 30x30 cm è di 44 distanziatori.

Una volta che la colla ha fatto presa, si potrà rimuovere il tirante in modo semplice e veloce, il distanziatore a perdere si spezzerà in due parti e si svincolerà facilmente dal tirante.

The spacer determines the thickness of the joint, which can be 1,5 – 2 – 3 – 4 – 5 mm in the following variants: **“linear”, “T” and “cross”**, to be used according to the size of the tile and the type of installation to be created.

The **“linear”** spacer is suitable for laying large format tiles. For example, the consumption per square meter for the 60x60 cm size is 11 spacers.

The **“T”** spacer is suitable for laying tiles in a staggered way. For example, the consumption per square meter for the 15x60 cm size is 33 spacers.

The **“cross”** spacer is suitable for laying small tiles. For example, the consumption per square meter for the 30x30 cm size is 44 spacers.

Once the glue has set, the tie rod can be removed quickly and easily, the disposable spacer will break into two parts and easily release from the tie rod.

CODICE CODE	DESCRIZIONE DESCRIPTION	MISURA SIZE	PAG. LISTI- NO PRICE LIST PAGE	 PZ	 PZ
E085000000	Tirante + anello di protezione <i>Tie-rod + protection ring</i>	-	55	50	5500
E085000100	Distanziatore lineare <i>Linear spacer</i>	1,5 mm	55	250	37500
E085000102		2 mm	55		
E085000103		3 mm	55		
E085000104		4 mm	55		
E085000105		5 mm	55		
E085000110	Distanziatore a “T” <i>“T” spacer</i>	1,5 mm	55	250	37500
E085000112		2 mm	55		
E085000113		3 mm	55		
E085000114		4 mm	55		
E085000115		5 mm	55		
E085000120	Distanziatore a croce <i>Cross spacer</i>	1,5 mm	55	250	37500
E085000122		2 mm	55		
E085000123		3 mm	55		
E085000124		4 mm	55		
E085000125		5 mm	55		

Tabella di consumo dei distanziatori Consumption of spacers

Esempio: piastrella 60 cm (A) x 30 cm (B)
22 pz./m²

Example: tile 60 cm (A) x 30 cm (B)
22 pcs./m²

A (cm)															
10	200														
15	133	89													
20	100	67	50												
25	80	53	40	32											
30	100	67	50	40	44										
33	91	61	45	36	40	37									
40	75	50	37	30	33	30	25								
45	67	44	33	27	30	27	22	20							
50	60	40	30	24	27	24	20	18	16						
60	50	33	25	20	22	20	17	15	13	11					
80	50	33	25	20	21	19	16	14	12	10	9				
90	44	30	22	18	19	17	14	12	11	9	8	7			
100	50	33	25	20	20	18	15	13	12	10	9	8	8		
120	42	28	21	17	17	15	13	11	10	8	7	6	7	6	
	10	15	20	25	30	33	40	45	50	60	80	90	100	120	B (cm)



PEDESTAL SYSTEM



Posa di pavimentazioni
sopraelevate direttamente
sui supporti

Laying raised floor directly
on the supports





Perché utilizzare Pedestal System?

Why use Pedestal System?

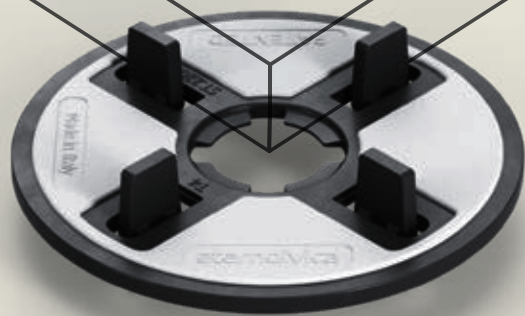

La lastra di ceramica si appoggia semplicemente sulla testa dei supporti precedentemente predisposti e livellati
The ceramic slab is simply placed on top of the pre-arranged and leveled supports

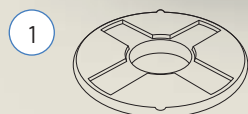

1
 Angolo muro
At the corner

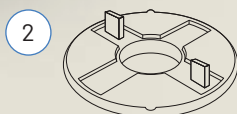

2
 Bordo muro
Along the wall

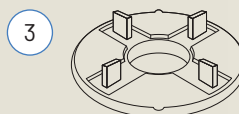

3
 Centro pavimento
In the middle

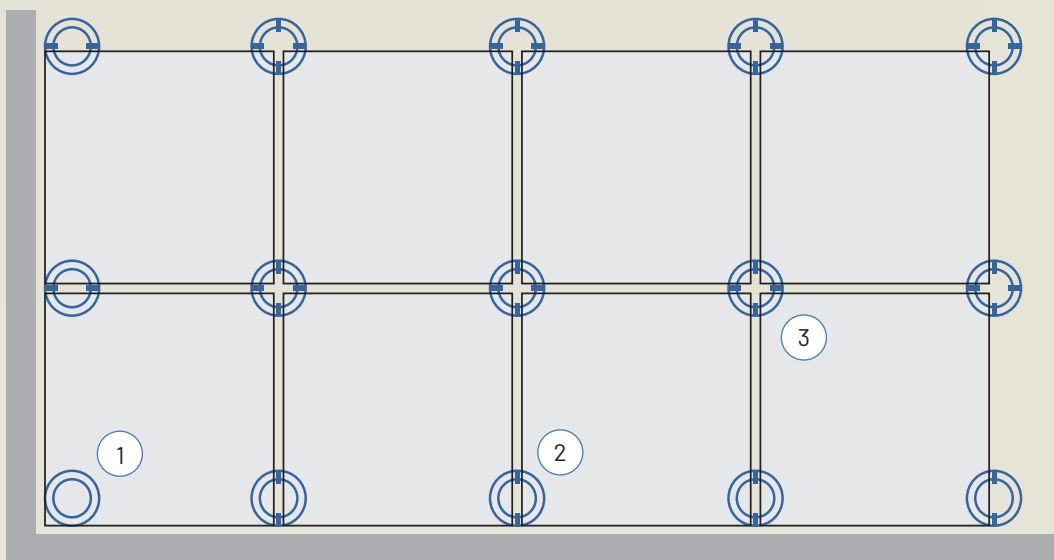

La posa piÙ rapida per una soluzione semplice ed elegante

The fastest installation method for a simple and elegant solution



Flessibilità, semplicità e rapidità nel processo di posa
Flexibility, simplicity, and speed in the installation process.



Semplicità di rimozione e possibilità di installazioni temporanee
Ease of removal and the ability to perform temporary installations



Protezione del manto impermeabile
Protection of the waterproofing layer

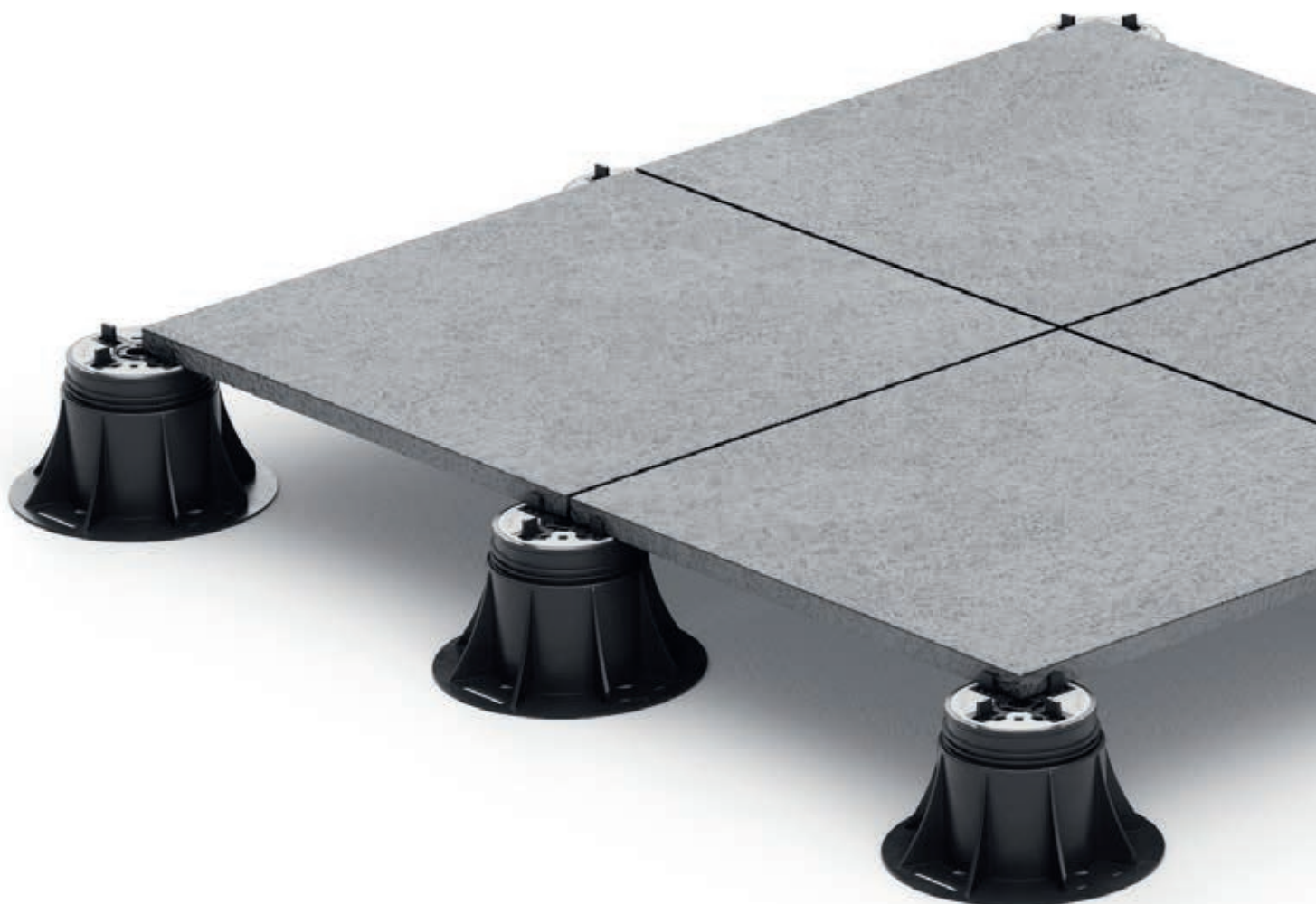

Gli elementi del sistema Pedestal

The elements of Pedestal System

I pavimenti sopraelevati con il sistema Pedestal sono realizzati con lastre in ceramica, cemento o pietra al naturale. Diversamente dal decking, per posare questi pavimenti è necessario semplicemente utilizzare i supporti (fissi o regolabili) per compensare le varie altezze dalla base al piano sopraelevato di calpestio. Sopra i supporti vengono appoggiate direttamente le lastre ed il pavimento è pronto per essere utilizzato: non è necessaria alcuna struttura di supporto.

Floors raised with the Pedestal system are made using ceramic, concrete, or natural stone slabs. Unlike decking, to install these floors, you only need to use fixed or adjustable supports to compensate for height differences from the base to the elevated floor level. The slabs are placed directly on the supports, and the floor is ready to be used - no additional support structure is required.

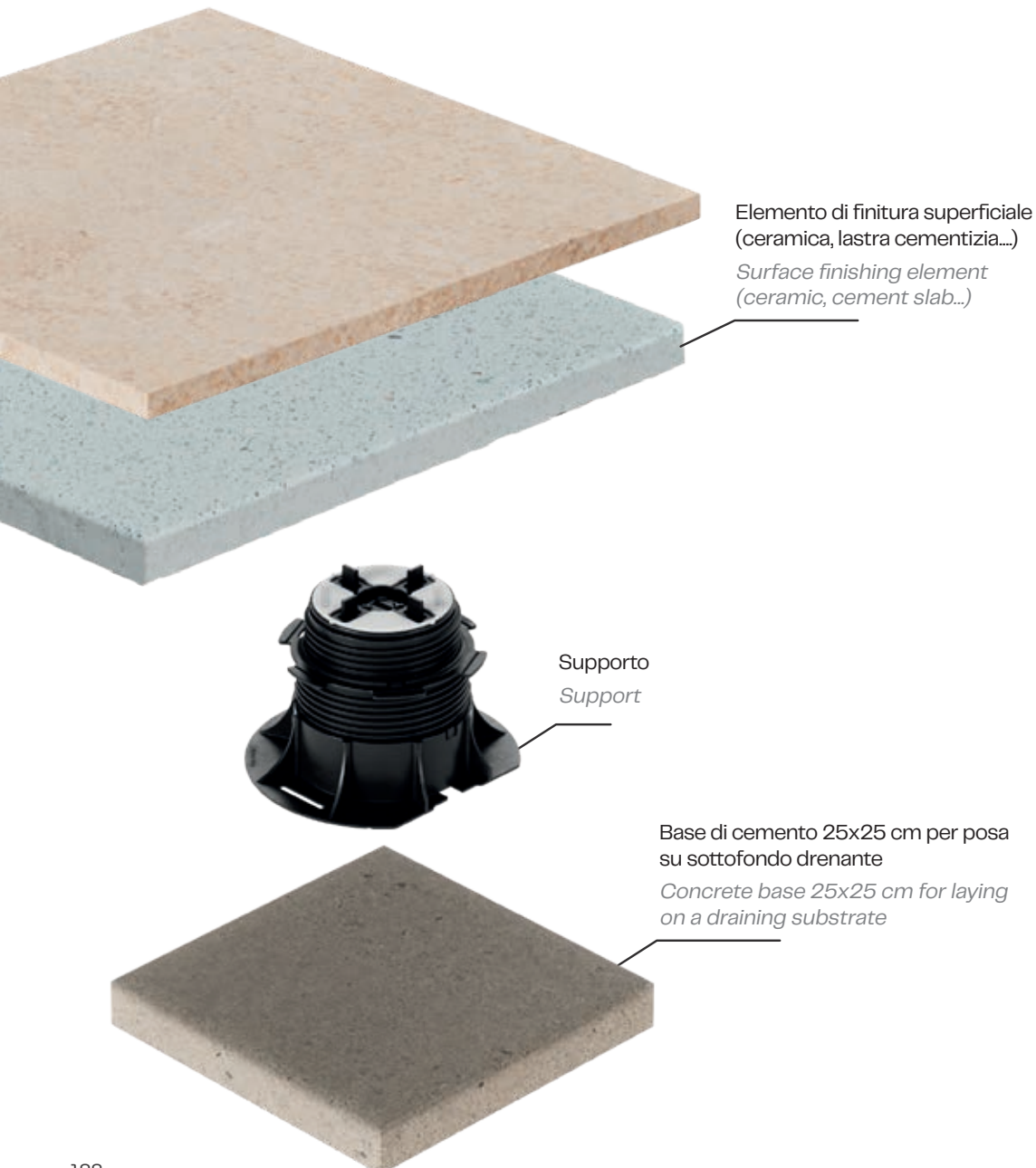

Posa Pedestal con ceramica

Laying Pedestal with ceramic slabs



Step 01: i supporti

Posizionare i supporti sul piano di posa e regolare l'altezza desiderata. Al fine di migliorarne la portata è possibile aggiungere un supporto al centro di ogni lastra e/o al centro dei 4 lati.

Step 01: the supports

To install the supports, place them on the laying surface and adjust them to the desired height.

To enhance their load-bearing capacity, it is possible to add a support at the center of each slab and/or at the center of all four sides.



Step 02: la pavimentazione

Appoggiare le lastre di ceramica direttamente sui supporti.

Step 02: the floor

Lay ceramic slabs directly on the supports.

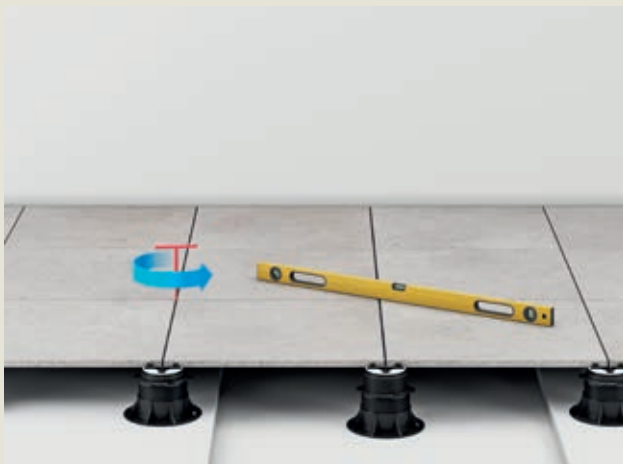

Step 03: la regolazione

Regolare infine la pavimentazione attraverso la speciale chiave Eterno Ivica che permette una regolazione millimetrica e un pavimento perfettamente livellato.

Step 03: the adjustment

Finally, adjust the flooring using the special Eterno Ivica key, which allows for millimetric adjustments and ensures a perfectly leveled floor.

Consumo dei supporti al metro quadro

Support consumption per square meter

MISURA LASTRE SLABS SIZE	20	30	40	45	50	60	70	75	80	90	100
20	25	16,67	12,5	11,11	10	8,33	14,29	13,33	12,5	11,11	10
30	16,67	11,11	8,33	7,41	6,67	5,56	9,52	8,89	8,33	7,41	6,67
40	12,5	8,33	6,5	5,56	5	4,17	7,14	6,67	6,65	5,56	5
45	11,1	7,41	5,56	4,94	4,44	3,7	6,35	5,63	5,56	4,94	4,44
50	10	6,67	5	4,44	4	3,33	5,71	5,33	5	4,44	4
60	8,3	5,56	4,17	3,7	3,33	2,78	4,76	4,44	4,17	3,7	3,33
70	14,29	9,52	7,14	6,35	5,71	4,76	4,08	3,81	3,57	3,17	2,86
75	13,33	8,89	6,67	5,93	5,33	4,44	3,81	3,56	3,33	2,96	2,67
80	12,5	8,33	6,25	5,56	5	4,17	3,57	3,33	6,25	5,56	5
90	11,11	7,41	5,56	4,94	4,44	3,7	3,17	2,96	5,56	4,94	4,44
100	10	6,67	5	4,44	4	3,33	2,86	2,67	5	4,44	4
120	8,33	5,56	4,17	3,7	3,33	2,78	2,38	2,22	4,17	3,7	3,33
140	14,29	9,52	7,14	6,35	5,71	4,76	2,04	1,9	3,57	3,17	2,86
160	12,5	8,33	6,25	5,56	5	4,17	3,57	3,33	6,25	5,56	5
180	8,33	5,56	4,17	3,7	3,33	2,78	2,38	2,22	4,17	3,7	3,33

NB: questa tabella è un puro calcolo matematico e non tiene conto di tutte le variabili di cantiere pertanto i valori di consumo sono indicativi e vi invitiamo ad aumentare i valori sopraindicati del 5 - 15 %.

Consigliamo di rivolgersi sempre ai nostri tecnici.

NB: this table is a pure mathematical calculation and does not take into account all the site variables, so the consumption values are indicative and we recommend to increase the above values by 5-15%.

We always suggest increasing contacting our specialists.

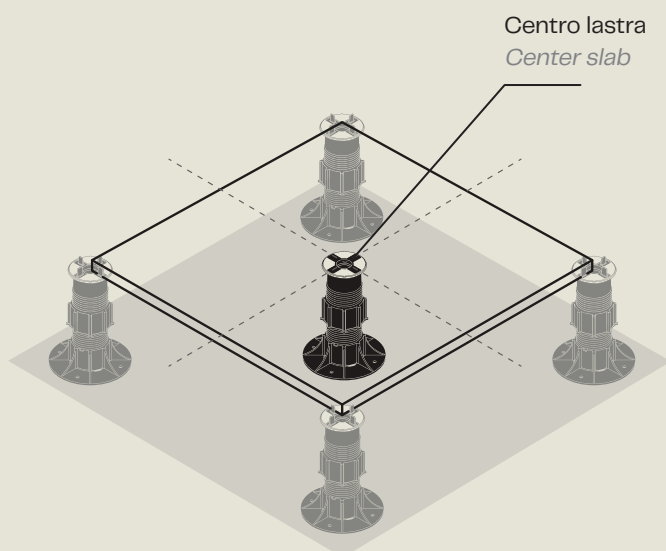
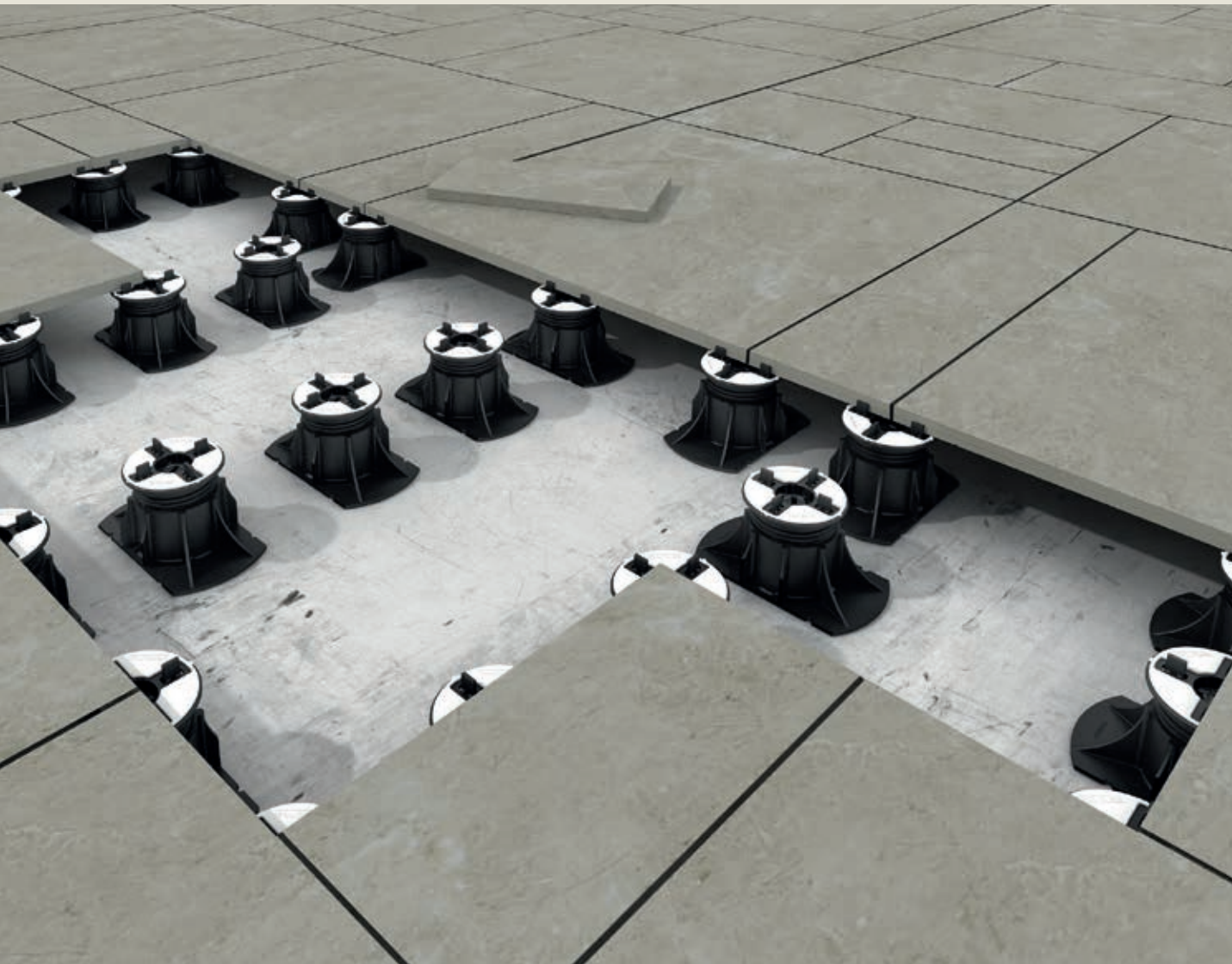

Testa per supporto centrale

Head for central support

L'uso del "Supporto Centrale", da posizionarsi al centro della lastra, conferisce maggiore portata alla pavimentazione.

Il supporto si regola agendo sulla base tenendo ferma la testa, senza l'ausilio della chiave di regolazione.

The use of the "Central Support" to be placed at the center of the slab, gives greater resistance to the floor. The support is adjusted by acting on the base while holding the head, without the aid of the adjustment key.

Schemi di montaggio

Lastre | Slabs 20x120 cm

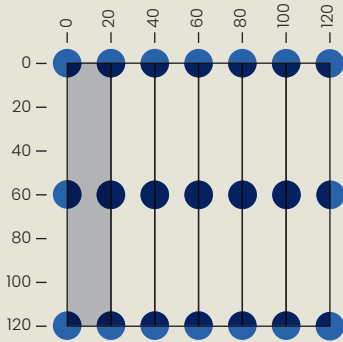

Lastre | Slabs 30x60 cm

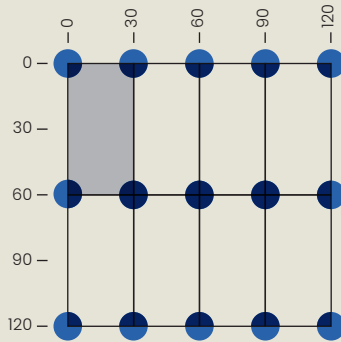

Lastre | Slabs 30x90 cm

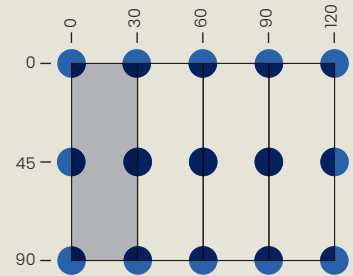

Lastre | Slabs 30x120 cm

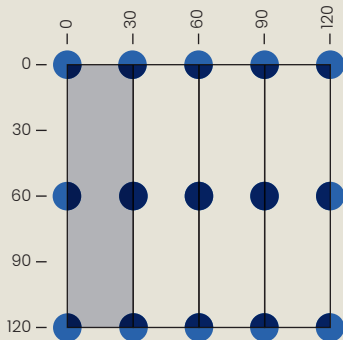

Lastre | Slabs 30x180 cm

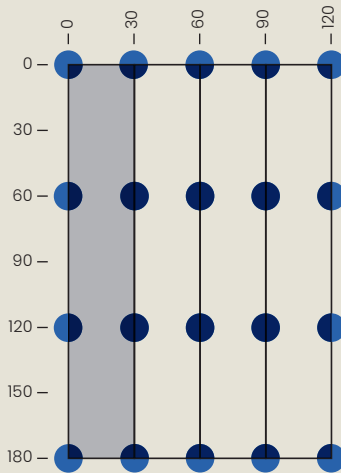

Lastre | Slabs 40x40 cm

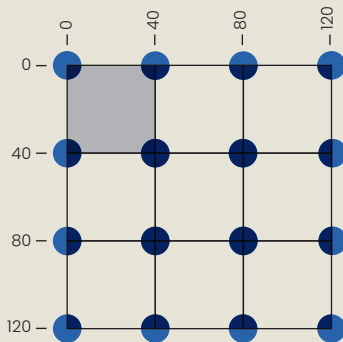

Lastre | Slabs 40x60 cm

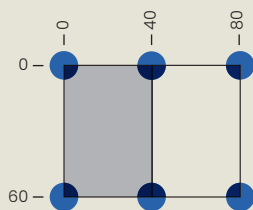

Lastre | Slabs 40x80 cm

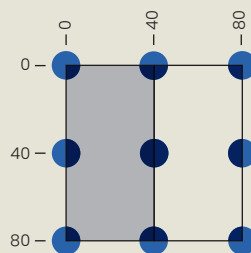

Lastre | Slabs 40x90 cm

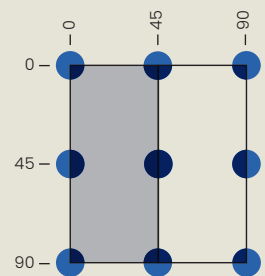

Assembly diagrams

Lastre | Slabs 40x120 cm

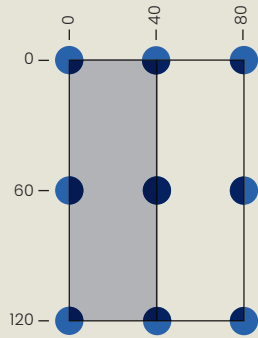

Lastre | Slabs 40x180 cm

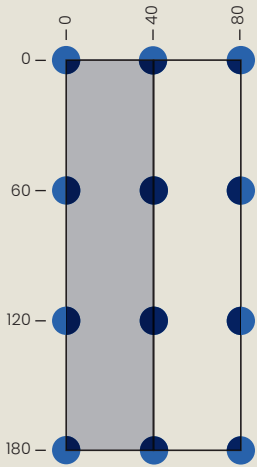

Lastre | Slabs 45x90 cm

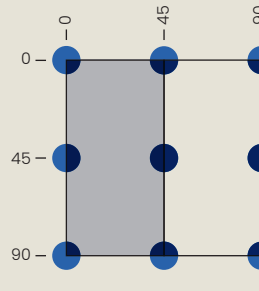

Lastre | Slabs 50x50 cm

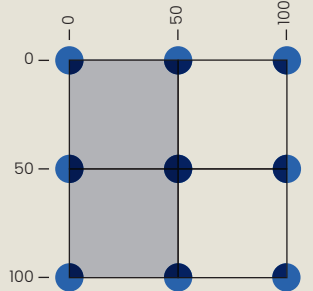

Lastre | Slabs 60x60 cm

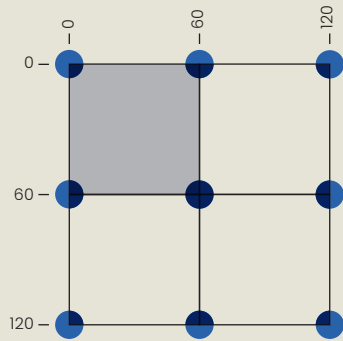

Lastre | Slabs 60x90 cm

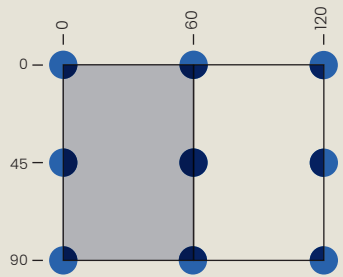

Lastre | Slabs 60x120 cm

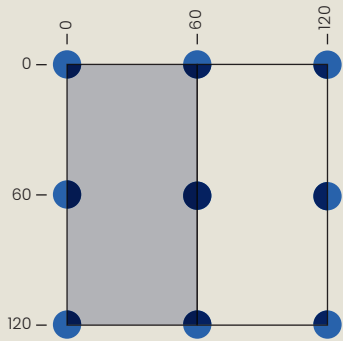

Lastre | Slabs 120x120 cm

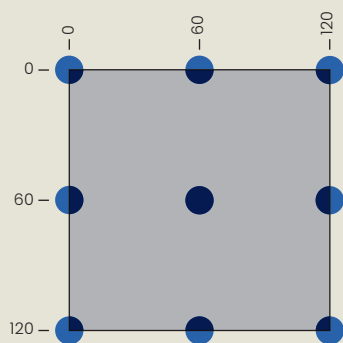

Lastre | Slabs 75x75cm

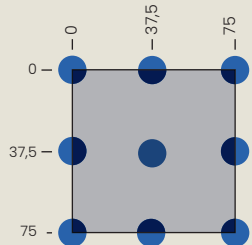

Lastre | Slabs 80x80 cm

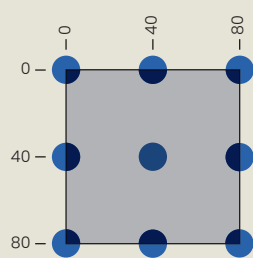

Lastre | Slabs 90x90 cm

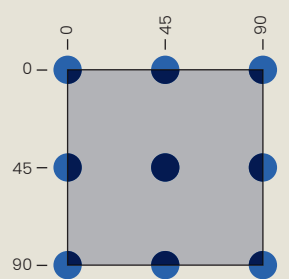

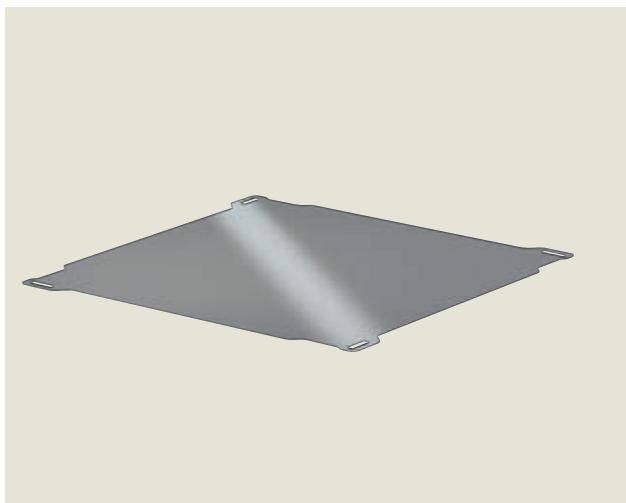

Piastra di sicurezza Safety plate

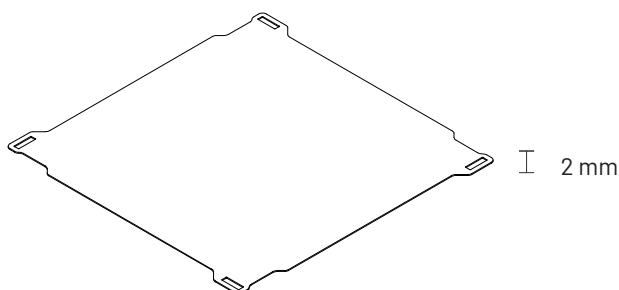

La lastra di sicurezza di Eterno Ivica è costituita da una lamina di acciaio zincato dello spessore di 2 mm, opportunamente sagomata al fine di sostenere gli elementi di pavimentazione in caso di rottura accidentale, annullando i rischi di incidenti in quanto la lastra di sicurezza sosterrà sia l'elemento di pavimentazione che l'eventuale persona.

In caso di rottura accidentale dell'elemento di pavimentazione la lastra di sicurezza "aggancerà" le alette distanziatrici delle teste dei supporti in modo da aumentarne la resistenza.

Di facile applicazione, la lastra di sicurezza viene posata sopra le teste dei supporti regolabili inserendosi perfettamente nelle alette distanziatrici, la particolare forma consente all'acqua piovana di drenare tramite le "fughe" tra gli elementi di pavimentazione.

È consigliabile abbinare assieme alla lastra di sicurezza il livellatore LGH1 in modo da permettere all'elemento di pavimentazione soprastante di appoggiare sempre su uno strato di gomma, il quale ha la funzione di anti-rumore e anti-scivolamento, con questo sistema la lastra di sicurezza è compresa tra due strati di gomma, sia nella parte inferiore che superiore.

The safety plate by Eterno Ivica consists of a 2 mm thick galvanized steel sheet, suitably shaped in order to support the flooring elements in the event of accidental breakage, eliminating the risk of accidents as the safety plate will support both the flooring element and the possible person.

In the event of accidental breaking of the flooring element, the safety plate will "hook" the spacing tabs of the heads of the supports so as to increase their resistance.

Easy to apply, the safety plate is placed above the heads of the adjustable supports, fitting perfectly into the spacer tabs; its particular shape allows the rainwater to drain through the "joints" between the flooring elements.

It is advisable to combine the LGH1 leveler together with the safety plate in order to allow the overlying flooring element to always rest on a layer of rubber, which has the function of anti-noise and anti-slip; with this system the safety plate is included between two layers of rubber, both in the lower and upper part.

CODICE CODE	DESCRIZIONE DESCRIPTION	MISURA SIZE	PAG. LISTINO PRICE LIST PAGE	PZ 	PZ 
P021100060	Piastra di sicurezza <i>Safety plate</i>	600x600x2 mm*	58	-	-

* Le altre dimensioni sono su richiesta.

* Other dimensions are on request.

Livellatori in gomma

Rubber shims



LH 3



LGH 1, 2, 3

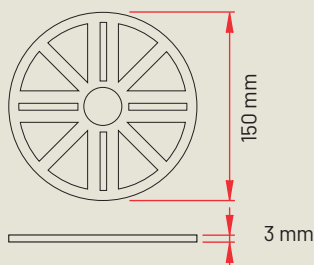

LH 3 - Livellatore in gomma LH3
LH 3 - Rubber shim

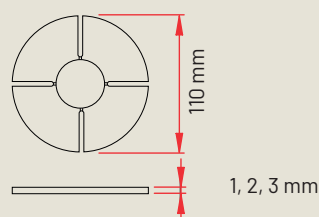

LGH1 - LGH2 - LGH3 - 1-2-3 mm - Ø 110 mm
Livellatore in gomma LGH1, LGH2 e LGH3 con effetto antiscivolo e antirumore
LGH1, LGH2 and LGH3 rubber shim. Non-slip and anti-noise

I livellatori possono compensare da 1 a 3 mm di spessore e possono essere posizionati sulle teste dei supporti PR, SR/SRT, SE, NM, SB, ST e EH.

Realizzati in gomma con effetto antiscivolo e antirumore si differenziano in LGH da 1, 2 e 3 mm con diametro 110 mm e LH3 di 3 mm di spessore con diametro di 150 mm.

The levelers can compensate from 1 to 3 mm in thickness and can be positioned on the heads of the PR, SR/SRT, SE, NM, SB, ST and EH supports.

Made of rubber with anti-slip and anti-noise effect, they differ in LGH 1, 2 and 3 mm with diameter 110 mm and LH3 3 mm thick with a diameter of 150 mm.

CODICE CODE	DESCRIZIONE DESCRIPTION	MISURA SIZE	PAG. LISTINO PRICE LIST PAGE	PZ 	PZ
E081003000	Livellatore gomma LH3 LH3 rubber shim	Ø 150 mm H 3 mm	58	250	-
E082001000	Livellatore gomma LGH1 LGH1 rubber shim	Ø 110 mm H 1 mm	58	800	-
E082002000	Livellatore gomma LGH2 LGH2 rubber shim	Ø 110 mm H 2 mm	58	600	-
E082003000	Livellatore gomma LGH3 LGH3 rubber shim	Ø 110 mm H 3 mm	58	500	-

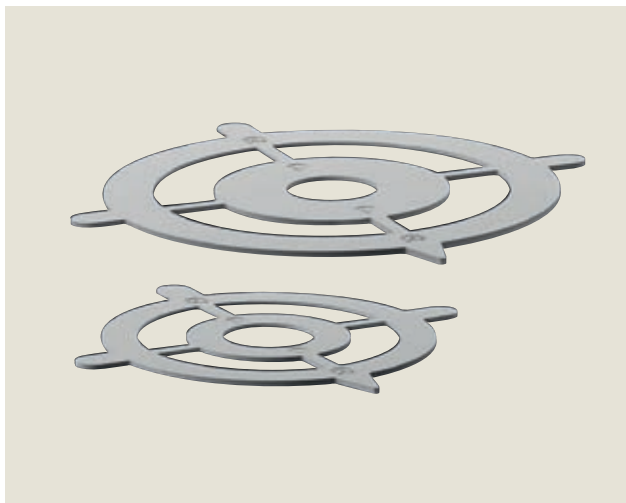

Compensatore di pendenza

Slope compensator



Soluzione modulare, risultato matematicamente perfetto!

I compensatori di pendenza Twist abbinati fra loro sommano le loro performance di regolazione per giungere con facilità, mediante una semplice rotazione, al risultato desiderato.

Ogni compensatore, da posizionare sulla testa dei supporti SR/SRT, NM, SB, ST e EH, consente l'inclinazione da 0% fino a 1%: opportunamente sommati e regolati assicurano la perfetta planarità di qualsiasi pavimentazione.

Modular solution, the result is mathematically perfect!

Twist slope compensator combined together add up their adjusting performance to reach the desired result with ease, by means of a simple turn.

Each compensator, positioned on SR/SRT, NM, SB, ST and EH head supports, allows the inclination from 0% up to 1%: suitably adjusted and summed to ensure the perfect flatness of any floor.

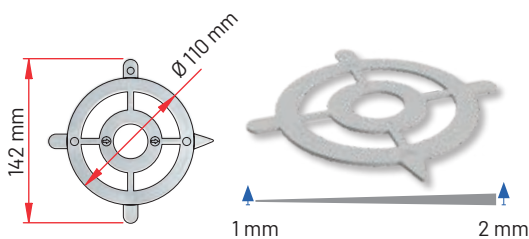
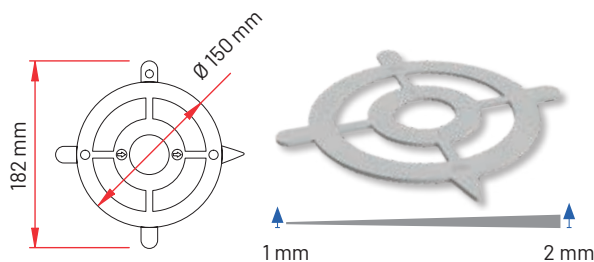

Vantaggi

Advantages

La semplicità di un gesto per una planarità perfetta.

Il Compensatore di pendenza Twist, compatibile con i supporti SR/SRT, NM, SB, ST e EH, è stato studiato per consentire il livellamento di pendenze da 0% fino a 1% con un semplice gesto. Modulare e facile da regolare con una semplice rotazione, consente di ottenere superfici perfettamente planari.

È possibile utilizzare più compensatori insieme, sommandoli tra loro, fino a raggiungere la percentuale di livellamento desiderato.

The simplicity of a movement for a perfect flatness.

The Twist slope compensator, compatible with the SR/SRT, NM, SB, ST and EH supports has been studied to allow the leveling of slopes from 0% up to 1% degree with a simple movement. It is modular and easy to adjust with a simple rotation, allows for perfectly flat surfaces.

It is possible to use several compensators, adding them together, until reaching the desired percentage of leveling.

Dettagli tecnici

Technical details

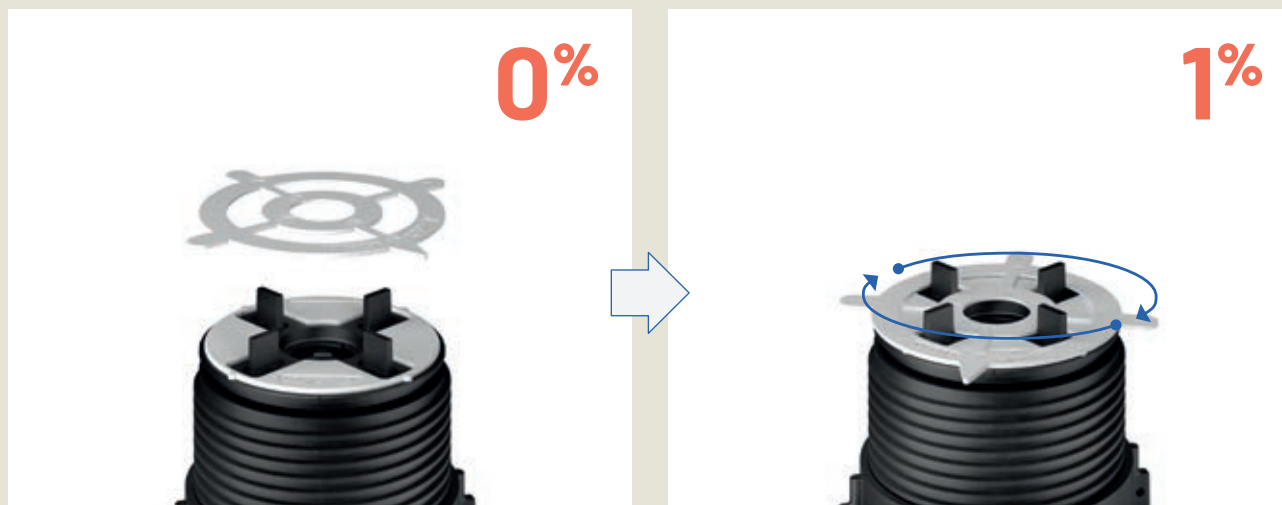

Il Compensatore di pendenza Twist viene posizionato sopra la testa dei supporti SR/SRT, NM, SB, ST, EH.
The Twist slope compensator is placed over the head of SR/SRT, NM, SB, ST, EH support.

Rotazione del Compensatore di pendenza Twist fino a 1%.
Compensator rotation slope Twist up to 1%.

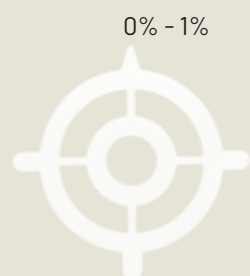

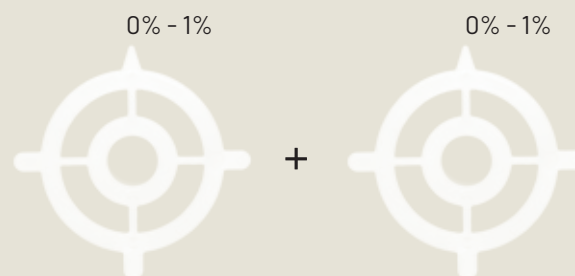

Fino a 1%
Up to 1%

1 Compensatore di pendenza Twist fino a 1% di regolazione della pendenza
1 Twist slope compensator up to 1% of the slope adjustment



Fino a 2% e oltre
Up to 2% and more

2 Compensatori di pendenza Twist fino a 2% di regolazione della pendenza
2 Twist slope compensators up to 2% of the slope adjustment

CODICE CODE	DESCRIZIONE DESCRIPTION	MISURA SIZE	PAG. LISTINO PRICE LIST PAGE	PZ 	PZ 
E084000110	Compensatore di pendenza Twist TW 110 <i>Twist slope compensator TW 110</i>	Ø 110 mm	58	700	-
E084000150	Compensatore di pendenza Twist TW 150 <i>Twist slope compensator TW 150</i>	Ø 150 mm	58	250	-



Profilo bordo lastra

Slab edge profile



Il profilo Bordo Lastra di Eterno Ivica è pensato per delimitare i bordi perimetrali di un pavimento sopraelevato in corrispondenza di un rivestimento verticale. Il Profilo Bordo Lastra ha pertanto una parte a vista decorativa di 30 mm e un dente posteriore che va a mantenere in posizione verticale le lastre perimetrali. Disponibili in acciaio inox spazzolato sp. 1 mm e alluminio sp. 1,5 mm. Il tutto per garantire un effetto estetico a regola d'arte.

The slab edge profile by Eterno Ivica is designed to limit the raised floor's edges in correspondence with a vertical covering. The slab edge profile has a 30 mm decorative part and a tooth overlapped to the vertical slab in order to hide the junction with the floor. It is available in stainless steel (IS) 1 mm thick and aluminium 1,5 mm thick. Everything is made up to guarantee a state-of-the-art aesthetic result.

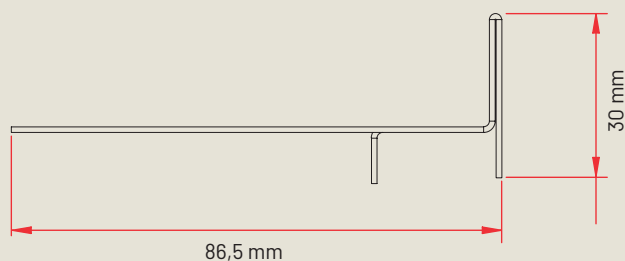

CODICE CODE	DESCRIZIONE DESCRIPTION	MISURA SIZE	PAG. LISTINO PRICE LIST PAGE	PZ 	PZ
P021200020	Profilo bordo lastra acciaio inox <i>Stainless steel slab edge profile</i>	1,20 mt	58	-	-
P021200120	Profilo bordo lastra alluminio <i>Aluminium slab edge profile</i>	1,20 mt	58	-	-

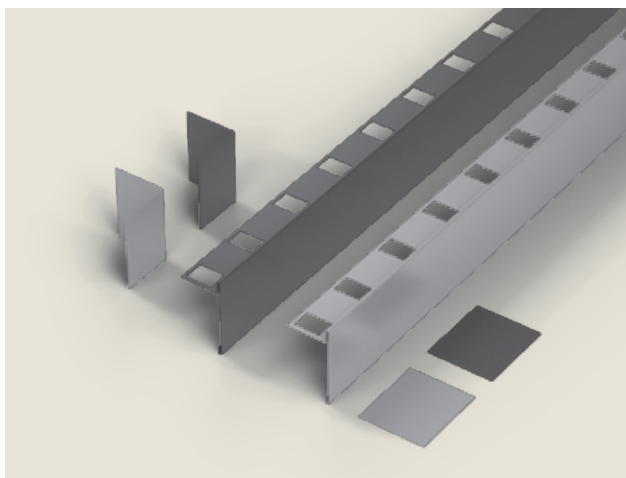

Profilo perimetrale verticale



Vertical perimeter profile

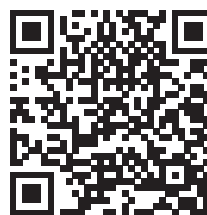

Guarda il video
di presentazione



Watch the
presentation video

Il Profilo Perimetrale Verticale è un elemento di chiusura e finitura dei bordi perimetrali nelle pavimentazioni so-praelevate esterne, si adatta perfettamente alle lastre di pavimentazione dello spessore di 20 mm e ai supporti che fungono da sottostruttura.

È un prodotto che combina l'estetica con la funzionalità e rende ancora più gradevole una pavimentazione esterna.

Il profilo è in alluminio e viene proposto in due colori standard: silver e grigio antracite; è corredato di due importanti accessori che sono il giunto lineare e il giunto angolare a 90°, anch'essi in alluminio e con le medesime colorazioni del profilo. Il profilo ha una lunghezza di 2,40 m mentre le altezze standard sono di 30-60-90-120-150 mm.

Di facile e veloce installazione, è sufficiente appoggiare il lato con le feritoie sulle teste dei supporti, accostare i profili e inserire i giunti (lineare e ad angolo). Si adatta perfettamente alle lastre di pavimentazione aventi misure di 600x600, 750x750, 800x800, 900x900, 400x800, 450x900, 300x1200, 400x1200, 600x1200, 1200x1200 mm.

The Vertical Perimeter Profile is an element of closure and finishing of the perimeter edges in the external raised flooring, it adapts perfectly to the flooring slabs of 20 mm thickness and to the supports that act as a substructure. It is a product that combines aesthetics with functionality and makes an outdoor flooring even more pleasant.

The profile is in aluminium and is available in two standard colours: silver and anthracite gray. It is equipped with two important accessories that are the linear joint and the 90° angular joint, also in aluminium and with the same colours of the profile.

The profile has a length of 2.40 meters while the standard heights are 30-60-90-120-150 mm. Easy and quick to install, simply place the side with the slits on the heads of the supports, pull together the profiles and insert the joints (linear and angular). It fits perfectly into flooring slabs measuring 600x600, 750x750, 800x800, 900x900, 400x800, 450x900, 600x1200, 1200x1200 mm.

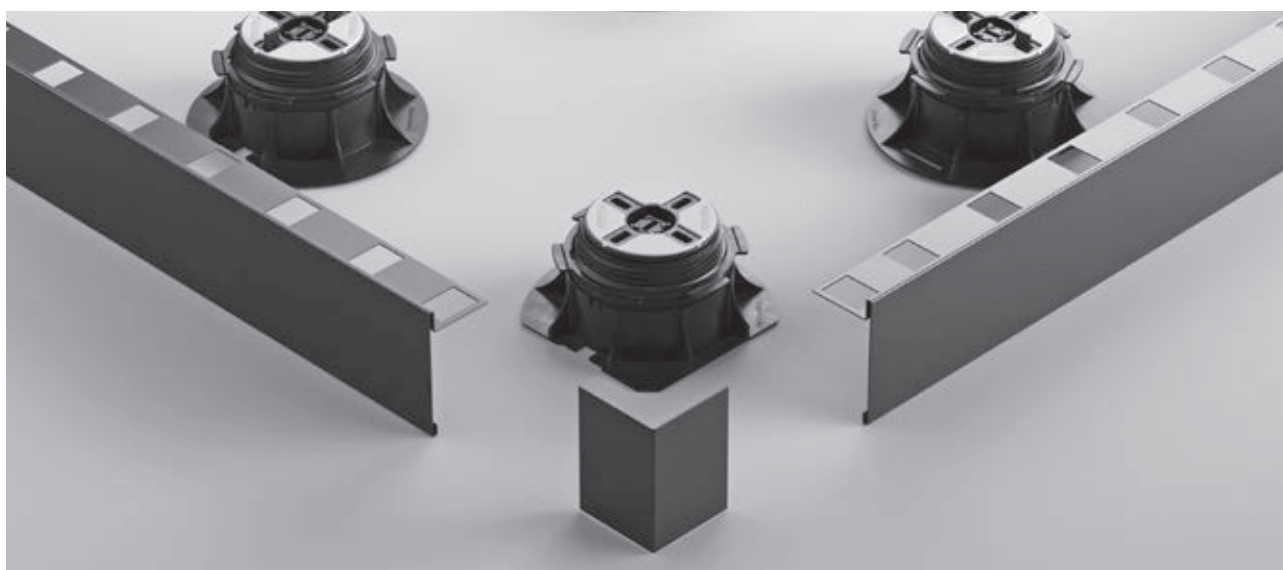

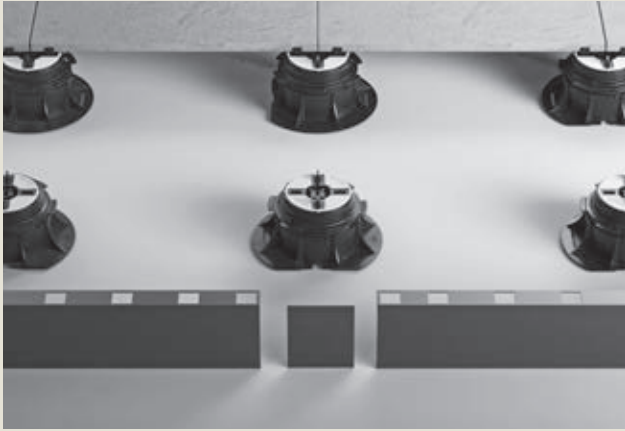

Giunto lineare
Linear joint

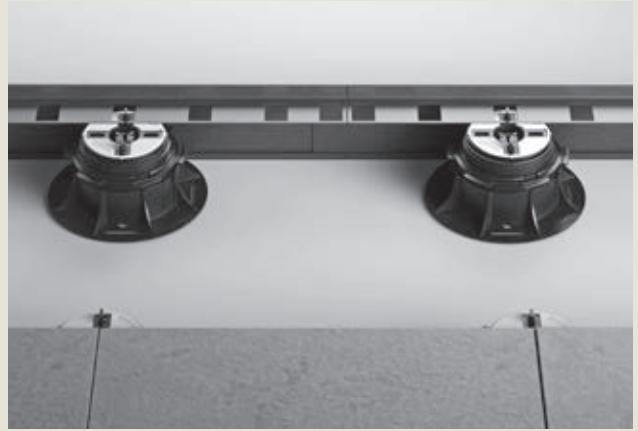

Posizionamento profilo sui supporti
Positioning of the profile on the supports

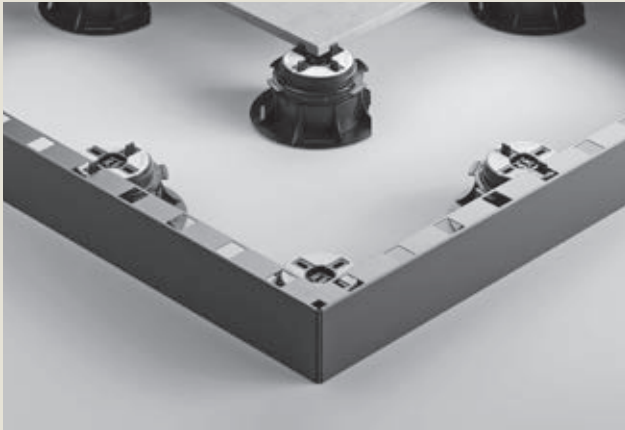

Angolo esterno
External corner



Angolo interno
Internal corner

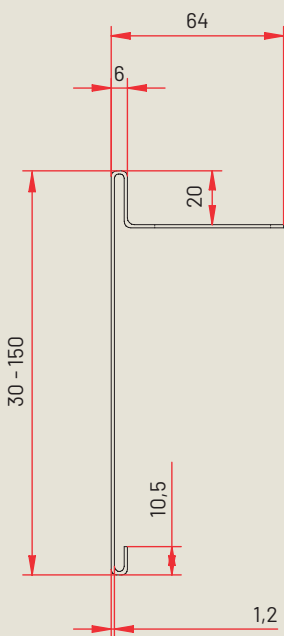

Le misure sono espresse in millimetri.

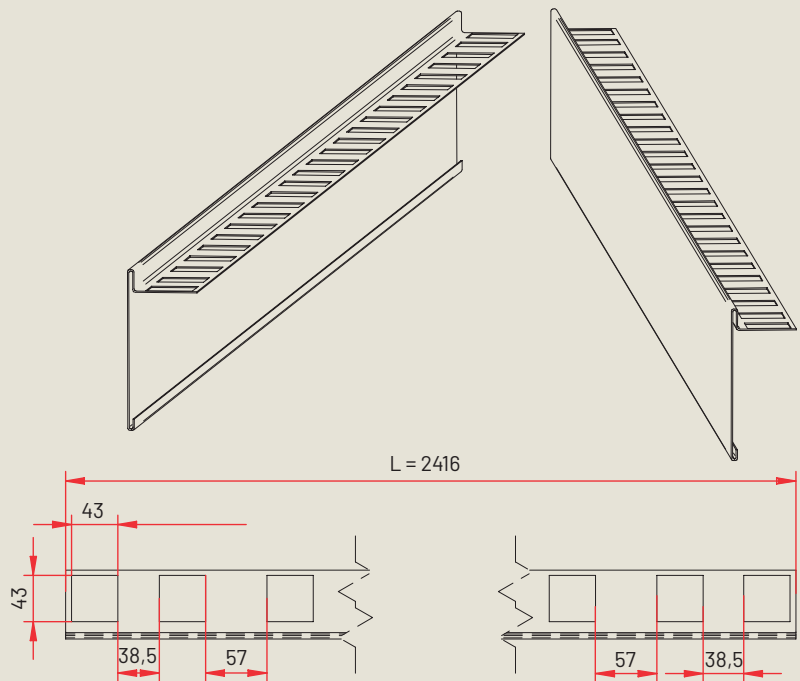

Measurements are expressed in millimeters.

CODICE CODE	COLORE COLOR	DESCRIZIONE DESCRIPTION	ALTEZZA HEIGHT H	LAR- GHEZZA LENGHT L	PAG. LISTINO PRICE LIST PAGE	PZ 
P021241030	Silver	Profilo perimetrale verticale <i>Vertical perimeter profile</i>	30 mm	2400 mm	59	10
P021251030	Antracite <i>Anthracite</i>					
P021241060	Silver	Profilo perimetrale verticale <i>Vertical perimeter profile</i>	60 mm	2400 mm	59	10
P021251060	Antracite <i>Anthracite</i>					
P021241090	Silver	Profilo perimetrale verticale <i>Vertical perimeter profile</i>	90 mm	2400 mm	59	5
P021251090	Antracite <i>Anthracite</i>					
P021241120	Silver	Profilo perimetrale verticale <i>Vertical perimeter profile</i>	120 mm	2400 mm	59	5
P021251120	Antracite <i>Anthracite</i>					
P021241150	Silver	Profilo perimetrale verticale <i>Vertical perimeter profile</i>	150 mm	2400 mm	59	5
P021251150	Antracite <i>Anthracite</i>					
P021242030	Silver	Angolo 90° <i>90° angle</i>	30 mm	-	59	1
P021252030	Antracite <i>Anthracite</i>					
P021242060	Silver	Angolo 90° <i>90° angle</i>	60 mm	-	59	1
P021252060	Antracite <i>Anthracite</i>					
P021242090	Silver	Angolo 90° <i>90° angle</i>	90 mm	-	59	1
P021252090	Antracite <i>Anthracite</i>					
P021242120	Silver	Angolo 90° <i>90° angle</i>	120 mm	-	59	1
P021252120	Antracite <i>Anthracite</i>					
P021242150	Silver	Angolo 90° <i>90° angle</i>	150 mm	-	59	1
P021252150	Antracite <i>Anthracite</i>					
P021243030	Silver	Giunto lineare <i>Linear joint</i>	30 mm	-	59	1
P021253030	Antracite <i>Anthracite</i>					
P021243060	Silver	Giunto lineare <i>Linear joint</i>	60 mm	-	59	1
P021253060	Antracite <i>Anthracite</i>					
P021243090	Silver	Giunto lineare <i>Linear joint</i>	90 mm	-	59	1
P021253090	Antracite <i>Anthracite</i>					
P021243120	Silver	Giunto lineare <i>Linear joint</i>	120 mm	-	59	1
P021253120	Antracite <i>Anthracite</i>					
P021243150	Silver	Giunto lineare <i>Linear joint</i>	150 mm	-	59	1
P021253150	Antracite <i>Anthracite</i>					

Clip tamponamento verticale

Vertical lining clip



Progettate per far fronte a un problema comune a tante pavimentazioni esterne, ovvero il tamponamento del bordo quando si è in assenza del muro perimetrale, le clip per tamponamento verticale costituiscono un innovativo sistema che permette di chiudere facilmente ed elegantemente lo spazio perimetrale che si crea in presenza di pavimentazioni sopraelevate. Una soluzione composta di due particolari clip in acciaio inox che, messe sopra la testa e sotto la base del supporto Eterno Ivica, creano una sede con dei mordenti che incastrano la porzione di pavimentazione rifilata a misura dello spazio da tamponare, evitando in modo contestuale lo scivolamento delle lastre orizzontali grazie al blocco posto all'estremità della clip. Grazie a questo sistema è possibile realizzare anche dei gradini.

Our clip for vertical closure is designed to solve a problem typical of many external floors, i.e. how to fill in the gap around the edge when no perimeter wall is present. This solution represents an innovative, easy and elegant way to eliminate gaps around raised floors. The system consists of two special, stainless steel clips for positioning over the head and under the base of the Eterno Ivica support. It creates a firm seat capable of gripping the section of floor cut to size to fill the gap. The use of our floor edge clip effectively prevents horizontal movement in floor slabs. Thanks to this system it is also possible to create steps.

Dettagli tecnici

Technical details



Installazione tamponamento verticale
Vertical infill installation

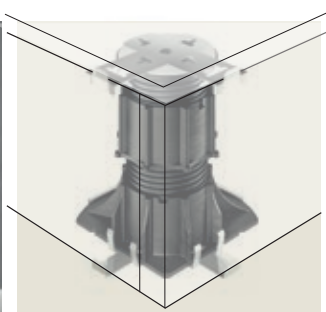

Dettaglio di posa delle clip per la realizzazione degli angoli dei gradini
Detail of clips installation for creating the corners of the steps



Clip per testa standard
Clip for standard head



Clip per testa XL
Clip for XL head

CODICE CODE	DESCRIZIONE DESCRIPTION	COMPATIBILITÀ SUPPORTI COMPATIBILITY SUPPORTS	Ø TESTA SUPPORTI Ø HEAD OF SUPPORTS	SPESSORE LASTRA SLAB THICKNESS	PAG. LISTINO PRICE LIST PAGE	PZ 
P021000425	Clip testa <i>Head clip</i>	SE - NM - SB	110 mm	20 mm	60	100
P021000458	Clip testa <i>Head clip</i>	PR - SR/SRT NM solo base a rottura facilitata <i>NM only with easy break base</i>	110/150 mm	20 mm	60	100
P021000452	Clip testa <i>Head clip</i>	SE - NM	150 mm	20 mm	60	100
P021000322	Clip base <i>Base clip</i>	NM con base a rottura facilitata <i>NM with easy break base</i> SE - NM - SB PR - SR/SRT	110/150 mm 110 mm 110/150 mm	20 mm	60	100
P021000352	Clip base <i>Base clip</i>	SE - NM	150 mm	20 mm	60	100
P021000426	Clip testa <i>Head clip</i>	SE - NM - SB	110 mm	30 mm	60	100
P021000459	Clip testa <i>Head clip</i>	PR NM solo base a rottura facilitata <i>NM only with easy break base</i>	110/150 mm	30 mm	60	100
P021000459.N	Clip testa <i>Head clip</i>	SR/SRT	110/150 mm	30 mm	60	100
P021000453	Clip testa <i>Head clip</i>	SE - NM	150 mm	30 mm	60	100
P021000323	Clip base <i>Base clip</i>	NM con base a rottura facilitata <i>NM with easy break base</i> SE - NM - SB PR - SR/SRT	110/150 mm 110 mm 110/150 mm	30 mm	60	100
P021000353	Clip base <i>Base clip</i>	SE - NM	150 mm	30 mm	60	100
P021000427	Clip testa <i>Head clip</i>	SE - NM - SB	110 mm	40 mm	60	100
P021000460	Clip testa <i>Head clip</i>	PR NM solo base a rottura facilitata <i>NM only with easy break base</i>	110/150 mm	40 mm	60	100
P021000460.N	Clip testa <i>Head clip</i>	SR/SRT	110/150 mm	40 mm	60 100	
P021000454	Clip testa <i>Head clip</i>	SE - NM	150 mm	40 mm	60	100
P021000324	Clip base <i>Base clip</i>	NM con base a rottura facilitata <i>NM with easy break base</i> SE - NM - SB PR - SR/SRT	110/150 mm 110 mm 110/150 mm	40 mm	60	100
P021000354	Clip base <i>Base clip</i>	SE - NM	150 mm	40 mm	60	100

Clip tamponamento verticale angolare

Vertical angular lining clip



Testa
Head



Base
Base

Questa particolare CLIP, sia di Testa che di Base, viene impiegata nel caso di un tamponamento verticale ad "angolo", anziché utilizzare due clip di Testa e due clip di Base si utilizza una unica clip di Testa e una unica clip di Base. Una soluzione composta da due particolari clip che, messe sopra la testa e sotto la base del supporto, appositamente tagliato ad "angolo", creano una sede con dei mordenti che incastrano la porzione di pavimentazione rifilata a misura dello spazio da tamponare. È realizzata in acciaio inox, semplice e veloce da installare. Grazie a questo sistema è possibile realizzare anche dei gradini.

This particular CLIP, both of the Head and of the Base, is used in the case of a vertical "corner" infill, instead of using two Head clips and two Base clips, a single Head clip and a single Base clip are used. A solution consisting of two particular clips which, placed above the head and under the base of the support, specially cut at an angle, create a seat with mordants that fit the portion of the flooring trimmed to the extent of the space to be plugged. It is made of stainless steel, simple and quick to install. Thanks to this system it is also possible to create steps.

CODICE CODE	DESCRIZIONE DESCRIPTION	COMPATIBILITÀ SUPPORTI COMPATIBILITY SUPPORTS	Ø TESTA SUPPORTI Ø HEAD OF SUPPORTS	SPESSORE LASTRA SLAB THICKNESS	PAG. LISTINO PRICE LIST PAGE	PZ
P021000972	Clip testa <i>Head clip</i>	SE - NM - SB	110 mm	20 mm	61	25
P021000982	Clip testa <i>Head clip</i>	PR - NM con base a rottura facilitata <i>PR - NM with easy break base</i>	110/150 mm	20 mm	61	25
		SE - NM	150 mm			
P021000982.N	Clip testa <i>Head clip</i>	SR/SRT	110/150 mm	20 mm	61	25
P021000912	Clip base <i>Base clip</i>	PR - SR/SRT - NM con base a rottura facilitata <i>PR - SR/SRT - NM with easy break base</i>	110/150 mm	20 mm	61	25
		SE - NM - SB	110 mm			
		PR	150 mm			
P021000922	Clip base <i>Base clip</i>	SE - NM	150 mm	20 mm	61	25

Dettagli tecnici Technical details



Clip per testa standard
Clip for standard head



Clip per testa XL
Clip for XL head



Installazione tamponamento verticale angolare
Vertical angular infill installation





Clip lastre esagonali

Clip for hexagonal slabs



Con la semplice e veloce applicazione di una piccola clip in polipropilene sulle teste dei supporti PR, SE e NM possiamo rispondere alle esigenze creative di architetti e clienti che vedono nelle lastre esagonali una possibile e fantasiosa soluzione estetica per la realizzazioni di pavimentazioni sopraelevate da esterno.

Il distanziale delle lastre è disponibile per fughe di 4, 3 e 2 mm.

With the simple and quick application of a small polypropylene clip on the heads of PR, SE and NM supports, we can meet the creative needs of architects and customers who see in the hexagonal slabs a possible and imaginative aesthetic solution for the realization of raised floors for outdoor use.

The slab spacer is available for 4, 3 and 2 mm joints.

CODICE CODE	DESCRIZIONE DESCRIPTION	MISURA SIZE	PAG. LISTINO PRICE LIST PAGE	PZ* 	PZ 
E004001004	Dist. lastra esagonale aletta sp. 4 mm <i>Hexagonal slab spacer with tabs thickness 4 mm</i>	-	61	400	-
E004001003	Dist. lastra esagonale aletta sp. 3 mm <i>Hexagonal slab spacer with tabs thickness 3 mm</i>	-	61	400	-
E004001002	Dist. lastra esagonale aletta sp. 2 mm <i>Hexagonal slab spacer with tabs thickness 2 mm</i>	-	61	400	-
E035100040	Testa SE basculante per accessori <i>SE tilting head for accessories</i>	Ø 110 mm	61	200	
E034000040	Testa NM per accessori <i>NM head for accessories</i>	Ø 110 mm	61	200	

NB: le clip devono sempre essere ordinate con le teste SE o NM Ø 110 mm, vedi codici sopra descritti.

* Le scatole sono composte da 4 sacchetti da pz. 100.

NB: the clips must always be ordered with the SE or NM heads Ø 110 mm, see the codes described above.

** The boxes are made up of 4 x 100 pieces bags.*



Accessorio per aumentare lo spessore delle alette

Tool to increase the thickness of the tabs



Questo accessorio consente di aumentare lo spessore delle alette, viene semplicemente inserito a pressione nelle alette con spessore 4 mm, disponibile per misure da 5-6-7-8-9-10 mm.

L'altezza delle alette rimane invariata, 12 mm.

This accessory allows to increase the thickness of the tabs, it is simply pushed into the 4 mm thick tabs and it is available for sizes from 5-6-7-8-9-10 mm. The 12 mm height of the tabs remains unchanged.

CODICE CODE	DESCRIZIONE DESCRIPTION	MISURA SIZE	PAG. LISTINO PRICE LIST PAGE	PZ* 
E004000305	Accessorio per aumentare lo spessore delle alette <i>Tool to increase the thickness of the tabs</i>	spessore 5 mm <i>thickness 5 mm</i>	62	2500
E004000306	Accessorio per aumentare lo spessore delle alette <i>Tool to increase the thickness of the tabs</i>	spessore 6 mm <i>thickness 6 mm</i>	62	2500
E004000307	Accessorio per aumentare lo spessore delle alette <i>Tool to increase the thickness of the tabs</i>	spessore 7 mm <i>thickness 7 mm</i>	62	2500
E004000308	Accessorio per aumentare lo spessore delle alette <i>Tool to increase the thickness of the tabs</i>	spessore 8 mm <i>thickness 8 mm</i>	62	2500
E004000309	Accessorio per aumentare lo spessore delle alette <i>Tool to increase the thickness of the tabs</i>	spessore 9 mm <i>thickness 9 mm</i>	62	2500
E004000310	Accessorio per aumentare lo spessore delle alette <i>Tool to increase the thickness of the tabs</i>	spessore 10 mm <i>thickness 10 mm</i>	62	2500

* Ogni scatola è composta da 25 confezioni da pz. 100.

* The boxes are made up of 25 x 100 pieces bags.

GRF SYSTEM

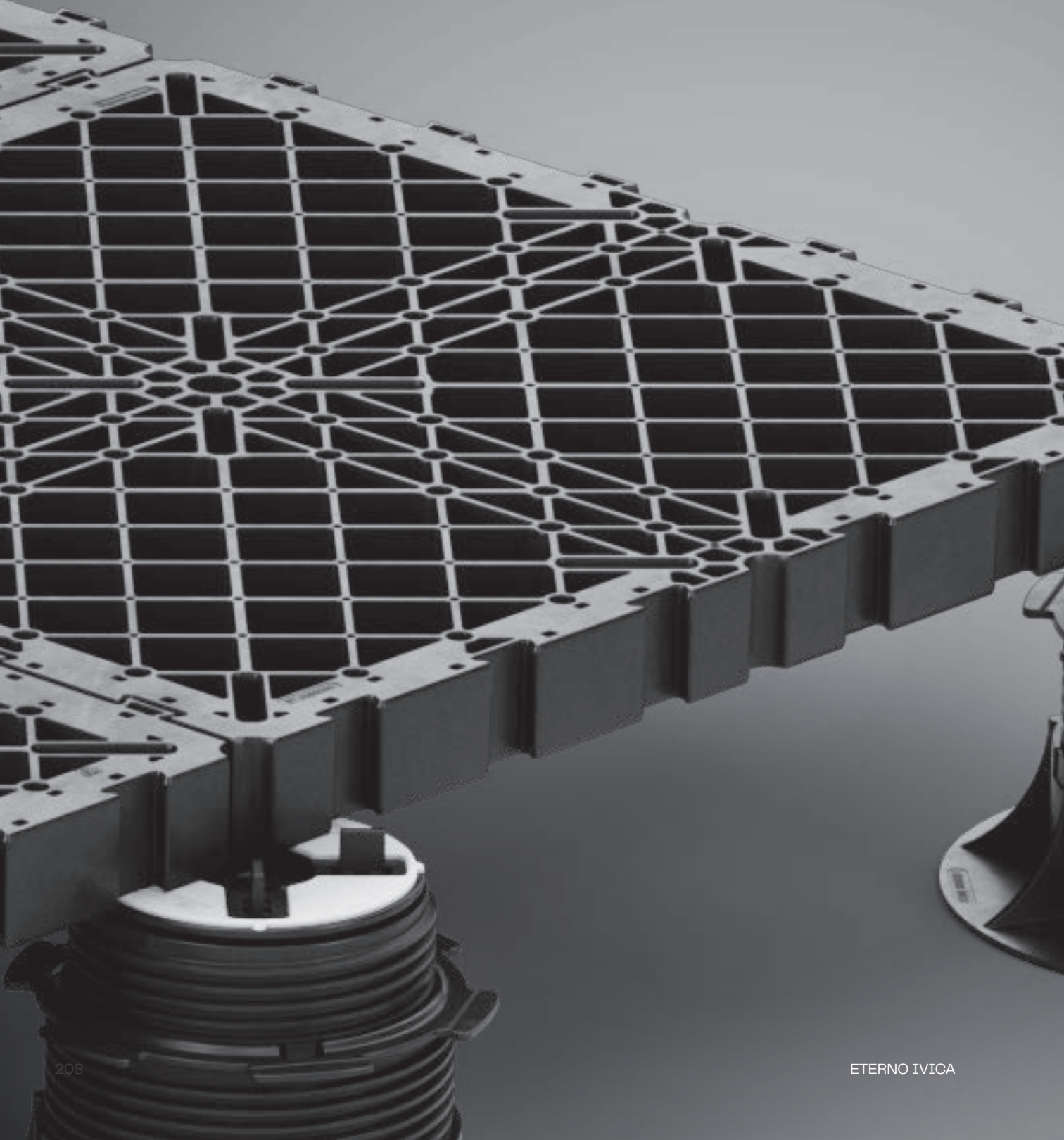

GRID RAISED FLOOR SYSTEM

Posa di pavimentazioni sopraelevate su griglia

Laying raised floor on grid

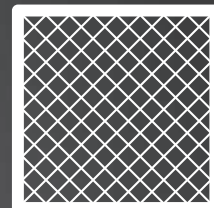

GRF System è il nuovo sistema di posa che ti consente la massima libertà di posa del pavimento sopraelevato. Permette infatti di realizzare una sottostruttura per posare in modo creativo lastre di ceramica (ad esempio a correre, in diagonale, multifornato), realizzare tappeti green di erba sintetica o anche mescolare le due tipologie di posa.

GRF System is the new installation system that provides you with the ultimate freedom to create your raised floor. It allows you to create a substructure for creatively laying ceramic slabs (e.g., in a running bond, diagonal, or multiple formats), install synthetic grass green carpets, or even combine both types of installations.



NOVITÀ
NEWS

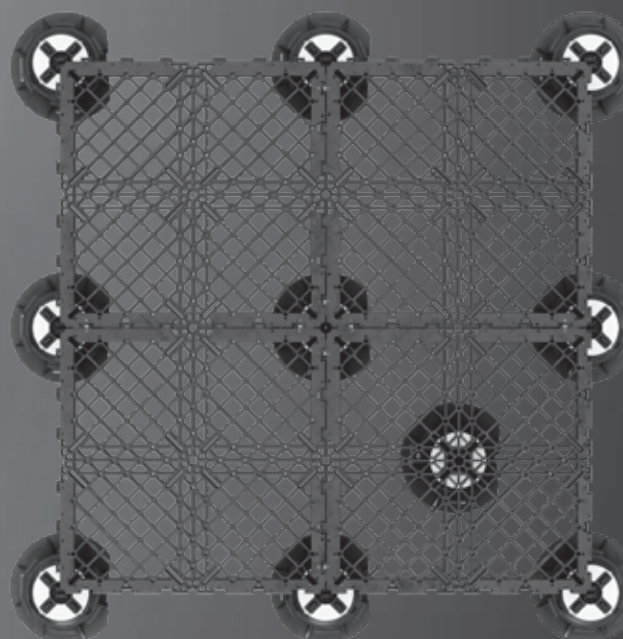





Perché utilizzare GRF System?

Why use GRF System?



Massima libertà di utilizzare lastre con dimensioni e schemi di posa di qualsiasi tipo

Freedom to use slabs of any size and installation patterns

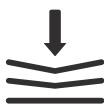

La Griglia ha una struttura progettata per essere resiliente

The grid has a structure designed to be resilient



È un sistema semplice e veloce da posare

It is a simple and fast system to install



Permette di posare tappeti erbosi di erba sintetica

It allows the installation of synthetic grass carpets



Garantisce una maggiore sicurezza nel caso di una pavimentazione sopraelevata di grande altezza

It provides greater safety in the case of a raised flooring of significant height

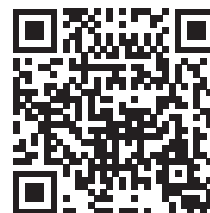

Guarda il video di presentazione



Watch the presentation video

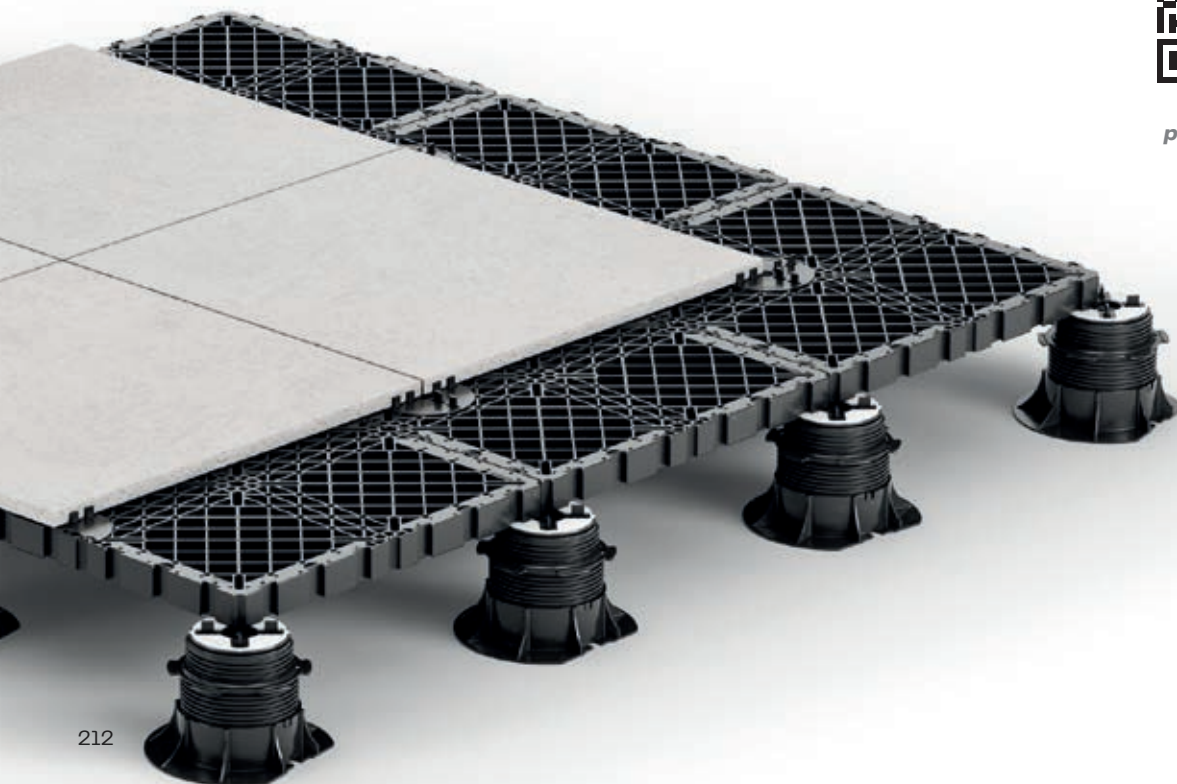

Posa GRF System con ceramica

Laying GRF System with ceramic slabs



Step 01: i supporti

Posizionare i supporti sul piano di posa e regolare l'altezza desiderata. Al fine di migliorare la portata delle griglie è possibile aggiungere un supporto al centro di ogni griglia e/o al centro dei 4 lati.

Step 01: the supports

Place the supports on the installation surface and adjust them to the desired height. To enhance the load-bearing capacity of the grids, it is possible to add a support in the center of each grid and/or at the center of the four sides.

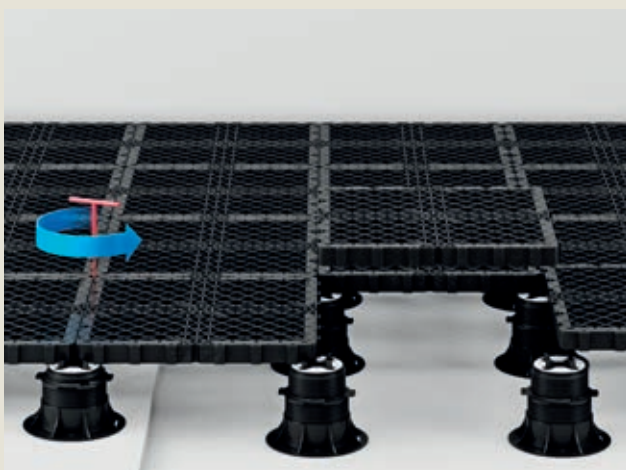

Step 02: le griglie

Appoggiare le griglie sopra i supporti in corrispondenza delle speciali asole predisposte e incastrarle l'un l'altra tramite gli innesti "a coda di rondine".

Effettuare il livellamento millimetrico delle griglie con la chiave di regolazione e la livella a bolla o a laser.

Step 02: the substructure

Place the grids on top of the supports, aligning them with the special slots provided, and interlock them using the "dovetail joint" connections. Achieve precise leveling of the grids using the adjustment key and a bubble or laser level tool.

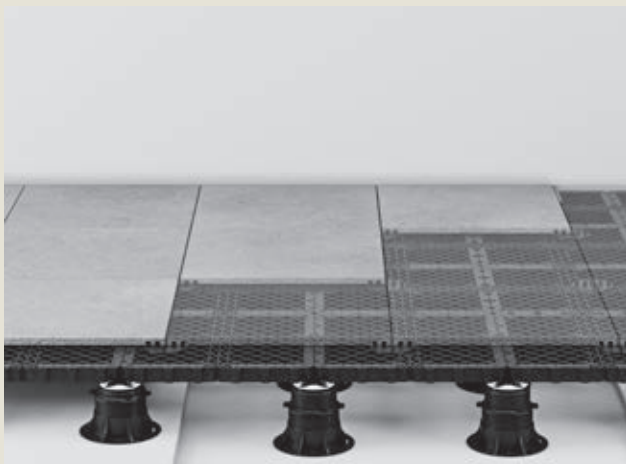

Step 03: la pavimentazione

Posare gli elementi di pavimentazione (gres porcellanato, marmo...) avendo l'accortezza di posizionare al di sotto degli angoli il distanziatore DLG che ha la funzione di creare la "fuga" e allineare gli elementi di pavimentazione. Per il tamponamento verticale si può utilizzare il profilo perimetrale verticale o il profilo bordo lastra abbinato alla clip base.

Step 03: the flooring

Install the flooring elements (porcelain stoneware, marble, etc.), taking care to place the DLG spacer underneath the corners. The spacer serves the purpose of creating gaps and aligning the flooring elements. For vertical sealing, you can use a vertical perimeter profile or a plate edge profile paired with a base clip.

Posa GRF System con erba sintetica

Laying GRF System with synthetic grass

Il sistema di posa sopraelevato GRF SYSTEM è particolarmente indicato per l'applicazione della copertura finale in erba sintetica. Potrai così ottenere una superficie pedonabile del tutto simile all'erba di un prato verde, per realizzare un giardino, una terrazza o una zona di "verde" abbinata magari alla ceramica, un vero e proprio "tetto verde".

I vantaggi di questo sistema sono innumerevoli:

- L'estetica di un vero e proprio prato verde
- Posa rapida e semplice
- Sistema "a secco", senza uso di colla e/o prodotti chimici
- Superficie perfettamente livellata
- Superficie senza ristagni d'acqua, il sistema è drenante
- Il sistema può essere posato su qualsiasi tipo di sottofondo: impermeabile e/o drenante
- Assenza totale di manutenzione
- Risparmio di acqua ed energia elettrica, rispetto ad un prato in erba naturale
- Tutti i componenti del sistema sono riciclabili
- Ampia gamma di accessori per una finitura perfetta: chiusure verticali, distanziatori perimetrali, ecc.

The GRF SYSTEM raised flooring system is particularly suitable for the application of the final covering with synthetic turf. With this system, you can achieve a walkable surface that closely resembles the grass of a green lawn, allowing you to create a garden, a green area combined with ceramic slabs, a terrace, or even a full-fledged "green roof."

The advantages of this system are numerous:

- *The aesthetic appeal of a real green lawn*
- *Quick and simple installation process*
- *"Dry" system without the use of adhesives or chemicals*
- *Perfectly level surface*
- *Water-drainage system, preventing water stagnation*
- *Can be installed on various types of subfloors, whether waterproof or draining*
- *No maintenance required*
- *Water and energy savings compared to natural grass lawns*
- *All system components are recyclable*
- *Wide range of accessories available for a flawless finish, such as vertical closures and perimeter spacers*



Posa mista ceramica ed erba sintetica

Mixed installation of ceramic slabs and synthetic grass

Con il sistema GRF hai la libertà di posare anche una copertura "mista", ceramica + erba, potrai così creare delle zone di erba abbinata ad una pavimentazione in ceramica. La posa è molto semplice, bisogna tenere le due zone (ceramica ed erba) separate, mediante l'utilizzo dello speciale profilo distanziatore a "T".

With the GRF system, you have the freedom to install a "mixed" covering as well, combining ceramic slabs and grass. This way, you can create areas with grass complemented by a ceramic pavement. The installation is straightforward; you need to keep the two areas (ceramic and grass) separated using the special spacer "T" profile.



Step 01: la sottostruttura

La sottostruttura del sistema GRF è composta dai supporti regolabili in altezza e dalle griglie. Una volta definita l'altezza del sistema si sceglie il tipo di supporto. Il numero minimo di supporti a mq è di 4. Il numero di griglie a mq è di 4.

Step 01: the substructure

The substructure of the GRF system consists of height-adjustable supports and grids. Once the desired height of the system is determined, you can choose the type of support. The minimum number of supports per square meter is 4, and the number of grids per square meter is also 4.

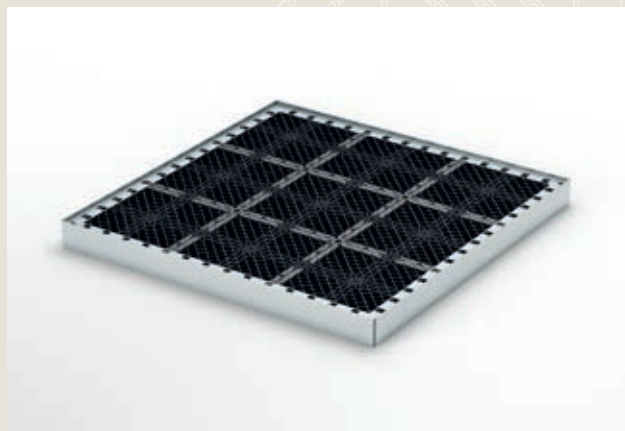

Step 02: il tamponamento verticale

Se il sistema non appoggia ad una parete o non ha alcun contenimento, per il tamponamento verticale è disponibile il "profilo perimetrale verticale".

Step 02: the vertical infill

If the system does not have a wall support or any containment, you can use the "vertical perimeter profile" for vertical sealing.

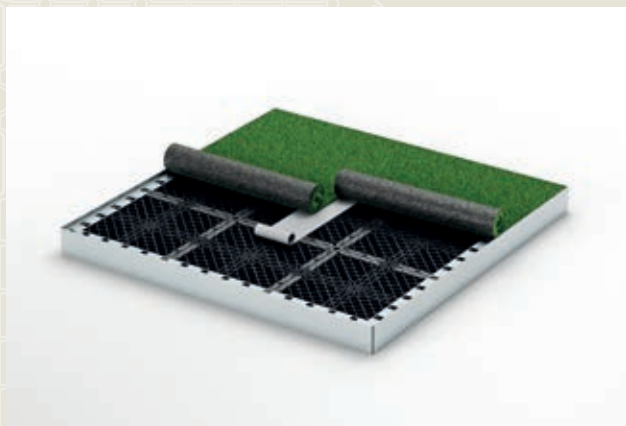

Step 03: l'erba sintetica

La copertura con l'erba sintetica avviene mediante la stesura dei rotoli, una volta allineati e stesi vengono uniti tra di loro mediante una banda di giunzione adesiva, la quale viene inserita al di sotto dei lembi che devi unire.

Step 03: synthetic grass

The synthetic grass covering is done by unrolling the rolls of grass. Once aligned and laid out, they are joined together using an adhesive joining tape, which is inserted underneath the edges that need to be joined.

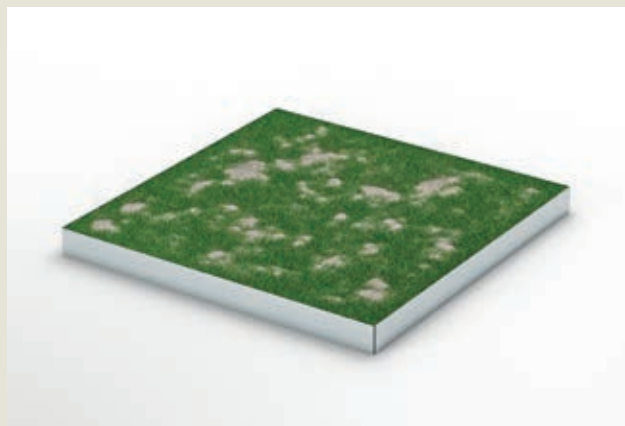

Step 04: l'intasamento con la sabbia

L'ultima operazione è l'intasamento con la sabbia, la quale ha una funzione di stabilizzare l'erba e fungere da zavorra. Deve essere posata in modo uniforme, nella quantità di kg/mq 4/5.

Step 04: clogging with sand

The final step is infilling with sand, which serves to stabilize the grass and provide weight. The sand should be evenly spread, typically at a rate of 4 to 5 kg per square meter.

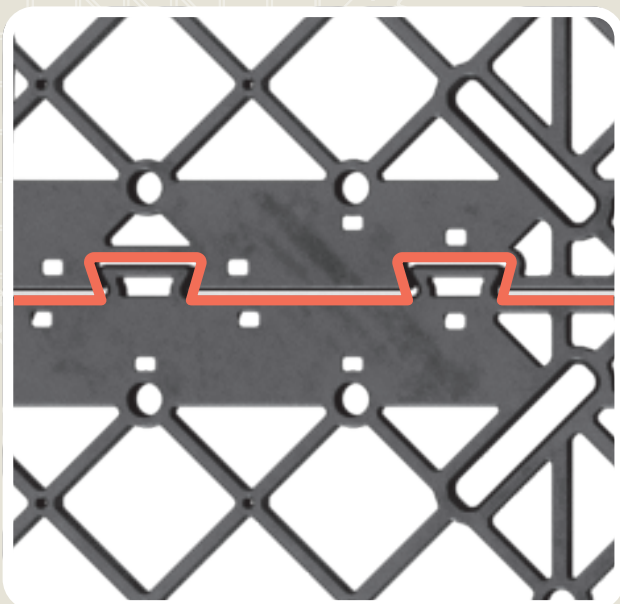

Lo speciale innesto “a coda di rondine” The special “dovetail” joint

Il sistema di innesto tra Griglia e Griglia, appositamente progettato a “coda di rondine”, permette di ottenere una superficie continua, con gli elementi che si uniscono tra di loro in modo semplice e veloce. Non sono necessari altri accessori per unire le Griglie tra di loro.

The interlocking system between the grids, specifically designed with a “dovetail joint,” allows for a continuous surface where the elements seamlessly connect with each other in a simple and fast manner. No additional accessories are required to join the grids together.

Gli elementi del sistema GRF

The elements of GRF System

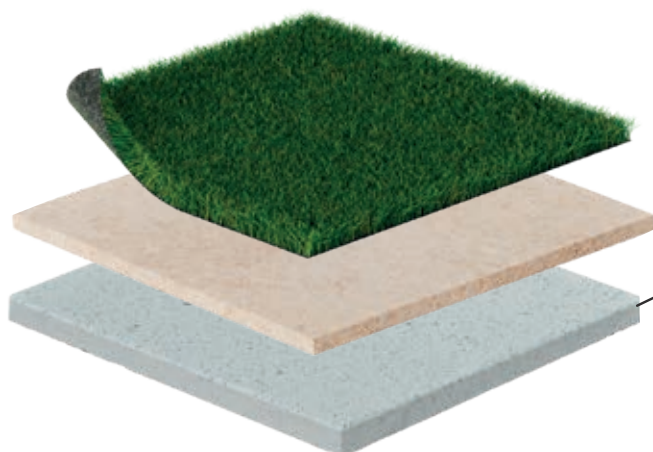

Elemento di finitura superficiale
(ceramica, lastra cementizia, erba sintetica...)
*Surface finishing element
(ceramic, cement slab, synthetic grass...)*



Distanziatore DLG con alette facilmente asportabili H 12 mm,
spessore 2, 3 o 4 mm

DLG spacer with easily removable tabs H 12 mm, thickness 2, 3 or 4 mm

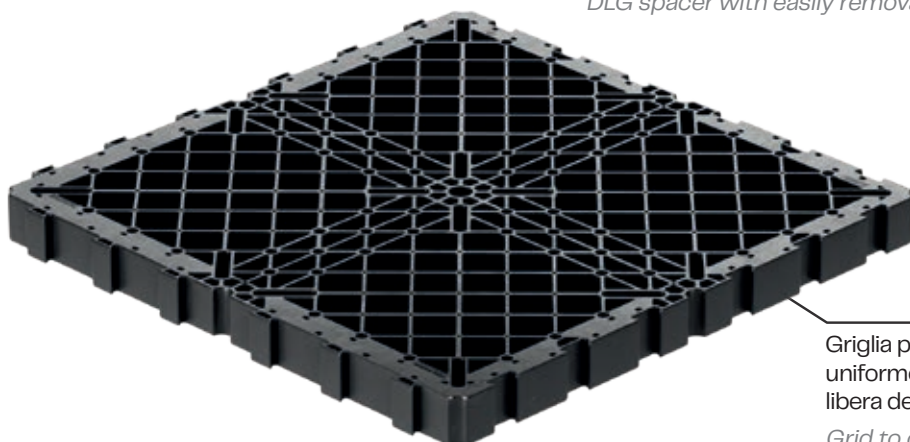

Griglia per creare una superficie stabile,
uniforme e livellata che permette una posa
libera degli elementi di finitura

*Grid to create a stable, uniform and smooth
surface which allows for a free laying
of the finishing elements*



Supporto
Support

Base di cemento 25x25 cm per posa
su sottofondo drenante

Concrete base 25x25 cm for laying on a draining substrate



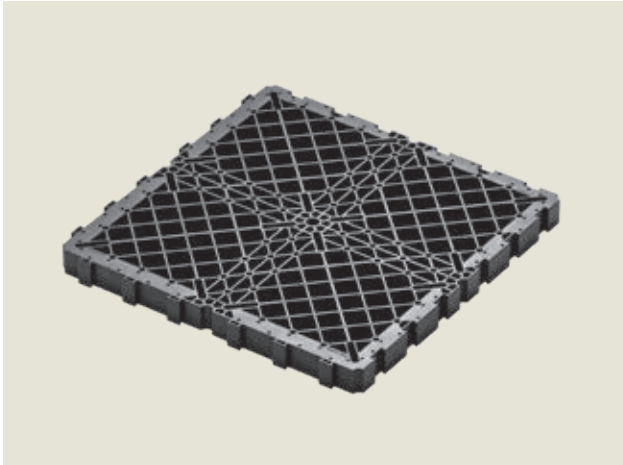

Griglia Grid

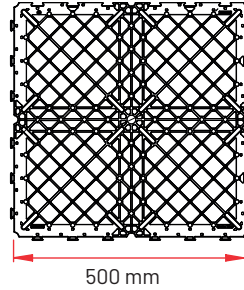

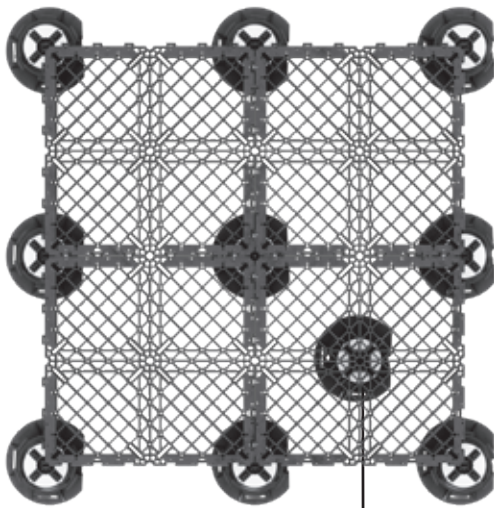

La griglia è l'elemento principale del sistema GRF, è realizzata in Polipropilene, delle dimensioni di 50 x 50 cm x H 4 cm. Le griglie si innestano tra di loro mediante i particolari a "coda di rondine" presenti lungo il perimetro, ottenendo così una superficie continua. Non sono necessari altri accessori per unire le Griglie tra di loro.

The grid is the main component of the GRF system and is made of Polypropylene. It has dimensions of 50 cm x 50 cm x 4 cm (height). The grids interlock with each other using the dovetail joints along the perimeter, creating a seamless surface. No additional accessories are required to join the grids together.

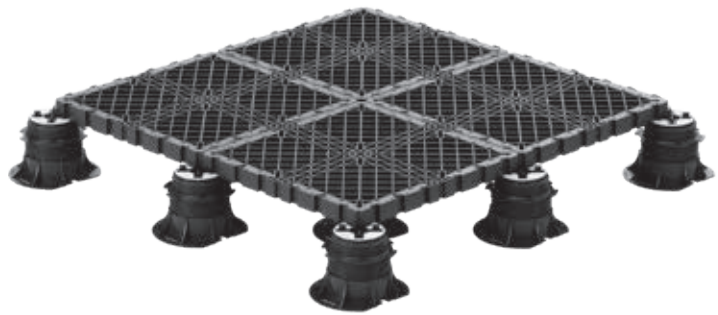

Opzionale
Optional



CODICE CODE	DESCRIZIONE DESCRIPTION	MISURA SIZE	PAG. LISTINO PRICE LIST PAGE	PZ 
P021305050	Griglia in PP <i>PP grid</i>	500 x 500 mm H 40 mm	66	200



Distanziatore DLG

DLG spacer

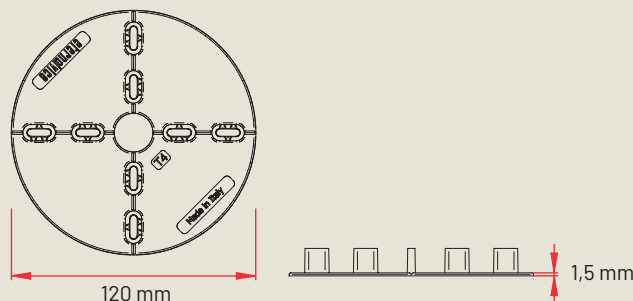

Il distanziatore DLG si utilizza nel caso di una copertura con elementi quali ad esempio ceramica o lastra cementizia. Viene posizionato nell'incrocio degli elementi di copertura, in modo da distanziarli ed allinearli tra di loro. Le alette, che sono facilmente asportabili, hanno lo spessore di 4 mm (standard), 2 e 3 mm, H 12 mm, lo spessore del DLG è di 1,5 mm.

The DLG spacer is used in cases where the covering elements, such as ceramic slabs or cement slabs, are being installed. It is placed at the intersection of the covering elements to create spacing and alignment between them. The removable tabs of the spacer have a standard thickness of 4 mm, but there are also options available with thicknesses of 2 mm and 3 mm, H 12 mm, the thickness of the DLG is 1,5 mm.



Esempi di posizionamento lastre con distanziatore DLG.



Examples of slab positioning with DLG spacer.

CODICE CODE	DESCRIZIONE DESCRIPTION	ALETTA TAB	DIMENSIONI DIMENSIONS	PAG. LISTINO PRICE LIST PAGE	PZ
E004002002	Distanziatore per lastre su griglia <i>DLG spacer for ceramic slabs on grid</i>	Sp. 2 mm H 12 mm	Sp. 1,5 mm Ø 120 mm	66	100
E004002003	Distanziatore per lastre su griglia <i>DLG spacer for ceramic slabs on grid</i>	Sp. 3 mm H 12 mm	Sp. 1,5 mm Ø 120 mm	66	100
E004002004	Distanziatore per lastre su griglia <i>DLG spacer for ceramic slabs on grid</i>	Sp. 4 mm H 12 mm	Sp. 1,5 mm Ø 120 mm	66	100

Consumo dei distanziatori DLG al metro quadro

DLG spacers consumption per square meter

MISURA LASTRE SLABS SIZE	20	30	40	45	50	60	70	75	80	90	100
20	25	16,67	12,5	11,11	10	8,33	14,29	13,33	12,5	11,11	10
30	16,67	11,11	8,33	7,41	6,67	5,56	9,52	8,89	8,33	7,41	6,67
40	12,5	8,33	6,5	5,56	5	4,17	7,14	6,67	6,65	5,56	5
45	11,1	7,41	5,56	4,94	4,44	3,7	6,35	5,63	5,56	4,94	4,44
50	10	6,67	5	4,44	4	3,33	5,71	5,33	5	4,44	4
60	8,3	5,56	4,17	3,7	3,33	2,78	4,76	4,44	4,17	3,7	3,33
70	14,29	9,52	7,14	6,35	5,71	4,76	4,08	3,81	3,57	3,17	2,86
75	13,33	8,89	6,67	5,93	5,33	4,44	3,81	3,56	3,33	2,96	2,67
80	12,5	8,33	6,25	5,56	5	4,17	3,57	3,33	6,25	5,56	5
90	11,11	7,41	5,56	4,94	4,44	3,7	3,17	2,96	5,56	4,94	4,44
100	10	6,67	5	4,44	4	3,33	2,86	2,67	5	4,44	4
120	8,33	5,56	4,17	3,7	3,33	2,78	2,38	2,22	4,17	3,7	3,33
140	14,29	9,52	7,14	6,35	5,71	4,76	2,04	1,9	3,57	3,17	2,86
160	12,5	8,33	6,25	5,56	5	4,17	3,57	3,33	6,25	5,56	5
180	8,33	5,56	4,17	3,7	3,33	2,78	2,38	2,22	4,17	3,7	3,33

Consumo di supporti al metro quadro

Consumption of supports per square meter

MISURA GRIGLIA GRID SIZE	NUMERO SUPPORTI NUMBER OF SUPPORTS	NUMERO SUPPORTI CON UN SUPPORTO DI RINFORZO AL CENTRO NUMBER OF SUPPORTS WITH ONE CENTER REINFORCEMENT SUPPORT
50 x 50	4	8

NB: questa tabella è un puro calcolo matematico e non tiene conto di tutte le variabili di cantiere pertanto i valori di consumo sono indicativi e vi invitiamo ad aumentare i valori sopra indicati del 5 - 15 %.

Consigliamo di rivolgersi sempre ai nostri tecnici.

NB: this table is a pure mathematical calculation and does not take into account all the site variables, so the consumption values are indicative and we recommend to increase the above values by 5-15%.

We always suggest increasing contacting our specialists.

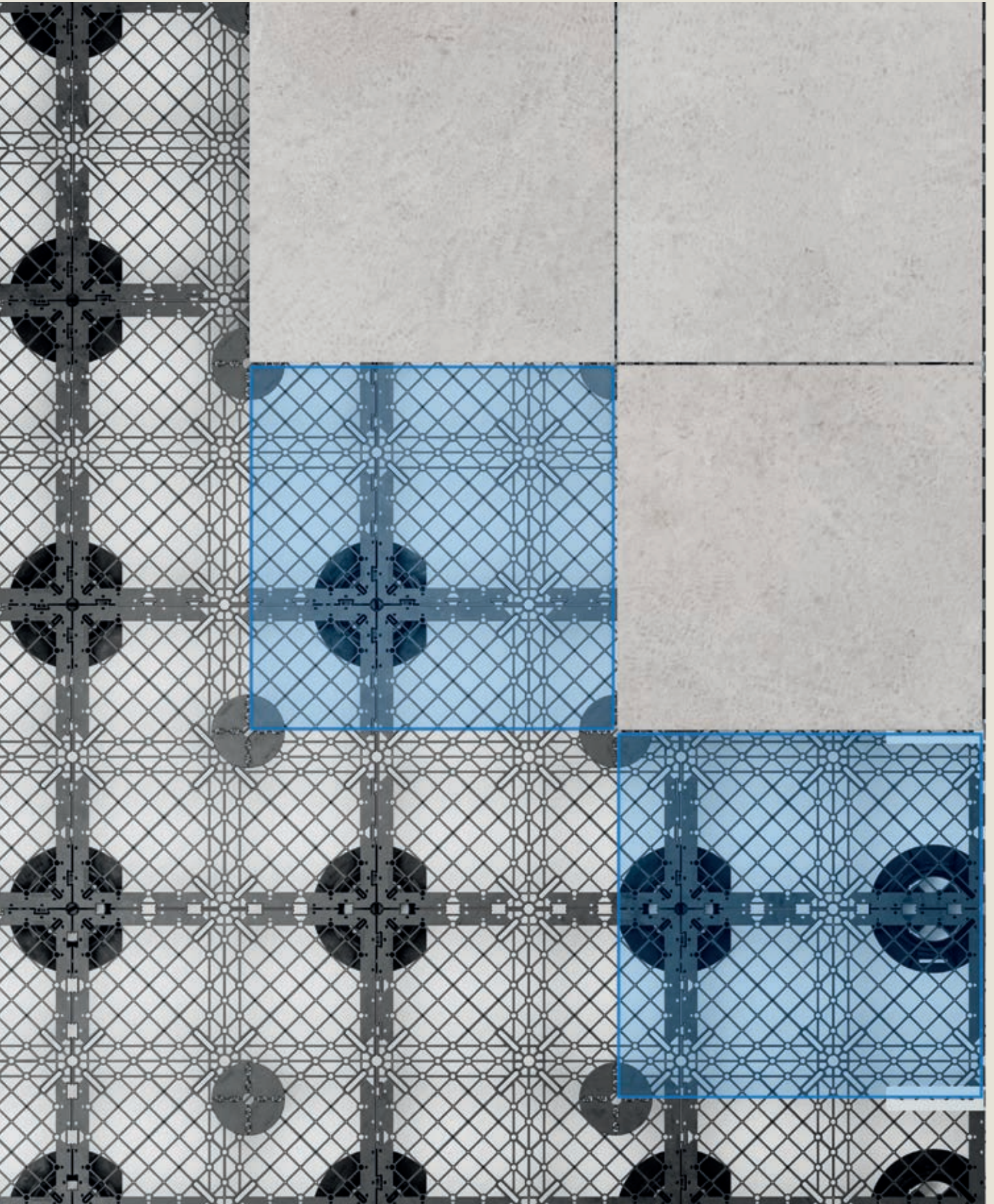



Profilo bordo lastra

Slab edge profile

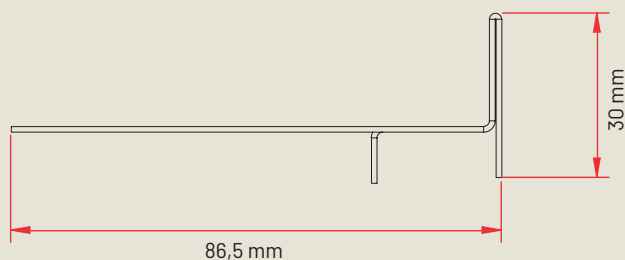

Il profilo Bordo Lastra di Eterno Ivica è pensato per delimitare i bordi perimetrali di un pavimento sopraelevato in corrispondenza di un rivestimento verticale. Il Profilo Bordo Lastra ha pertanto una parte a vista decorativa di 30 mm e un dente posteriore che va a mantenere in posizione verticale le lastre perimetrali. Disponibili in acciaio inox spazzolato sp. 1 mm e alluminio sp. 1,5 mm. Il tutto per garantire un effetto estetico a regola d'arte.

The slab edge profile by Eterno Ivica is designed to limit the raised floor's edges in correspondence with a vertical covering. The slab edge profile has a 30 mm decorative part and a tooth overlapped to the vertical slab in order to hide the junction with the floor.

It is available in stainless steel (IS) 1 mm thick and aluminium 1,5 mm thick. Everything is made up to guarantee a state-of-the-art aesthetic result.

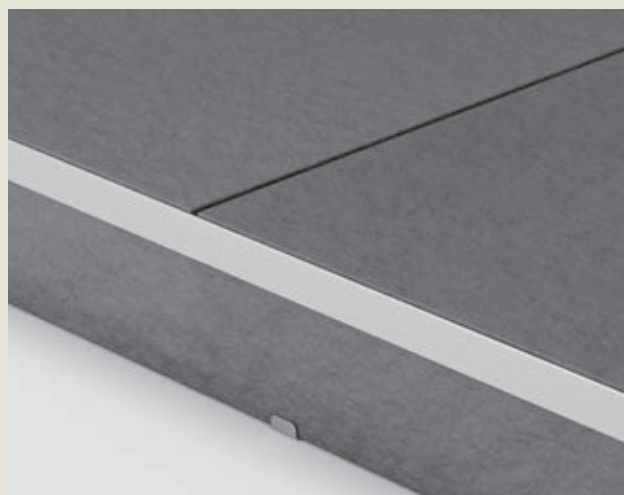
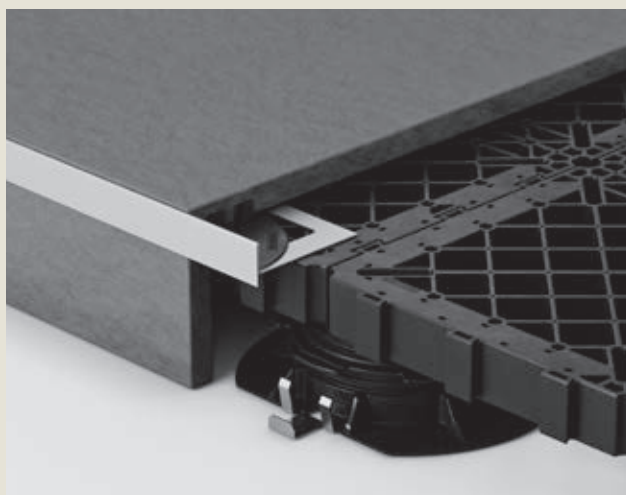

Nella posa con GRF System questo prodotto è abbinato alla clip tamponamento verticale (base).

In the installation with the GRF System, this product is paired with the vertical lining clip (base).

CODICE CODE	DESCRIZIONE DESCRIPTION	MISURA SIZE	PAG. LISTINO PRICE LIST PAGE	PZ 	PZ
P021200020	Profilo bordo lastra acciaio inox <i>Stainless steel slab edge profile</i>	1,20 mt	66	-	-
P021200120	Profilo bordo lastra alluminio <i>Aluminium slab edge profile</i>	1,20 mt	66	-	-

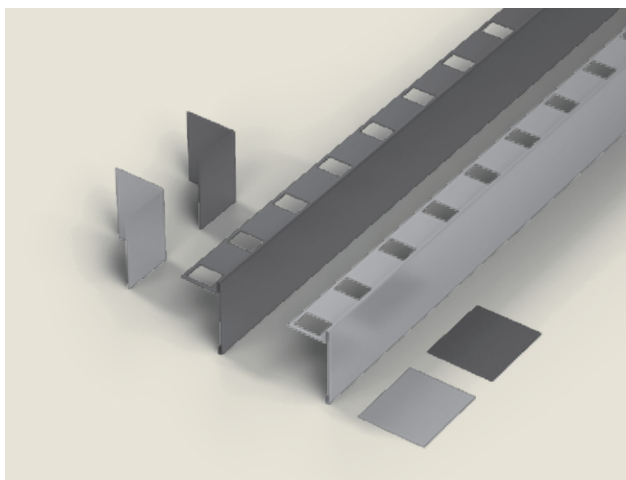

Profilo perimetrale verticale

Vertical perimeter profile

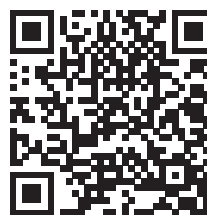

**Guarda il video
di presentazione**



**Watch the
presentation video**

Il Profilo Perimetrale Verticale è un elemento di chiusura e finitura dei bordi perimetrali nelle pavimentazioni so-praelevate esterne, si adatta perfettamente alle lastre di pavimentazione dello spessore di 20 mm e ai supporti che fungono da sottostruttura.

È un prodotto che combina l'estetica con la funzionalità e rende ancora più gradevole una pavimentazione esterna.

Il profilo è in alluminio e viene proposto in due colori standard: silver e grigio antracite; è corredato di due importanti accessori che sono il giunto lineare e il giunto angolare a 90°, anch'essi in alluminio e con le medesime colorazioni del profilo. Il profilo ha una lunghezza di 2,40 m mentre le altezze standard sono di 30-60-90-120-150 mm.

Di facile e veloce installazione, è sufficiente appoggiare il lato con le feritoie sulle teste dei supporti, accostare i profili e inserire i giunti (lineare e ad angolo).

The Vertical Perimeter Profile is an element of closure and finishing of the perimeter edges in the external raised flooring, it adapts perfectly to the flooring slabs of 20 mm thickness and to the supports that act as a substructure. It is a product that combines aesthetics with functionality and makes an outdoor flooring even more pleasant.

The profile is in aluminium and is available in two standard colours: silver and anthracite gray. It is equipped with two important accessories that are the linear joint and the 90° angular joint, also in aluminium and with the same colours of the profile.

The profile has a length of 2.40 meters while the standard heights are 30-60-90-120-150 mm. Easy and quick to install, simply place the side with the slits on the heads of the supports, pull together the profiles and insert the joints (linear and angular).

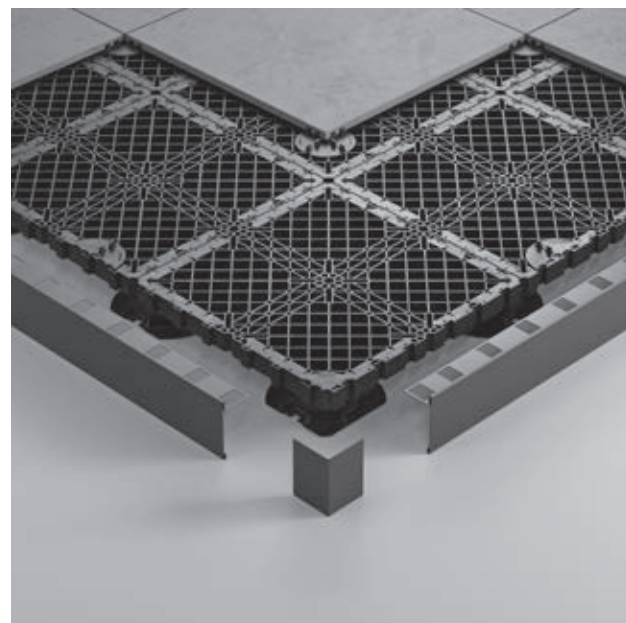



Giunto lineare
Linear joint



Posizionamento profilo sui supporti
Positioning of the profile on the supports

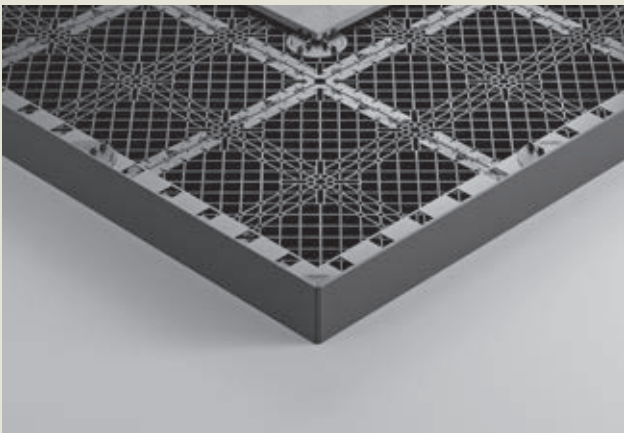

Angolo esterno
External corner

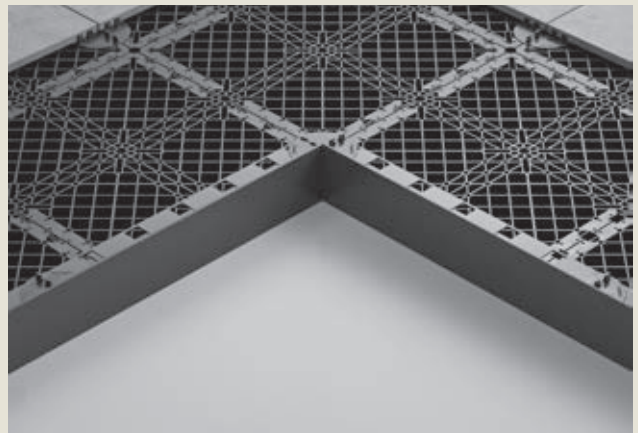

Angolo interno
Internal corner

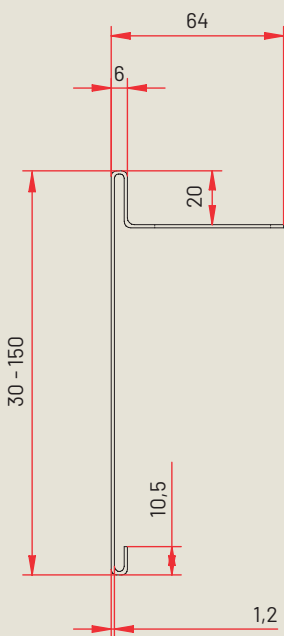

Le misure sono espresse in millimetri.

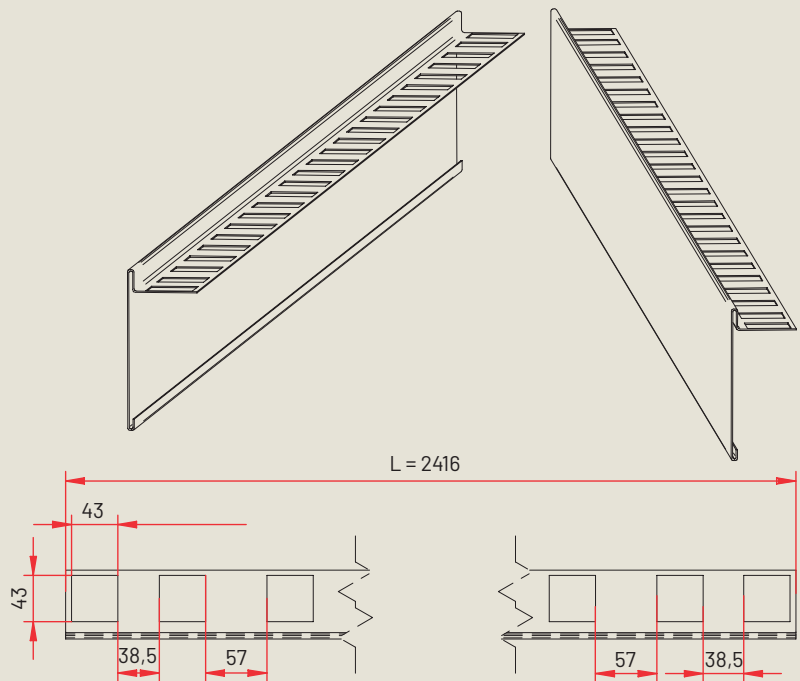

Measurements are expressed in millimeters.

CODICE CODE	COLORE COLOR	DESCRIZIONE DESCRIPTION	ALTEZZA HEIGHT H	LAR- GHEZZA LENGHT L	PAG. LISTINO PRICE LIST PAGE	PZ 
P021241030	Silver	Profilo perimetrale verticale <i>Vertical perimeter profile</i>	30 mm	2400 mm	67	10
P021251030	Antracite <i>Anthracite</i>					
P021241060	Silver	Profilo perimetrale verticale <i>Vertical perimeter profile</i>	60 mm	2400 mm	67	10
P021251060	Antracite <i>Anthracite</i>					
P021241090	Silver	Profilo perimetrale verticale <i>Vertical perimeter profile</i>	90 mm	2400 mm	67	5
P021251090	Antracite <i>Anthracite</i>					
P021241120	Silver	Profilo perimetrale verticale <i>Vertical perimeter profile</i>	120 mm	2400 mm	67	5
P021251120	Antracite <i>Anthracite</i>					
P021241150	Silver	Profilo perimetrale verticale <i>Vertical perimeter profile</i>	150 mm	2400 mm	67	5
P021251150	Antracite <i>Anthracite</i>					
P021242030	Silver	Angolo 90° <i>90° angle</i>	30 mm	-	67	1
P021252030	Antracite <i>Anthracite</i>					
P021242060	Silver	Angolo 90° <i>90° angle</i>	60 mm	-	67	1
P021252060	Antracite <i>Anthracite</i>					
P021242090	Silver	Angolo 90° <i>90° angle</i>	90 mm	-	67	1
P021252090	Antracite <i>Anthracite</i>					
P021242120	Silver	Angolo 90° <i>90° angle</i>	120 mm	-	67	1
P021252120	Antracite <i>Anthracite</i>					
P021242150	Silver	Angolo 90° <i>90° angle</i>	150 mm	-	67	1
P021252150	Antracite <i>Anthracite</i>					
P021243030	Silver	Giunto lineare <i>Linear joint</i>	30 mm	-	67	1
P021253030	Antracite <i>Anthracite</i>					
P021243060	Silver	Giunto lineare <i>Linear joint</i>	60 mm	-	67	1
P021253060	Antracite <i>Anthracite</i>					
P021243090	Silver	Giunto lineare <i>Linear joint</i>	90 mm	-	67	1
P021253090	Antracite <i>Anthracite</i>					
P021243120	Silver	Giunto lineare <i>Linear joint</i>	120 mm	-	67	1
P021253120	Antracite <i>Anthracite</i>					
P021243150	Silver	Giunto lineare <i>Linear joint</i>	150 mm	-	67	1
P021253150	Antracite <i>Anthracite</i>					

Clip tamponamento verticale (base) Vertical lining clip (base)



Progettata per far fronte a un problema comune a tante pavimentazioni esterne, ovvero il tamponamento del bordo quando si è in assenza del muro perimetrale, le clip per tamponamento verticale costituiscono un innovativo sistema che permette di chiudere facilmente ed elegantemente lo spazio perimetrale che si crea in presenza di pavimentazioni sopraelevate.

Una soluzione composta da una clip in acciaio inox che, posizionata sotto la base del supporto (in abbinata al profilo bordo lastra), crea una sede con dei mordenti che incastrano la porzione di pavimentazione rifilata a misura dello spazio da tamponare, evitando in modo contestuale lo scivolamento delle lastre orizzontali grazie al blocco posto all'estremità della clip. La disposizione di questo sistema permette di realizzare anche dei gradini.

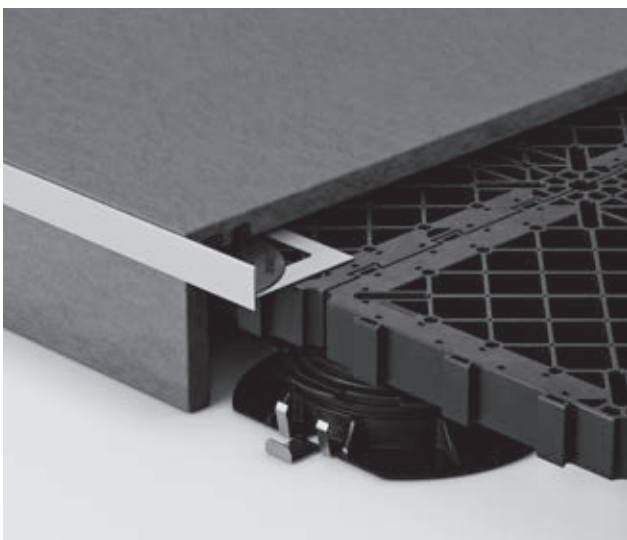

Nella posa con GRF System questo prodotto è abbinato al profilo bordo lastra.



Designed to address a common issue faced with many outdoor floorings, which is the gap left when there is no perimeter wall, the vertical sealing clips are an innovative system that allows for easy and elegant closure of the perimeter space that arises with raised floorings.

This solution consists of a stainless steel clip, positioned under the base of the support (in combination with the slab edge profile), creating a seat with gripping elements that secure the trimmed portion of the flooring to fit the gap, simultaneously preventing the horizontal slabs from slipping due to the block placed at the end of the clip. This arrangement also allows for the creation of steps or stairs.

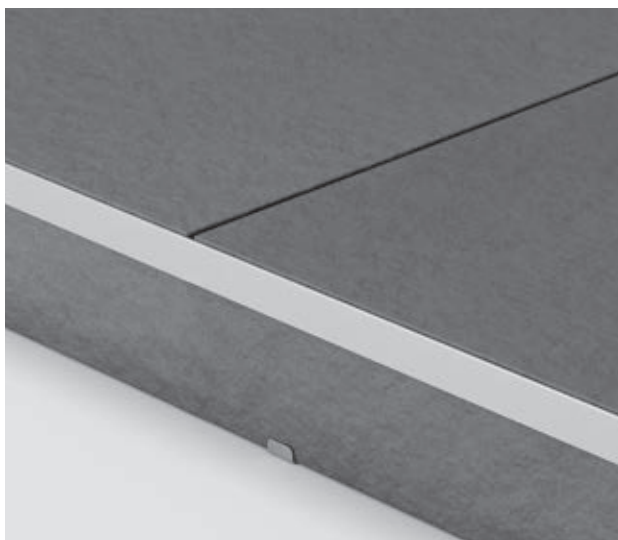

In the installation with the GRF System, this product is paired with the slab edge profile.

CODICE CODE	DESCRIZIONE DESCRIPTION	COMPATIBILITÀ SUPPORTI COMPATIBILITY SUPPORTS	Ø TESTA SUPPORTI Ø HEAD OF SUPPORTS	SPESSORE LASTRA SLAB THICKNESS	PAG. LISTINO PRICE LIST PAGE	PZ 
P021000322	Clip base <i>Base clip</i>	NM con base a rottura facilitata <i>NM with easy break base</i>	110/150 mm	20 mm	68	100
		SE - NM - SB	110 mm			
		PR - SR/SRT	110/150 mm			
P021000352	Clip base <i>Base clip</i>	SE - NM	150 mm	20 mm	68	100
P021000323	Clip base <i>Base clip</i>	NM con base a rottura facilitata <i>NM with easy break base</i>	110/150 mm	30 mm	68	100
		SE - NM - SB	110 mm			
		PR - SR/SRT	110/150 mm			
P021000353	Clip base <i>Base clip</i>	SE - NM	150 mm	30 mm	68	100
P021000324	Clip base <i>Base clip</i>	NM con base a rottura facilitata <i>NM with easy break base</i>	110/150 mm	40 mm	68	100
		SE - NM - SB	110 mm			
		PR - SR/SRT	110/150 mm			
P021000354	Clip base <i>Base clip</i>	SE - NM	150 mm	40 mm	68	100

Clip tamponamento verticale angolare (base)

Vertical angular lining clip (base)



Questa particolare clip di base viene impiegata nel caso di un tamponamento verticale ad "angolo": anziché utilizzare due clip di base si utilizza una unica clip di base. È realizzata in acciaio inox, semplice e veloce da installare. Grazie a questo sistema è possibile realizzare anche dei gradini. Si abbina al profilo bordo lastra.

This special base clip is used in the case of a vertical "corner" sealing: instead of using two base clips, a single one is employed. It is made of stainless steel, simple, and quick to install. Thanks to this system, it is possible to create steps or stairs. It complements the slab edge profile.

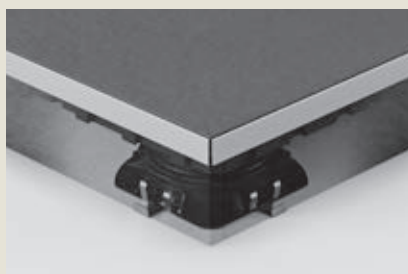
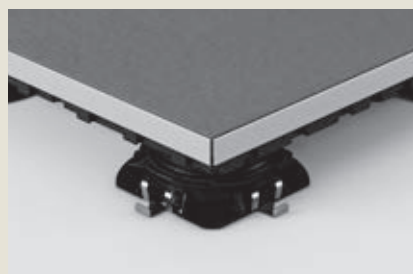

Nella posa con GRF System questo prodotto è abbinato al profilo bordo lastra.

In the installation with the GRF System, this product is paired with the slab edge profile.

CODICE CODE	DESCRIZIONE DESCRIPTION	COMPATIBILITÀ SUPPORTI COMPATIBILITY SUPPORTS	Ø TESTA SUPPORTI Ø HEAD OF SUPPORTS	SPESSORE LASTRA SLAB THICKNESS	PAG. LISTINO PRICE LIST PAGE	PZ
P021000912	Clip base <i>Base clip</i>	PR - SR/SRT - NM con base a rottura facilitata <i>PR - SR/SRT - NM with easy break base</i>	110/150 mm	20 mm	69	25
		SE - NM - SB	110 mm			
		PR	150 mm			
P021000922	Clip base <i>Base clip</i>	SE - NM	150 mm	20 mm	69	25

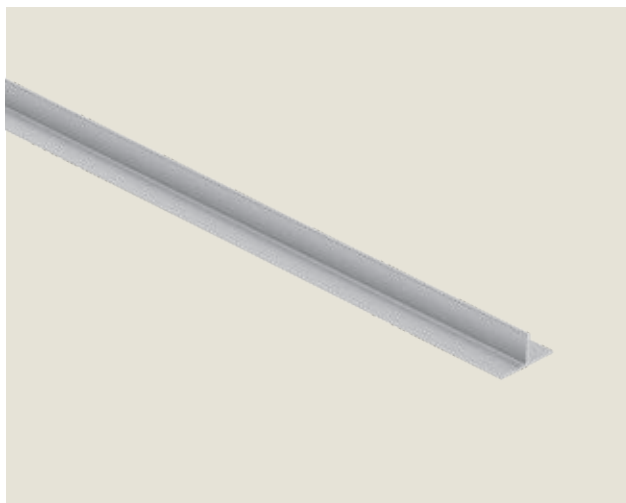

Profilo separatore a "T"



"T" separator profile

Il profilo separatore a "T" è un elemento che viene posato sulla griglia al fine di dividere la superficie ricoperta da ceramica da quella ricoperta da erba sintetica, ha anche la funzione di bloccare e contenere le lastre di ceramica. Il profilo è in alluminio, ha una lunghezza di 2,00 mt, spessore 2 mm, base 40 mm e altezza 20 mm. Può essere fissato alle griglie mediante viti autoperforanti da 3,9 mm x H 19 mm, avendo l'accortezza di avvitarle alla griglia dalla parte dell'erba sintetica.

The "T" separator profile is an element that is placed on the grid in order to divide the surface covered with ceramic slabs from the area covered with synthetic grass. It also serves the function of locking and containing the ceramic slabs. The profile is made of aluminum, with a length of 2,00 meters, a thickness of 2 mm, a base of 40 mm, and a height of 20 mm. It can be fixed to the grids using self-drilling screws measuring 3,9 mm x H 19 mm, taking care to screw them into the grid from the synthetic grass side.

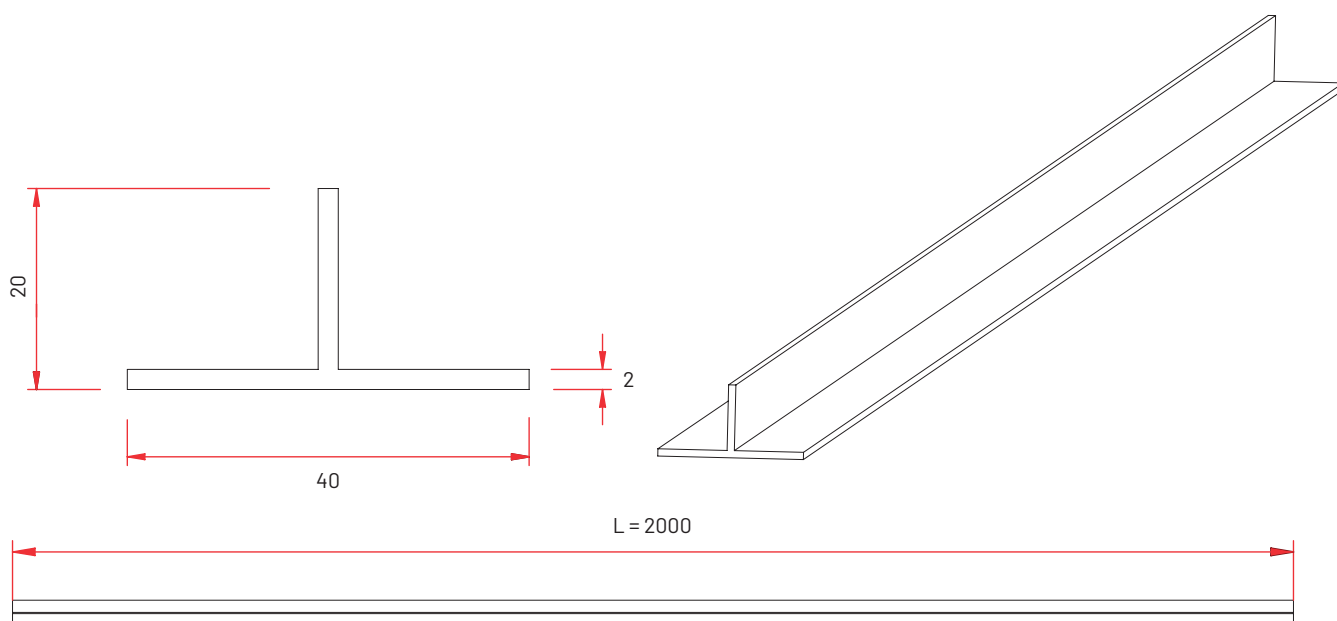

Le misure sono espresse in millimetri.

Measurements are expressed in millimeters.

CODICE CODE	DESCRIZIONE DESCRIPTION	MISURA SIZE	MATERIALE MATERIAL	PAG. LISTINO PRICE LIST PAGE	PZ 
Q231500020	Profilo separatore a "T" "T" separator profile	L 2 mt - H 20 mm	Alluminio Aluminium	68	1

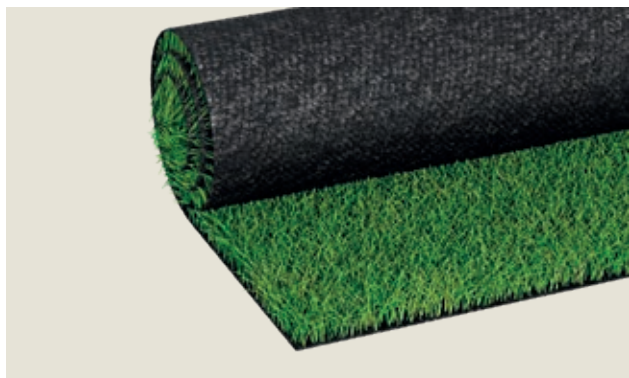

Rotolo di erba sintetica

Synthetic grass



Questa erba sintetica è stata appositamente progettata per essere utilizzata in alternativa all'erba naturale. Il particolare colore dei fili la rendono perfettamente simile all'erba naturale.

This synthetic grass has been specifically designed as an alternative to natural grass. The unique color of the fibers makes it perfectly resemble natural grass.

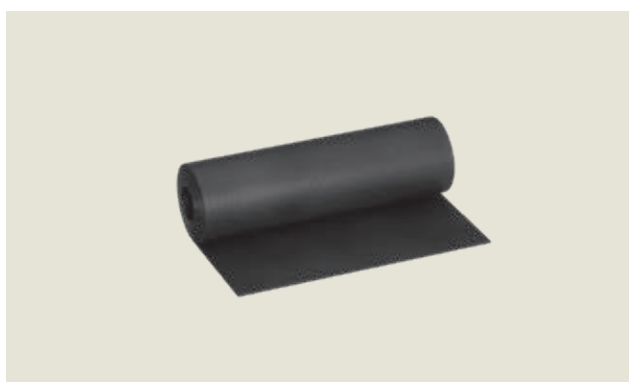

Banda di giunzione adesiva

Adhesive joining tape



La banda di giunzione è adesiva da un lato, in modo da unire perfettamente i due lembi dei rotoli.

The joining tape is adhesive on one side, allowing for a seamless connection between the two edges of the grass rolls.



Sabbia silicea

Silica sand



La sabbia per intasare i fili dell'erba sintetica è fornita in comodi sacchi da kg 25.

The sand for infilling the synthetic grass fibers is provided in convenient 25 kg bags.

CODICE CODE	DESCRIZIONE DESCRIPTION	MISURA SIZE	CONSUMO CONSUMPTION	PAG. LISTINO PRICE LIST PAGE	PZ 	PZ 
V13028015	Erba sintetica in rotoli spessore 50 mm <i>Synthetic turf in rolls with a thickness of 50 mm</i>	L 15 mt H 2 mt	-	69	1 rotolo <i>1 roll</i>	5 rotoli <i>5 rolls</i>
V13028050	Banda di giunzione adesiva H 15 cm <i>Adhesive joining tape H 15 cm</i>	L 10 mt	-	69	4 rotoli <i>4 rolls</i>	-
W160210000	Sabbia silicea <i>Silica sand</i>	25 kg/ sacco <i>25 kg/bag</i>	4-5 kg/m ²	69	1 sacco <i>1 bag</i>	60 sacchi <i>60 bags</i>

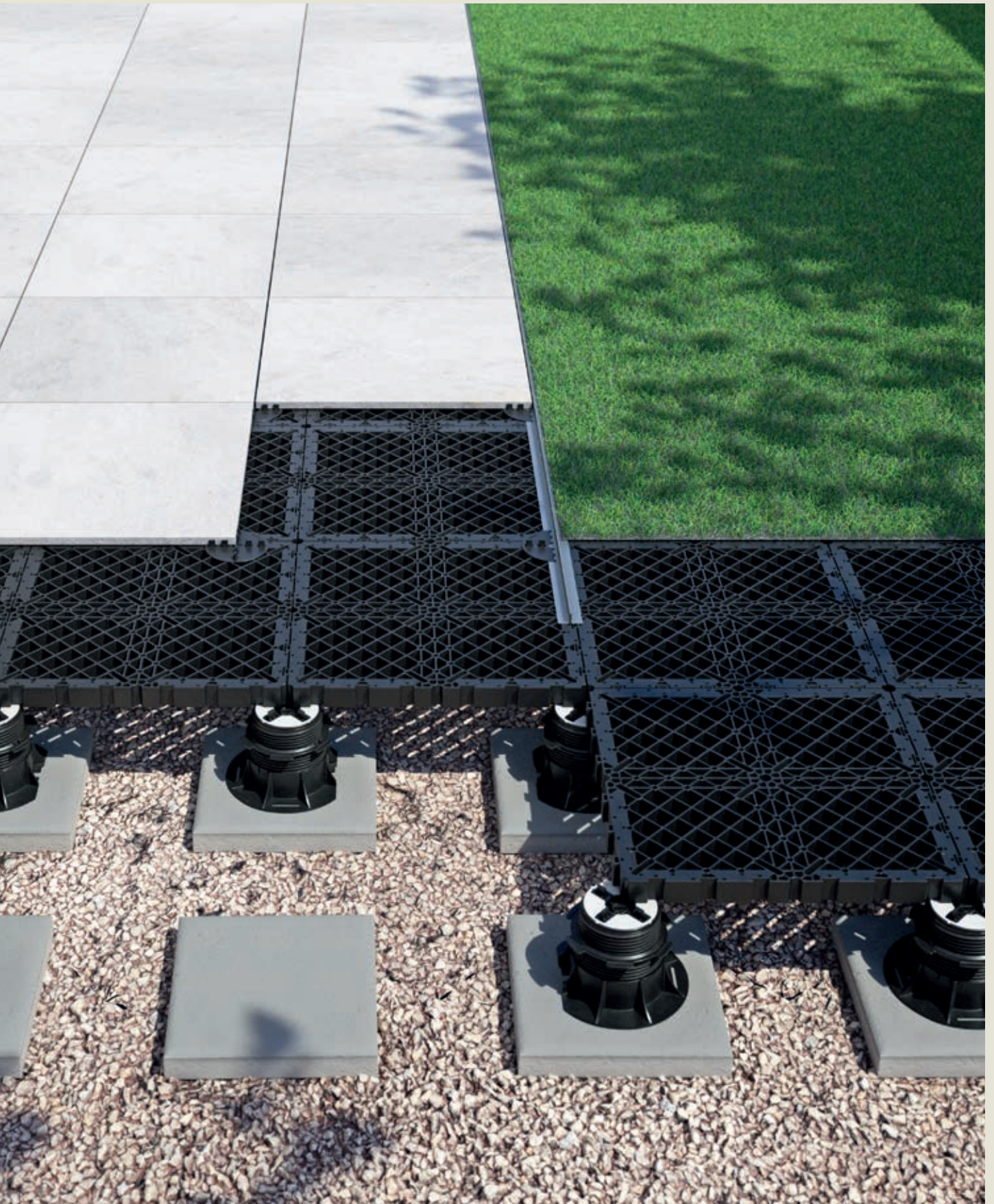



WOODECK SYSTEM

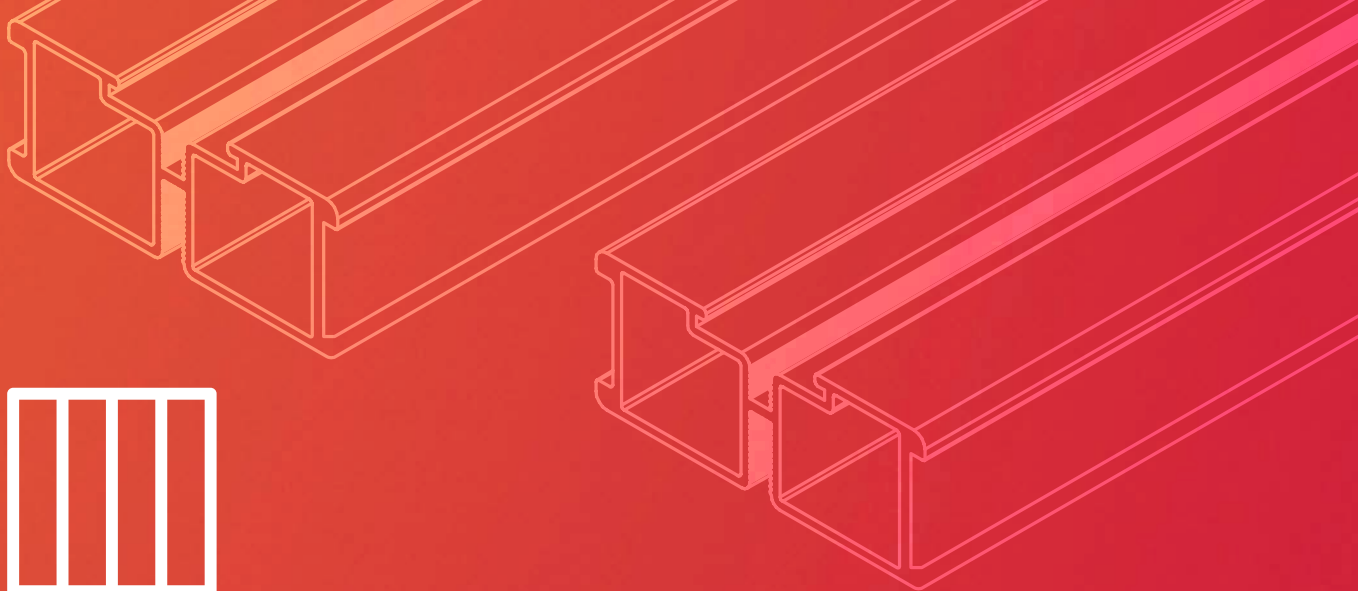

Posa di pavimentazioni
sopraelevate su travetto
di alluminio e legno

Laying raised floor
on aluminium/wooden joist

Perché utilizzare Woodeck System?

Why use Woodeck System?



Il sistema che unisce estetica e funzionalità
The system that combines aesthetics and functionality



Sistema adatto ad ogni tipo di lastra o listone
System suitable for every type of slab or plank



Un sistema corredato da una gamma di accessori per ogni esigenza
A system accompanied by a range of accessories for every need



Un sistema modulare che si adatta ad ogni spazio ed esigenza
A modular system that adapts to every space and requirement



Un sistema che garantisce la massima stabilità della pavimentazione
A system that ensures maximum stability of the flooring

Woodeck System è la soluzione definitiva, progettata e testata per garantire una pavimentazione stabile e duratura, con supporti in grado di portare a diverse quote di elevazione ogni tipo di lastre e listoni: ceramica, legno, WPC, plastica e materiale composito autoportante.

Woodeck è un sistema completo di supporti e travetti in alluminio corredati da speciali clip, che permette di creare un vero pavimento sopraelevato in lastre e listoni. I supporti della linea Woodeck possono essere dotati anche di una testa studiata per accogliere qualsiasi tipologia di travetto in legno o altro materiale.

Un'autentica rivoluzione sia per i posatori, che ne apprezzeranno la semplicità e velocità di posa, sia per gli utilizzatori, che potranno godersi la piacevolezza del risultato estetico e funzionale.

Woodeck System is the ultimate solution, designed and tested to ensure a stable and lasting flooring, with supports capable of bringing every kind of slab and plank to different height elevations: ceramic, wood, WPC, plastic and self-supporting composite material.

Woodeck is a comprehensive system supports and aluminium joists accompanied by special clips that allows you to create a true raised floor with slabs and planks. The Woodeck supports can also be equipped with a head designed to accommodate any type of joist in wood or other material.

A revolution for both the installers, who will appreciate the simplicity and speed of laying, as well as for the users, who can enjoy the pleasantness of an aesthetic and functional result.



Tipologie di testa per Woodeck System

Types of head for Woodeck System

Un sistema completo e versatile per la posa di lastre e listoni con diverse tipologie di testa per rispondere a tutte le esigenze costruttive.

Il sistema Woodeck prevede varie tipologie di testa per il sostegno della sottostruttura:

- Una testa per travetto in alluminio, il cui aggancio, garantito dalla specifica conformazione delle alette, permette di accogliere il travetto senza necessità di fissaggi ulteriori (PR, SE e NM).
- Una testa universale per travetti in legno o altri materiali (PR, SE e NM).
- Una testa reversibile per travetti in alluminio, legno o altri materiali, esclusiva per il supporto Reversus® (SRT).
- Una testa a incrocio per travetto in alluminio (PR, SE e NM).

I supporti della serie Star.T e Basic posso essere utilizzati per travetti in alluminio e legno.

Fra i supporti della gamma EH, solo il supporto EH12 può essere usato per travetti in alluminio.

A complete and versatile system for the laying of slabs and planks with various types of head to answer every constructive need.

The Woodeck system provides various types of head for the support of the substructure:

- A head for aluminium joist that allows to fit the joist without the need for additional fastening, thanks to the special shape of the hooking tabs (PR, SE and NM).
- A universal head for wooden joists or other materials (PR, SE and NM).
- A reversible head for aluminium and wood joist or other materials, exclusive for the Reversus® (SRT) support.
- A Criss-cross head for aluminium joist (PR, SE and NM).

The Star.T and Basic supports can be used for aluminum and wood joist.

Among the supports in the EH range, only the EH12 support can be used for aluminum joists.

CODICE CODE	DESCRIZIONE DESCRIPTION	APPLICAZIONE APPLICATION	MISURA SIZE	PAG. LISTINO PRICE LIST PAGE	PZ 
E035100010	Testa bicomponente autolivellante per travetto in alluminio <i>Two-component self-leveling head for aluminium joist</i>	PR - SE	Ø 110 mm	7	200
E034000010	Testa bicomponente per travetto in alluminio <i>Two-component head for aluminium joist</i>	NM	Ø 110 mm	19	200
E035102530	Testa autolivellante per travetto in legno <i>Self-leveling head for decking</i>	PR - SE	Ø 110 mm	7	100
E034000030	Testa per travetto in legno <i>Head for decking</i>	NM	Ø 110 mm	19	150
E030001010	Testa reversibile bicomponente alette 4 mm / Travetto in alluminio e legno	SRT	Ø 110 mm	10	200
E030001030	<i>Two-component reversible head with 4 mm tabs / aluminium and wooden joist</i>		Ø 150 mm	10	100

Testa per travetto in alluminio Head for aluminium joist



Il sistema di sottostruttura con travetto in alluminio si assembla senza l'ausilio di viti ed è composto dai seguenti elementi: testa con due alette preformate per accogliere il travetto in alluminio; travetto in alluminio; clip in acciaio, per il fissaggio del listone, distanziatore in PP per posa di listoni/lastre in gres.



The substructure system with aluminium joist is assembled without the aid of screws and is composed of the following elements: head with two pre-formed flaps for the aluminium joist, aluminium joist, steel clips, PP spacer for laying stoneware planks/slabs.

Testa per travetto in legno Universal head for decking



La testa universale è studiata per accogliere e consentire il fissaggio di tutti i tipi di travetto esistenti in commercio.



The universal head is designed to accommodate and permit the fastening of all types of existing joists on the market.

Testa reversibile per travetto in alluminio e legno (Reversus®) Reversible head for aluminium/wood joist (Reversus®)

**NOVITÀ
NEWS**

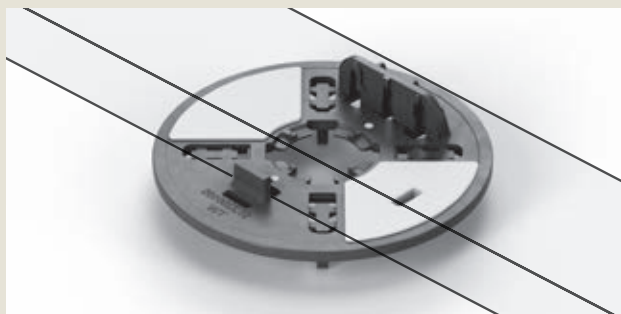

L'innovativa testa bi-componente (PP + gomma) da un lato ha le alette per la posa delle lastre e dall'altro è predisposta per la posa dei travetti in alluminio e legno.

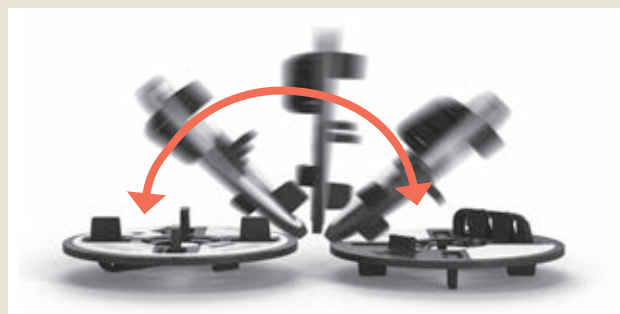

The innovative head in two-component (PP + rubber) on one side it has the tabs for laying the slabs and on the other side it is designed for the laying of aluminium and wooden joists.

Testa a incrocio per travetti in alluminio Criss-cross head for aluminium joists

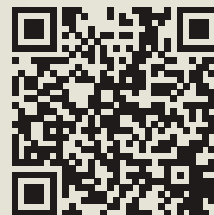

Guarda il video di presentazione



Watch the presentation video

Questa nuova tipologia di testa consente di appoggiare uno, due, tre o quattro travetti in alluminio contemporaneamente sulla testa del supporto. Può essere utilizzata in sostituzione della classica testa per travetto in alluminio per l'appoggio di uno, due travetti, o nel caso si vogliano appoggiare più travetti sulla stessa testa. È di fatto un "giunto a incrocio".

La testa è dotata di 8 alette verticali preformate che aggranciano i fianchi del travetto.

La testa è prodotta in due tipologie: basculante per supporti PR, SE e non basculante per supporti NM.

This new type of head allows to lay on the support one, two, three or four aluminium joists at the same time. It can be used as a replacement of the standard head for one or two joists or to support multiple joists on the same head; it is in fact a "cross joint".

The head is provided with 8 vertical preformed tabs that hook the sides of the joists.

The head is produced in two types: tilting for PR, SE supports and non-tilting for NM supports.

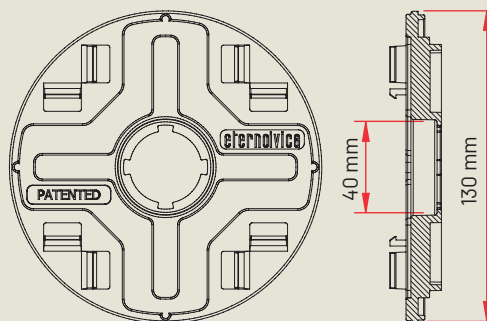
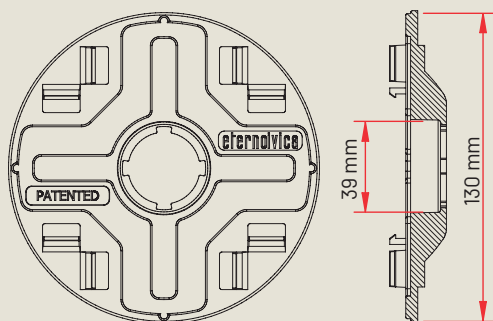

Versione basculante per supporti PR e SE
Tilting version for PR and SE supports

Versione fissa per supporti NM
Fixed version for NM supports



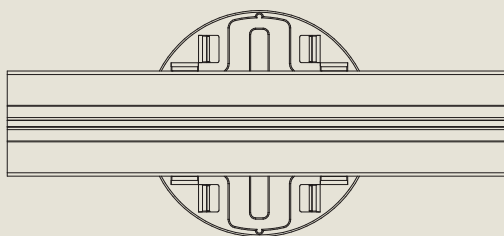
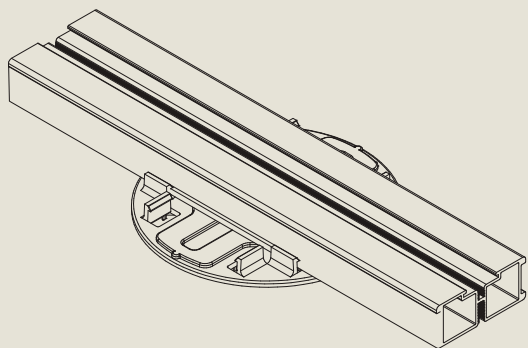

1 travetto passante
1 through joist

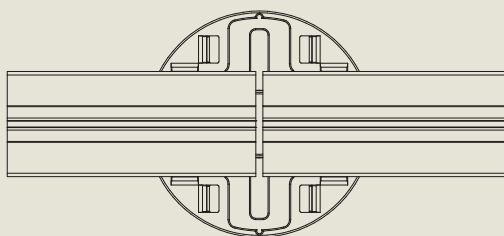
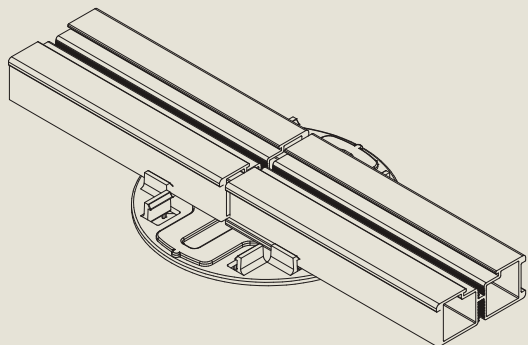

2 travetti di testa
2 front joists

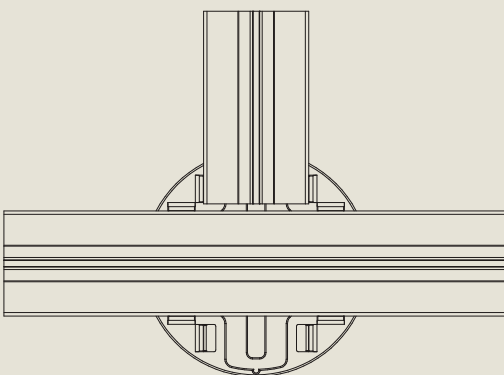
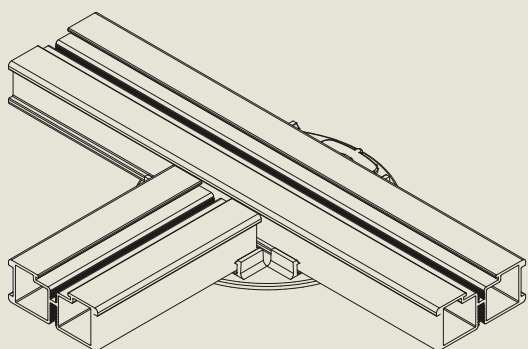

1 travetto passante + 1 travetto di testa
1 through joist + 1 front joist

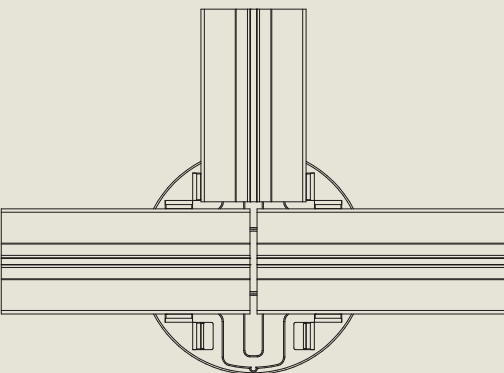
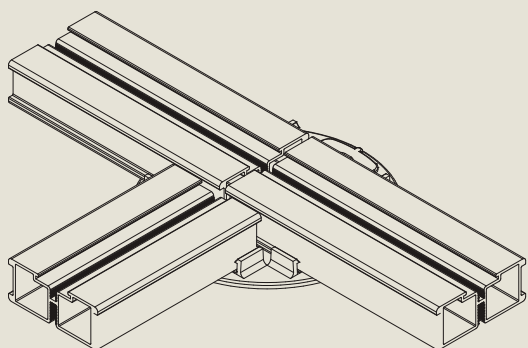

3 travetti di testa
3 front joists

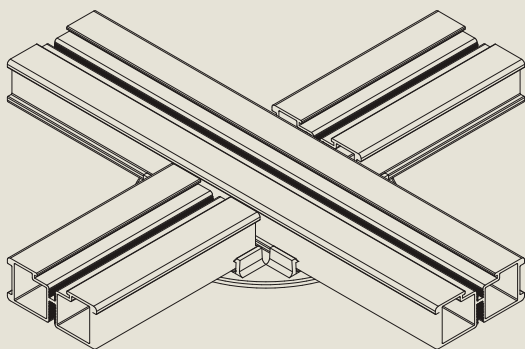

1 travetto passante + 2 travetti di testa
1 through joist + 2 front joists

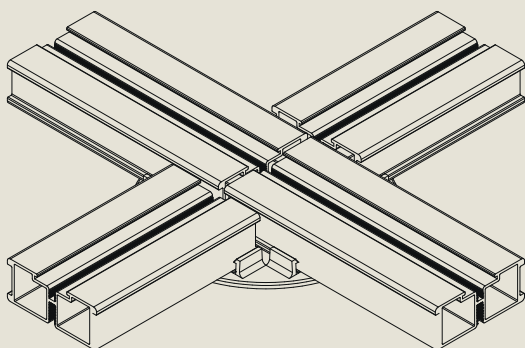
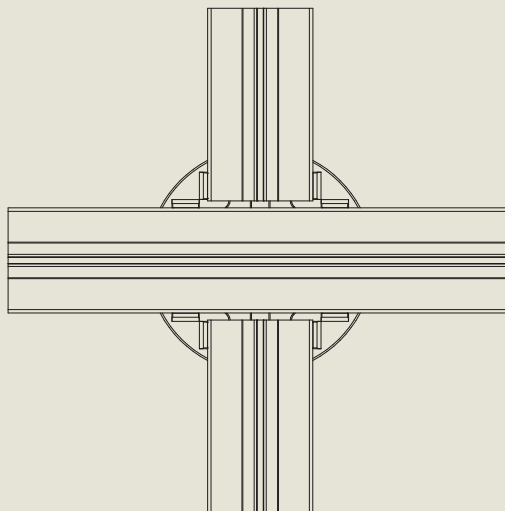

4 travetti di testa
4 front joists

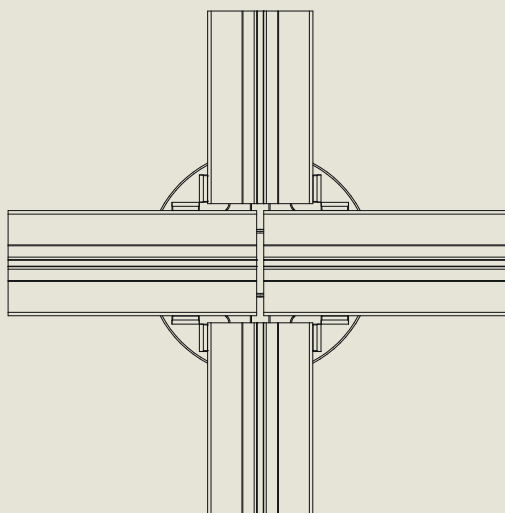

CODICE CODE	DESCRIZIONE DESCRIPTION	APPLICAZIONE APPLICATION	MISURA SIZE	PAG. LISTINO PRICE LIST PAGE	PZ 
E035203001	Testa autolivellante bicomponente PP+ gomma per travetto in alluminio <i>Self-leveling PP + rubber two-component head for aluminium joist</i>	PR - SE	Ø 130 mm	7	150
E035093001	Testa bicomponente PP + gomma per travetto in alluminio <i>PP + rubber two-component head for aluminium joist</i>	NM	Ø 130 mm	19	150

Gli elementi del sistema Woodeck

The elements of Woodeck System

Un sistema completo e versatile per l'installazione di lastre e listoni per tutte le esigenze costruttive.

A complete and versatile system for the installation of slabs and planks to meet all construction needs.



Posa Woodeck con ceramica, legno e/o WPC

Laying Woodeck with ceramic slab, wood and/or WPC



Step 01: la sottostruttura

Agganciare i travetti ai supporti. I travetti in alluminio si fissano “a scatto” grazie alla speciale testa, i travetti in legno si fissano con le viti grazie alla speciale aletta laterale. Posizionare i supporti con l’interasse corretto.

Step 01: the substructure

Hook the joists on the supports. The aluminum joists are fixed “by snapping” thanks to the special head, while the wooden joists are fixed with screws using the special side flap. Place the supports with the correct interaxle.



Step 02: la regolazione

Posizionare i travetti con i supporti agganciati e regolare l’altezza dei due supporti alle estremità: il primo e l’ultimo di ogni travetto.

Svitare i rimanenti supporti centrali sino a posarsi sul sottofondo per dare stabilità all’intero travetto.

Step 02: adjustment

Place on the floor the joists with the supports hooked and adjust the height of the two end supports: the first and the last of each joist.

Unscrew the remaining central supports until they rest on the subfloor to provide stability to the entire joist.



Step 03: la posa

Posare gli elementi di pavimentazione (listoni di ceramica, listoni in WPC o legno...) sopra i travetti e fissarli grazie ai numerosi accessori Eterno Ivica.

Step 03: laying

Lay the flooring elements (ceramic slabs and/or planks, WPC or wooden planks) on top of the joists and secure them using various Eterno Ivica accessories.

Guida all'utilizzo dei travetti in alluminio

Guide to using aluminum joists



Guarda il video
di presentazione



Watch the
presentation video



SUPPORTO SUPPORT	Posa lastre in ceramica monoformato Posa lastre in ceramica multiformato Posa listoni in ceramica <i>Laying of multi-format ceramic slabs Laying single size ceramic slabs Laying ceramic planks</i>		Posa listoni in legno/WPC <i>Laying WPC/wooden planks</i>	
	Travetto alluminio <i>Aluminium joist</i>	Travetto legno <i>Wooden joist</i>	Travetto alluminio <i>Aluminium joist</i>	Travetto legno <i>Wooden joist</i>
PEDESTAL PRIME®	✓	✗	✓	✓
REVERSUS®	✓	✗	✓	✓
SE	✓	✗	✓	✓
NM	✓	✗	✓	✓
SB	✓	✗	✓	✓
Star.T	✓	✗	✓	✓

CODICE CODE	DESCRIZIONE DESCRIPTION	LASTRE SLABS			DECKING		
		Lastre in ceramica/cemento/... Lastre in ceramica multiformato <i>Ceramic/cement slabs/ Multi-size ceramic slabs</i>			Listoni in legno Listoni in WPC Listoni in ceramica <i>Wood planks WPC planks Ceramic planks</i>		
Q231020025	Travetto standard <i>Standard joist</i>	✔			✔		
Q231420026	Travetto a deflusso rapido <i>Joist for rapid flow</i>	✔ Consigliato <i>Recommended</i>			✔		
Q231020020 Q231020020.N	Travetto eco standard <i>Standard ECO joist</i>	✔			✔		
Q231020021 Q231020021.N	Travetto ECO a deflusso rapido <i>ECO joist for rapid flow</i>	✔ Consigliato <i>Recommended</i>			✔		

CODICE CODE	DESCRIZIONE DESCRIPTION	CALPESTIO ALTO HIGH FOOT TRAFFIC			CALPESTIO MEDIO/BASSO MEDIUM/LOW FOOT TRAFFIC		
		Edifici del settore ricettivo e alberghiero Bordi piscine pubbliche Centri direzionali e commerciali Tetti piani e terrazze pubbliche Zone esterne di bar e ristoranti Camminamenti pubblici <i>Buildings in the hospitality and hotel sector Poolsides of public swimming pools Business and commercial centers Flat roofs and public terraces Outdoor areas of bars and restaurants Public walkways</i>			Abitazioni civili Bordi piscine private Tetti piani e terrazze private Camminamenti privati <i>Residential homes Poolsides of private swimming pools Flat roofs and private terraces Private walkways</i>		
		Interasse supporti <i>Interaxle spacing supports</i>			Interasse supporti <i>Interaxle spacing supports</i>		
		40 cm	50 cm	66,6 cm	40 cm	50 cm	66,6 cm
Q231020025	Travetto standard <i>Standard joist</i>	✔	✔	✔	✔	✔	✔
Q231420026	Travetto a deflusso rapido <i>Joist for rapid flow</i>	✔	✔	✔	✔	✔	✔
Q231020020 Q231020020.N	Travetto eco standard <i>Standard ECO joist</i>	✔	✔	✘	✔	✔	✘
Q231020021 Q231020021.N	Travetto ECO a deflusso rapido <i>ECO joist for rapid flow</i>	✔	✔	✘	✔	✔	✘

Come calcolare il consumo di travetti, supporti e clip per la posa di lastre in ceramica mono e multiformato



1. La prima operazione è quella di definire l'interasse dei travetti e dei supporti
 1. *The first operation is to define the interaxle spacing between the joists and supports*

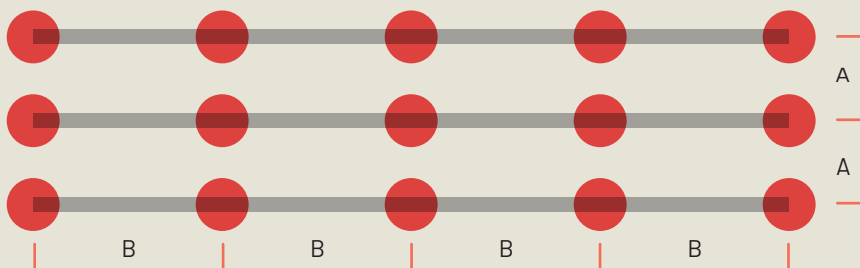

- A** Interasse travetti
Interaxle joists
- B** Interasse supporti:
40 - 50 - 66,6 cm
Interaxle supports:
40 - 50 - 66,6 cm

2. Una volta definito l'interasse dei travetti si possono calcolare i mt di travetto a mq e il numero di distanziatori (clip) a croce a mq
 2. *Once the interaxle distance of the joists has been defined, the mt of joists and the number of slab spacers (clips) per square meter can be calculated*

L'interasse dei travetti si calcola in base alle misure delle lastre di ceramica.
The joists interaxle spacing is calculated on the basis of the measurements of the ceramic slabs.

TRAVETTI ALLUMINIO L 200 CM ALUMINIUM JOIST L.200 CM	INTERASSE TRAVETTI INTERAXLE JOIST A	MISURA LASTRA SLABS DIMENSION	MT TRAVETTO A MQ MT JOIST PER SQUARE METER	N° CLIP A MQ N° SLAB SPACERS (CLIP) PER SQUARE METER (E004000104)
	30 cm	30 x 60 cm 30 x 90 cm	3,33	5,7 3,75
	37,5 cm	75 x 75 cm	2,68	1,8
	40 cm	40 x 60 cm 40 x 80 cm 40 x 120 cm 80 x 80 cm	2,50	4,25 3,2 2,1 1,6
	45 cm	30 x 90 cm 40 x 90 cm 45 x 90 cm 60 x 90 cm 90 x 90 cm	2,25	3,75 2,8 2,5 1,9 1,3
	50 cm	50 x 50 cm	2,00	4
	60 cm	60 x 30 cm 60 x 40 cm 60 x 60 cm 40 x 120 cm 60 x 120 cm 120 x 120 cm	1,67	5,7 4,25 2,78 2,1 1,45 0,8

How to calculate the use of joists, supports and clips for laying single and multi-format ceramic slabs



- Una volta definito l'interasse dei supporti si può calcolare il numero di supporti a mq
- Once the interaxle spacing of the supports has been defined, the number of supports per square meter can be calculated

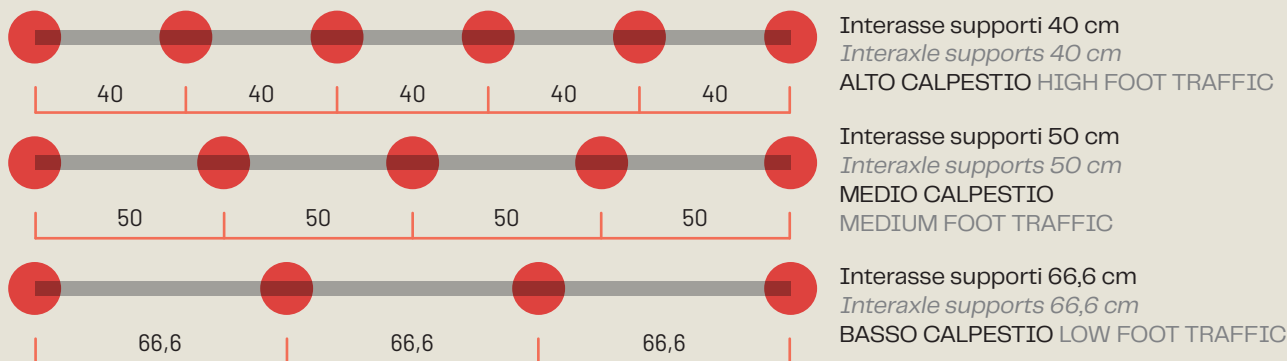

L'interasse dei supporti viene definito in base al tipo di calpestio del pavimento: ALTO, MEDIO, BASSO.

Il numero di supporti a mq varia a seconda dell'interasse del travetto e dell'interasse dei supporti.

The interaxle distance between the supports is defined according to the type of foot traffic on the floor: HIGH, MEDIUM, LOW. The number of supports per square meter varies according to the distance between the beams and the distance between the supports.

INTERASSE SUPPORTI INTERAXLE SUPPORTS B	INTERASSE TRAVETTI INTERAXLE JOIST A	N° SUPPORTI A MQ N° SUPPORTS PER SQUARE METER
40 cm ALTO CALPESTIO <i>HIGH FOOT TRAFFIC</i>	30 cm	8,4
	37,5 cm	6,7
	40 cm	6,25
	45 cm	5,6
	50 cm	5
	60 cm	4,17
50 cm MEDIO CALPESTIO <i>MEDIUM FOOT TRAFFIC</i>	30 cm	6,7
	37,5 cm	5,4
	40 cm	5
	45 cm	4,5
	50 cm	4
	60 cm	3,4
66,6 cm BASSO CALPESTIO <i>LOW FOOT TRAFFIC</i>	30 cm	5
	37,5 cm	4
	40 cm	3,75
	45 cm	3,4
	50 cm	3
	60 cm	2,6

Schemi di montaggio per la posa di lastre in ceramica mono e multiformato

ESEMPIO CON INTERASSE SUPPORTI 50 CM



Lastra | Slab 30 x 60 cm - Interasse travetto | Interaxle joist 30 cm

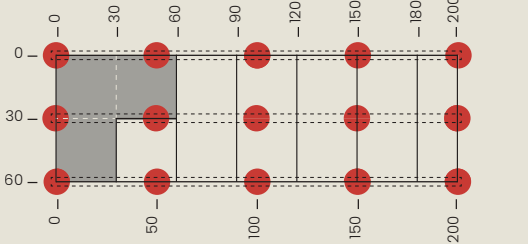

Lastra | Slab 30 x 60 cm - Interasse travetto | Interaxle joist 60 cm

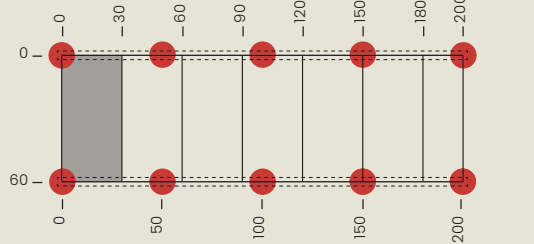

Lastra | Slab 30 x 90 cm - Interasse travetto | Interaxle joist 30 cm

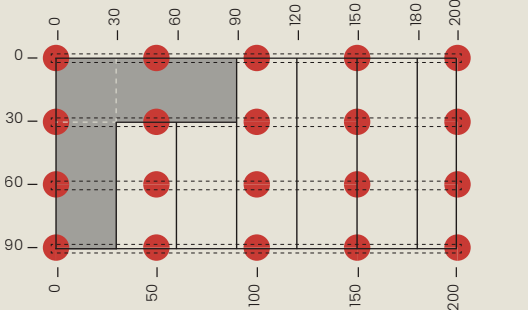

Lastra | Slab 60 x 90 cm - Interasse travetto | Interaxle joist 45 cm

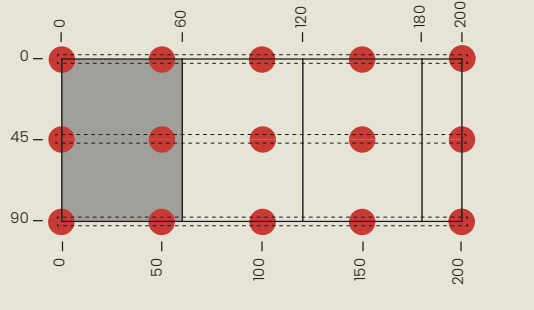

Lastra | Slab 30 x 90 cm - Interasse travetto | Interaxle joist 45 cm

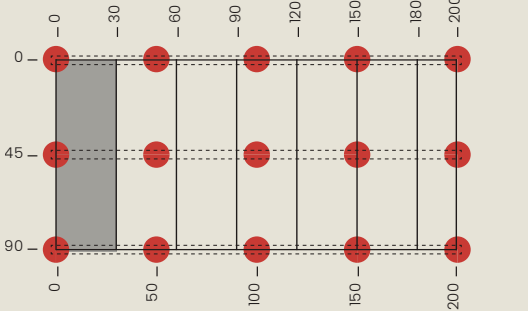

Lastra | Slab 60 x 120 cm - Interasse travetto | Interaxle joist 60 cm

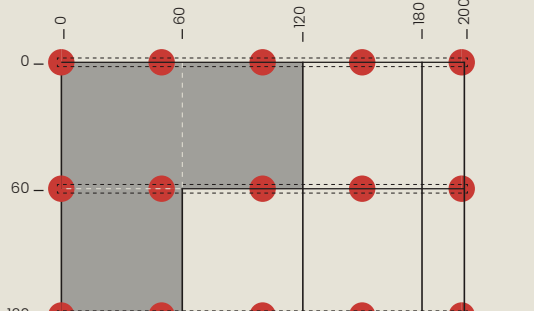

Lastra | Slab 45 x 90 cm - Interasse travetto | Interaxle joist 45 cm

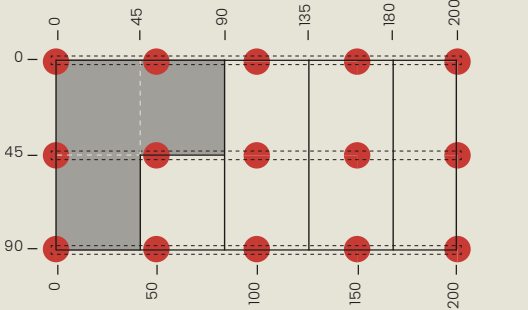

Lastra | Slab 40 x 60 cm - Interasse travetto | Interaxle joist 60 cm

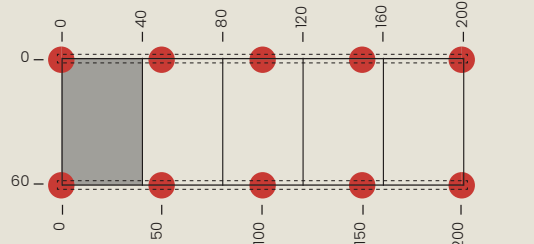

Lastra | Slab 40 x 60 cm - Interasse travetto | Interaxle joist 40 cm

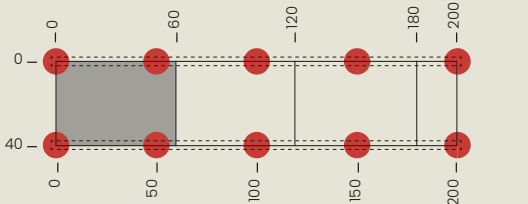

Lastra | Slab 40 x 80 cm - Interasse travetto | Interaxle joist 40 cm

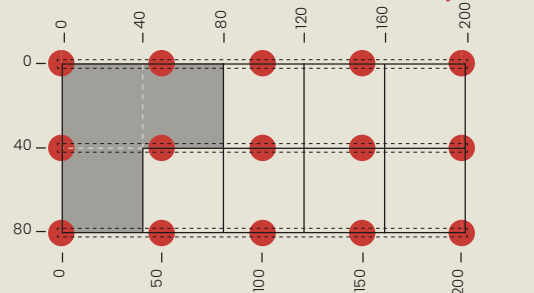

Single and multi-format ceramic slab assembly diagrams

EXAMPLE WITH 50 CM SUPPORT INTERAXLE



Lastra | Slab 45 x 90 cm - Interasse travetto | Interaxle joist 45 cm

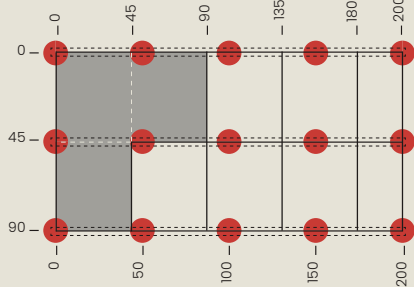

Lastra | Slab 50 x 50 cm - Interasse travetto | Interaxle joist 50 cm

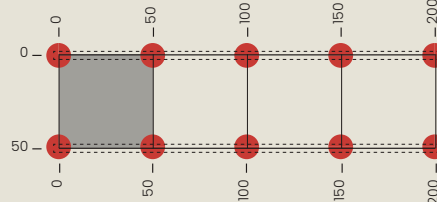

Lastra | Slab 40 x 80 cm - Interasse travetto | Interaxle joist 40 cm

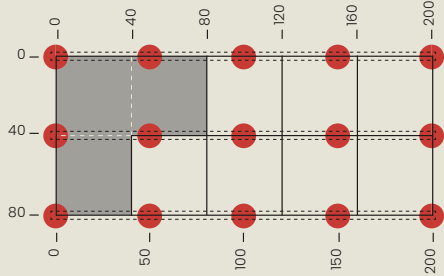

Lastra | Slab 60 x 60 cm - Interasse travetto | Interaxle joist 60 cm

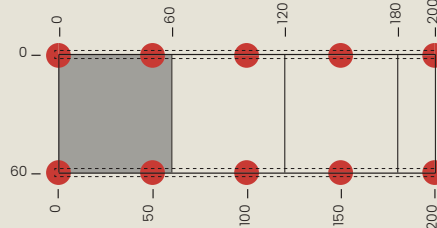

Lastra | Slab 40 x 120 cm - Interasse travetto | Interaxle joist 60 cm

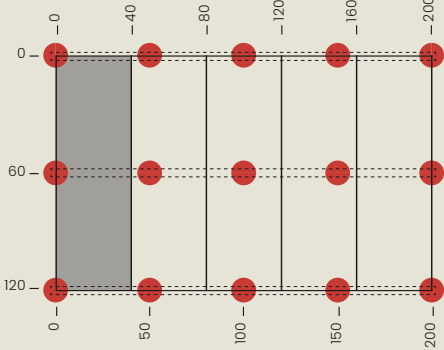

Lastra | Slab 75 x 75 cm - Interasse travetto | Interaxle joist 37,5 cm

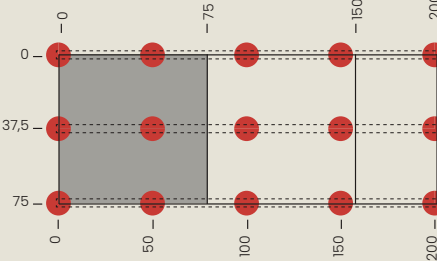

Lastra | Slab 80 x 80 cm - Interasse travetto | Interaxle joist 40 cm

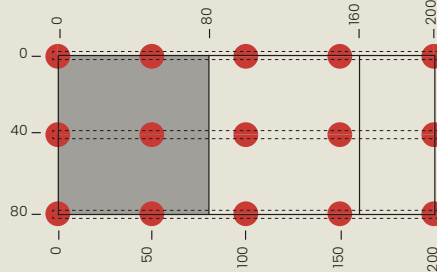

Lastra | Slab 120 x 120 cm - Interasse travetto | Interaxle joist 60 cm

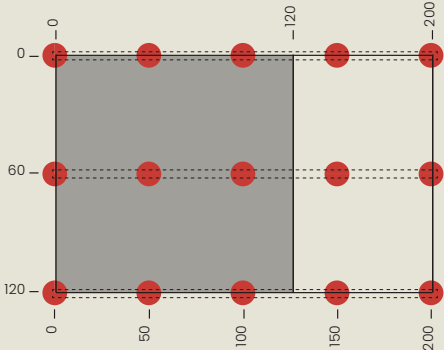

Lastra | Slab 90 x 90 cm - Interasse travetto | Interaxle joist 45 cm

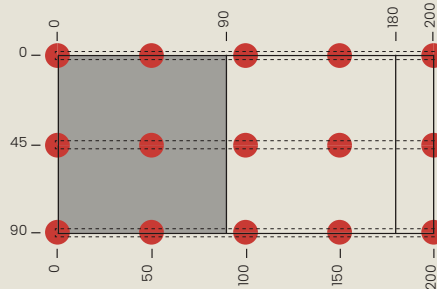

Come calcolare il consumo di travetti, supporti e clip per la posa di listoni in ceramica

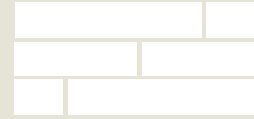

1. La prima operazione è quella di definire l'interasse dei travetti e dei supporti
1. *The first operation is to define the interaxle spacing between the joists and supports*

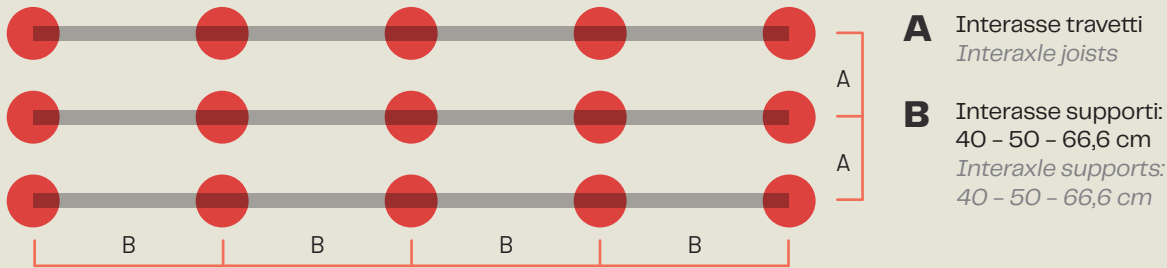

2. Una volta definito l'interasse dei travetti si possono calcolare i mt di travetto a mq e il numero di distanziatori (clip) a croce a mq
2. *Once the interaxle distance of the joists has been defined, the mt of joists and the number of slab spacers (clips) per square meter can be calculated*

L'interasse dei travetti si calcola in base alle misure delle lastre in ceramica e al tipo di calpestio del pavimento: ALTO, MEDIO, BASSO.

The joists interaxle spacing is calculated on the basis of the measurements of the ceramic slabs and type of foot traffic on the floor: HIGH, MEDIUM, LOW.

TRAVETTI ALLUMINIO L 200 CM ALUMINIUM JOIST L.200 CM	INTERASSE TRAVETTI INTERAXLE JOIST A	MISURA LISTONE PLANK DIMENSION	MT TRAVETTO A MQ MT JOIST PER SQUARE METER	N° CLIP A MQ N° SLAB SPACERS (CLIP) PER SQUARE METER (E004000104)
	40 cm ALTO CALPESTIO <i>HIGH FOOT TRAFFIC</i>	20 x 120 cm 30 x 120 cm 40 x 120 cm	2,5	4,16 2,8 2,1
	45 cm MEDIO CALPESTIO <i>MEDIUM FOOT TRAFFIC</i>	30 x 180 cm 40 x 180 cm	2,25	1,85 1,4
	60 cm BASSO CALPESTIO <i>LOW FOOT TRAFFIC</i>	20 x 120 cm 30 x 120 cm 40 x 120 cm 30 x 180 cm 40 x 180 cm	1,67	4,16 2,8 2,1 1,85 1,4

How to calculate the use of joists, supports and clips for laying ceramic planks



- Una volta definito l'interasse dei supporti si può calcolare il numero di supporti a mq
- Once the interaxle spacing of the supports has been defined, the number of supports per square meter can be calculated

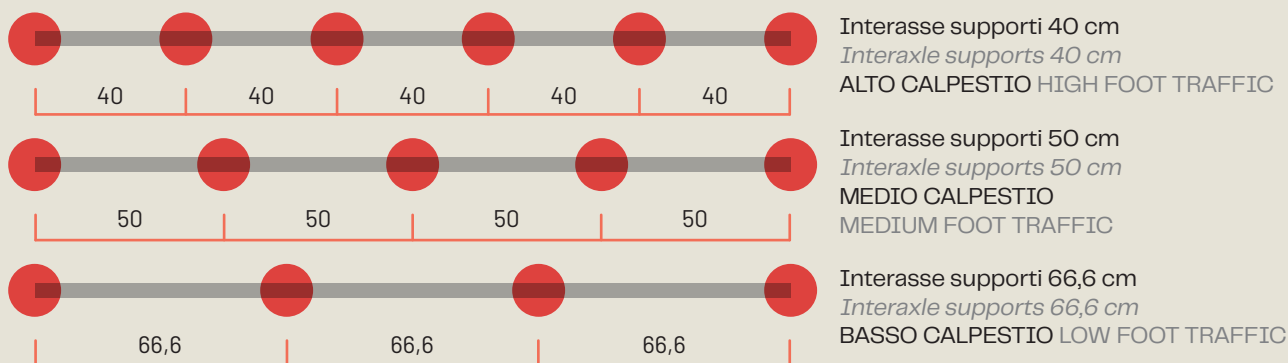

L'interasse dei supporti viene definito in base al tipo di calpestio del pavimento: ALTO, MEDIO, BASSO. Il numero di supporti a mq varia a seconda dell'interasse del travetto e dell'interasse dei supporti.

The interaxle distance between the supports is defined according to the type of foot traffic on the floor: HIGH, MEDIUM, LOW. The number of supports per square meter varies according to the distance between the joists and the distance between the supports.

INTERASSE SUPPORTI INTERAXLE SUPPORTS B	INTERASSE TRAVETTI INTERAXLE JOIST A	N° SUPPORTI A MQ N° SUPPORTS PER SQUARE METER
40 cm ALTO CALPESTIO HIGH FOOT TRAFFIC	40 cm	6,25
	45 cm	5,6
	60 cm	4,25
50 cm MEDIO CALPESTIO MEDIUM FOOT TRAFFIC	40 cm	5
	45 cm	4,5
	60 cm	3,4
66,6 cm BASSO CALPESTIO LOW FOOT TRAFFIC	40 cm	3,75
	45 cm	3,4
	60 cm	2,6



Clip rapida con alette 4 mm H 12 mm
Slab spacers with 4 thick H 12 mm tabs



Schemi di montaggio per la posa di listoni in ceramica

ESEMPIO CON INTERASSE SUPPORTI 50 CM



Listone | Plank 20 x 120 cm - Interasse travetto | Interaxle joist 40 cm

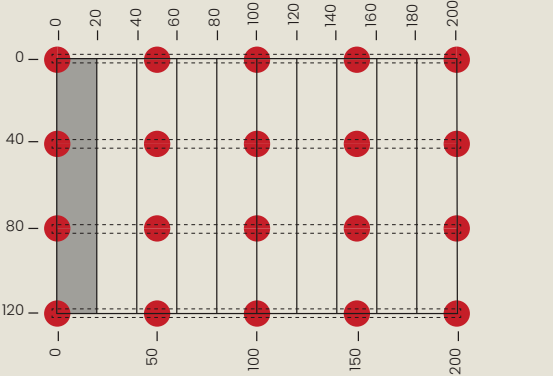

Listone | Plank 20 x 120 cm - Interasse travetto | Interaxle joist 60 cm

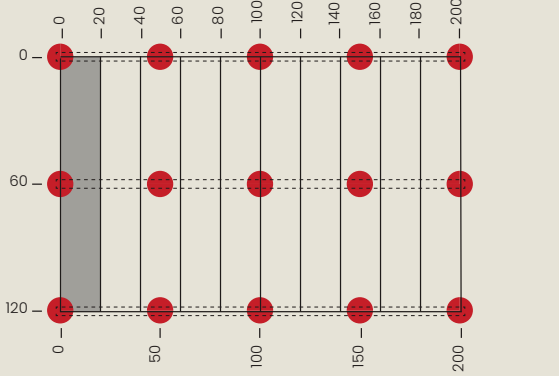

Listone | Plank 30 x 120 cm - Interasse travetto | Interaxle joist 40 cm

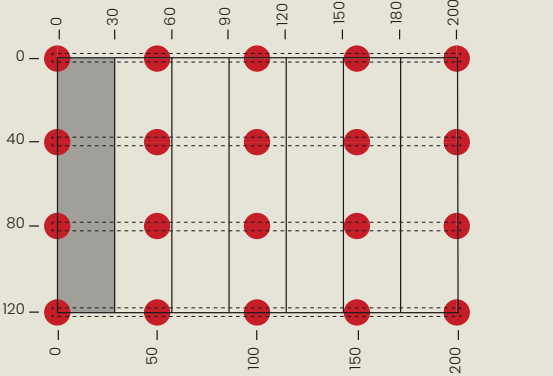

Listone | Plank 30 x 120 cm - Interasse travetto | Interaxle joist 60 cm

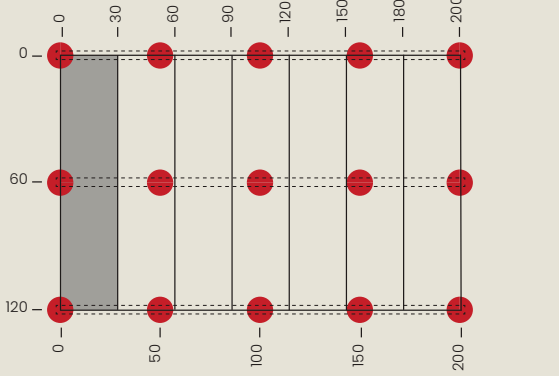

Listone | Plank 40 x 120 cm - Interasse travetto | Interaxle joist 40 cm

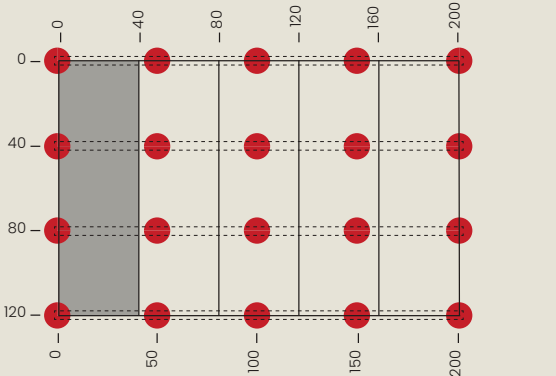

Listone | Plank 40 x 120 cm - Interasse travetto | Interaxle joist 60 cm

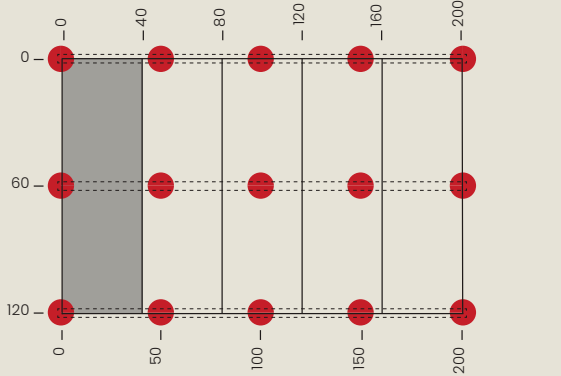

Assembly diagrams of ceramic planks

EXAMPLE WITH 50 CM SUPPORT INTERAXLE



Listone | Plank 30 x 180 cm - Interasse travetto | Interaxle joist 45 cm

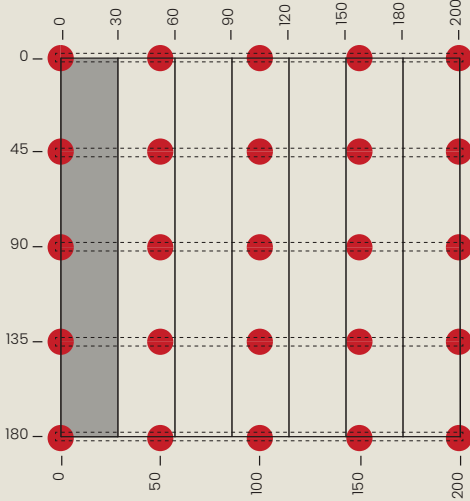

Listone | Plank 30 x 180 cm - Interasse travetto | Interaxle joist 60 cm

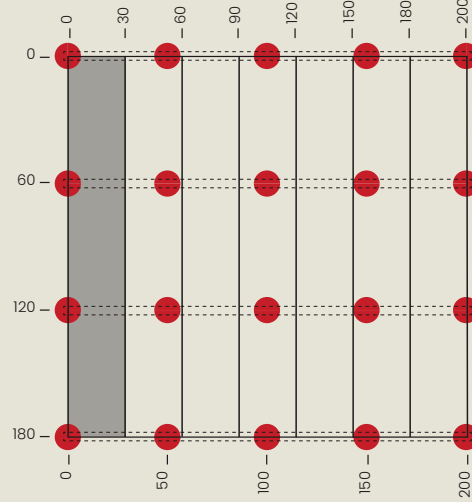

Listone | Plank 40 x 180 cm - Interasse travetto | Interaxle joist 45 cm

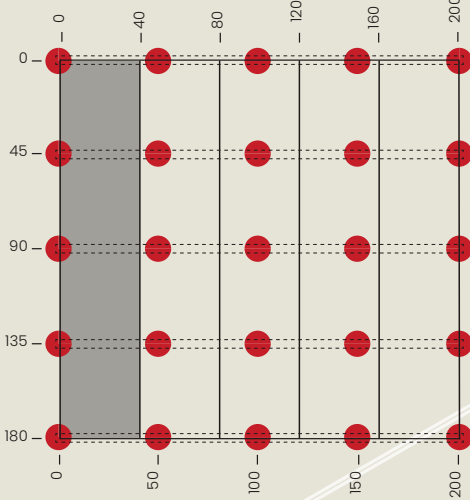

Listone | Plank 40 x 180 cm - Interasse travetto | Interaxle joist 60 cm

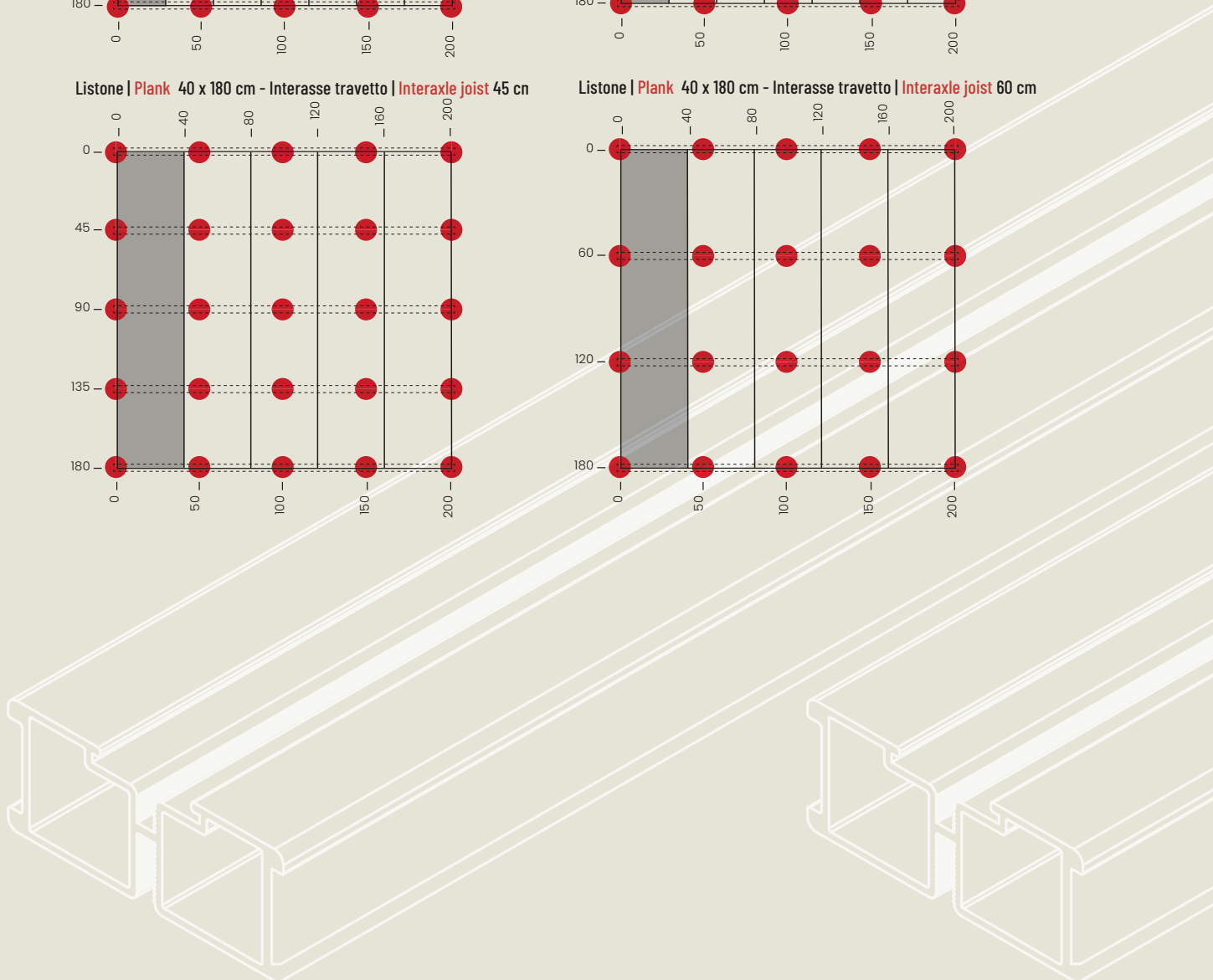
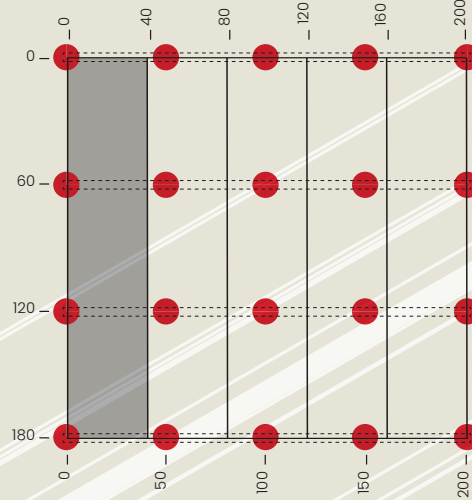

Come calcolare il consumo di travetti, supporti e clip per la posa di listoni in legno/WPC

1. La prima operazione è quella di definire l'interasse dei travetti e dei supporti
 1. *The first operation is to define the interaxle spacing between the joists and supports*

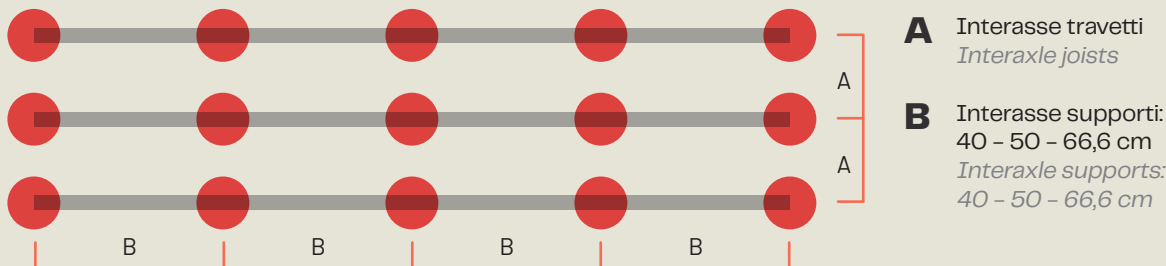

2. Una volta definito l'interasse dei travetti si possono calcolare i mt di travetto a mq e il numero di clip a mq
 2. *Once the interaxle distance of the joists has been defined, The mt of joists and the number of slab spacers (clips) per square meter can be calculated*

l'interasse dei travetti si calcola in base al tipo di calpestio del pavimento: ALTO, MEDIO, BASSO.
The interaxle distance between the supports is defined according to the type of foot traffic on the floor: HIGH, MEDIUM, LOW.

TRAVETTI ALLUMINIO L 200 CM ALUMINIUM JOIST L.200 CM	INTERASSE TRAVETTI * INTERAXLE JOIST* A	MISURA LISTONE PLANK DIMENSION	MT TRAVETTO A MQ MT JOISTS PER SQUARE METER	N° CLIP SINGOLA MT TRAVETTO SINGLE CLIP MT PER JOIST	N° CLIP DOPIA MT TRAVETTO DOUBLE CLIP MT PER JOIST
	30 cm ALTO CALPESTIO e/o basso spessore listone <i>HIGH FOOT TRAFFIC</i>	Lunghezza <i>Length</i> : da 95 a 225 cm Larghezza <i>Width</i> : da 9 a 14,5 cm Spessore <i>Thickness</i> : da 1,9 a 3 cm	3,3	A	B
	40 cm MEDIO CALPESTIO e/o medio spessore listone <i>MEDIUM FOOT TRAFFIC</i>	Lunghezza <i>Length</i> : da 95 a 225 cm Larghezza <i>Width</i> : da 9 a 14,5 cm Spessore <i>Thickness</i> : da 1,9 a 3 cm	2,50	A	B
	50 cm BASSO CALPESTIO e/o alto spessore listone <i>LOW FOOT TRAFFIC</i>	Lunghezza <i>Length</i> : da 95 a 225 cm Larghezza <i>Width</i> : da 9 a 14,5 cm Spessore <i>Thickness</i> : da 1,9 a 3 cm	2,00	A	B

* Consigliamo di verificare sempre l'interasse del travetto con il produttore dei listoni di legno.
 * *We recommend that you always check the distance between the joist and the producer of the wooden planks.*

- A** 1 mt (1000 mm) : larghezza listone x 2.
 es: 1000 mm : 140 mm = 7,14 x 2 = 14,28 clip/mt travetto.
- A** 1 mt (1000 mm) : plank width x 2
 Ex : 1 000 mm : 140 mm = 7,14 x 2 = 14,28 clip/mt joist
- B** 1 mt (1000 mm) : larghezza listone.
 es: 1000 mm : 140 mm = 7,14 clip/mt travetto.
- B** 1 mt (1000 mm) : plank width
 Ex : 1 000 mm : 140 mm = 7,14 clip/mt joist

How to calculate the use of joists, supports and clips for laying wooden/WPC planks

- Una volta definito l'interasse dei supporti si può calcolare il numero di supporti a mq
- Once the interaxel spacing of the supports has been defined, the number of supports per square meter can be calculated

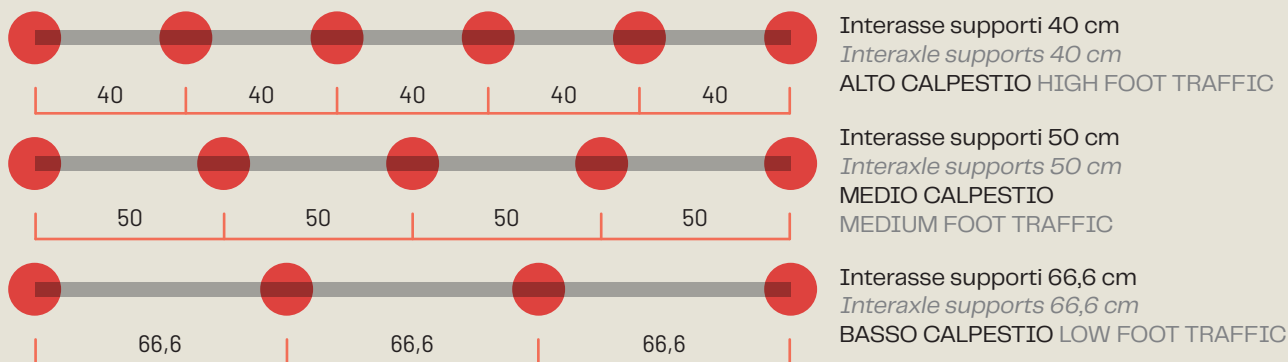









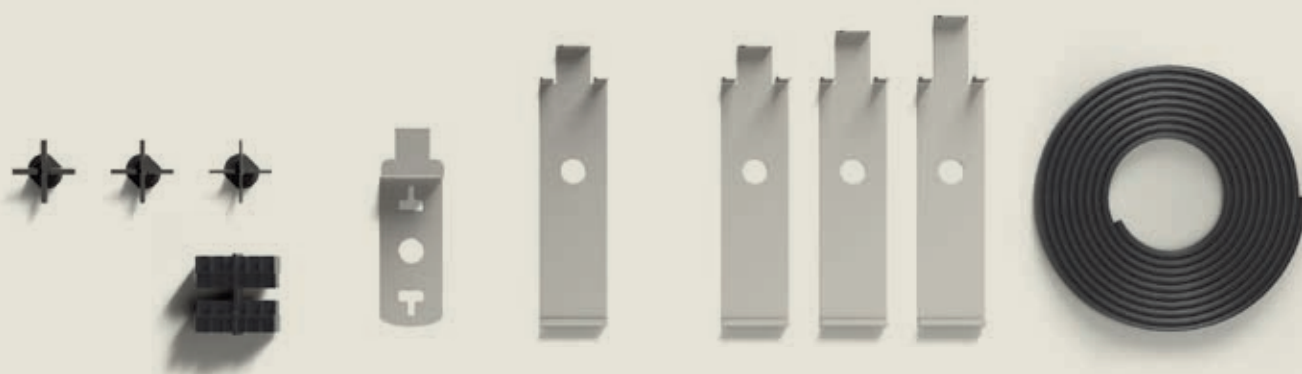







L'interasse dei supporti viene definito in base al tipo di calpestio del pavimento: ALTO, MEDIO, BASSO. Il numero di supporti a mq varia a seconda dell'interasse del travetto e dell'interasse dei supporti. *The interaxle distance between the supports is defined according to the type of foot traffic on the floor: HIGH, MEDIUM, LOW. The number of supports per square meter varies according to the distance between the joists and the distance between the supports.*

INTERASSE SUPPORTI INTERAXLE SUPPORTS B	INTERASSE TRAVETTI INTERAXLE JOIST A	N° SUPPORTI A MQ N° SUPPORTS PER SQUARE METER
40 cm ALTO CALPESTIO <i>HIGH FOOT TRAFFIC</i>	30 cm	8,4
	40 cm	6,25
	50 cm	5
50 cm MEDIO CALPESTIO <i>MEDIUM FOOT TRAFFIC</i>	30 cm	6,7
	40 cm	5
	50 cm	4
66,6 cm BASSO CALPESTIO <i>LOW FOOT TRAFFIC</i>	30 cm	5
	40 cm	3,75
	50 cm	3

Compatibilità accessori

Accessories compatibility



TRAVETTO JOIST	GOMMA ANTI RUMORE NOISE INSULATING RUBBER (V13052100)	GUARNIZIONE IN PVC PVC GASKET (V13052200) (V13052205)	GIUNTO STANDARD STANDARD JOINT (Q200000025)	GIUNTO A DEFLUSSO RAPIDO JOINT FOR RAPID FLOW JOIST (Q200000026)
Travetto standard <i>Standard joist</i>				
Travetto a deflusso rapido <i>Joist for rapid flow</i>				
Travetto eco standard <i>Standard ECO joist</i>				
Travetto ECO a deflusso rapido <i>ECO joist for rapid flow</i>				

La gamma completa di accessori per pavimentazioni sopraelevate su travetto realizzate a regola d'arte. Eterno Ivica offre un'ampia gamma di accessori complementari alla sottostruttura con travetto in alluminio o legno.

The complete range of accessories for elevated flooring systems built on joists, executed with the utmost craftsmanship, is available. Eterno Ivica offers a wide range of complementary accessories for both aluminum and wooden joist substructures.

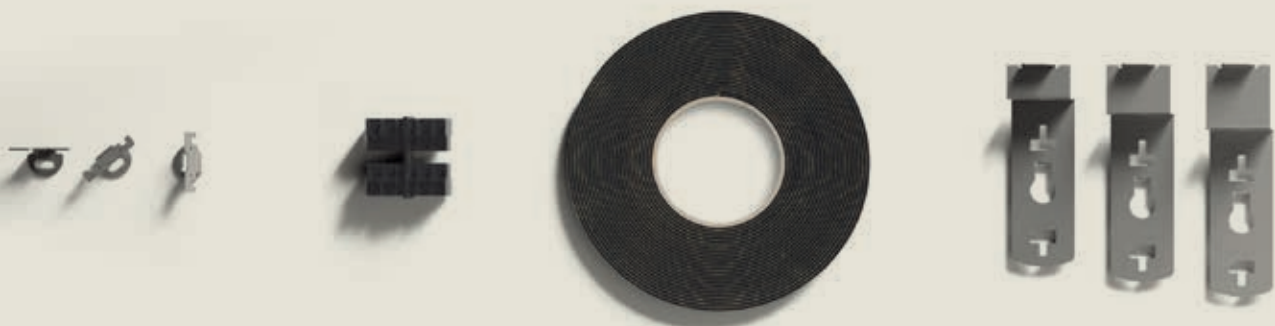

	DISTANZIATORE (CLIP) A CROCE SLAB SPACER (CLIP) (E004000104)	CLIP DI TESTA HEAD CLIP (Q200000240)	CLIP SINGOLA PER DECKING SINGLE CLIP FOR DECKING 110° (Q200000231) 90° (Q200000232)	CLIP DOPPIA PER DECKING DOUBLE DECKING CLIP 110° (Q200000265) 90° (Q200000260) 90° (Q200000261)	CLIP DOPPIA CON DOPPIA VITE DI FISSAGGIO DOUBLE CLIP WITH FIXING SCREWS (Q200000008)
	✓	✓	✓	✓	✓
	✓	✓	✓	✓	✗
	✓	✓	✓	✓	✓
	✓	✓	✓	✓	✗

Travetto in alluminio standard

Standard aluminium joist

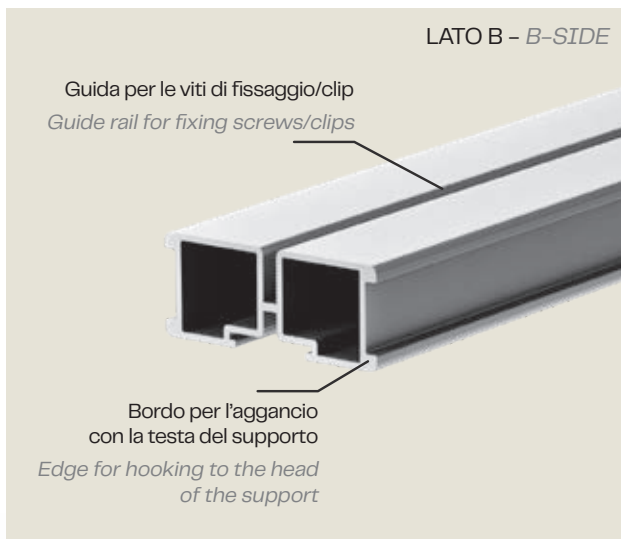
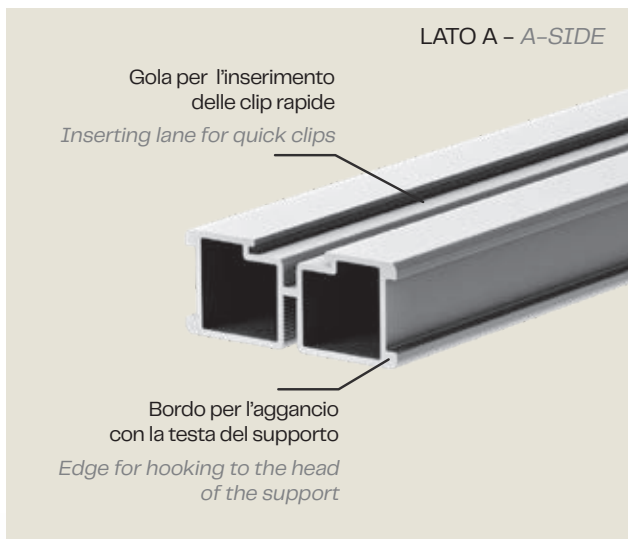

 Alluminio Naturale
Aluminium natural

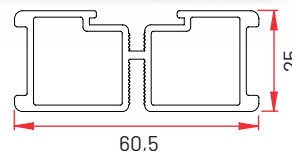

Il travetto in alluminio è una struttura che abbinata ai supporti della linea Woodeck, consente di posare sia lastre di ceramica, anche multiformato, che listoni in legno o WPC. I bordi laterali sono opportunamente arrotondati per consentire l'aggancio a scatto sulle apposite teste disponibili per tutte le versioni del sistema sopraelevato. Questo travetto può essere usato su entrambi i lati. Il "binario" presente sul **lato A** consente l'inserimento di una clip in polipropilene a croce, la quale funge da aletta distanziatrice per la posa delle lastre in ceramica, inoltre consente l'inserimento anche di una clip in acciaio inox per la posa dei listoni in legno o WPC. Sul **lato B** si possono applicare le clip doppie con doppia vite di fissaggio per la posa dei listoni in legno o WPC.

The aluminum joist is a structure that, when paired with supports from the Woodeck line, allows for the installation of both ceramic slabs, even in various formats, and wooden or WPC planks. The lateral edges are appropriately rounded to enable snap engagement onto the dedicated heads available for all versions of the raised flooring system. This joist can be used on both sides. The "track" present on **A side** allows for the insertion of a polypropylene slab spacer clip, which serves as a spacing element for laying ceramic slabs. Additionally, it also allows for the insertion of double clip with fixed screws for laying wooden or WPC planks. On **B side**, double clips with double fastening screws can be applied for the installation of wooden or WPC planks.

CODICE CODE	DESCRIZIONE DESCRIPTION	COLORE COLOR	MISURA SIZE	PAG. LISTINO PRICE LIST PAGE	MT 
Q231020025	Standard Aluminium joist	Alluminio naturale Aluminium natural	sezione 60x25 mm L. 2000 mm 60x25 mm section L. 2000 mm	72	192

Travetto in alluminio a deflusso rapido

Aluminium joist for rapid flow

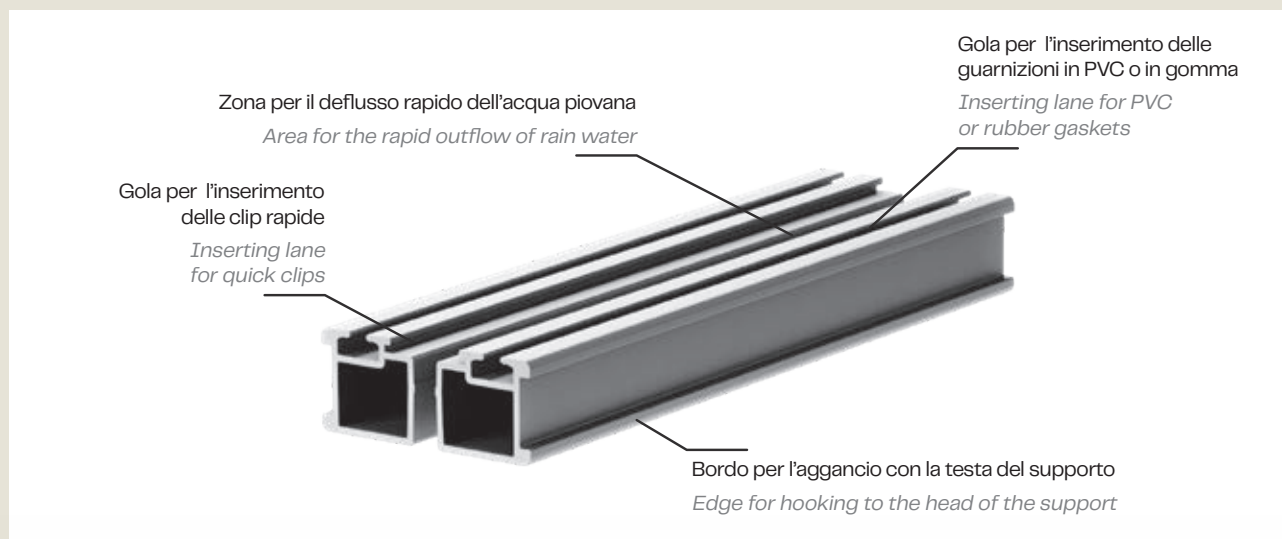

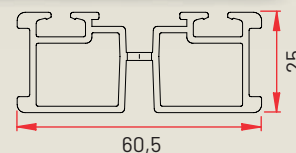

 Alluminio Naturale
Aluminium natural

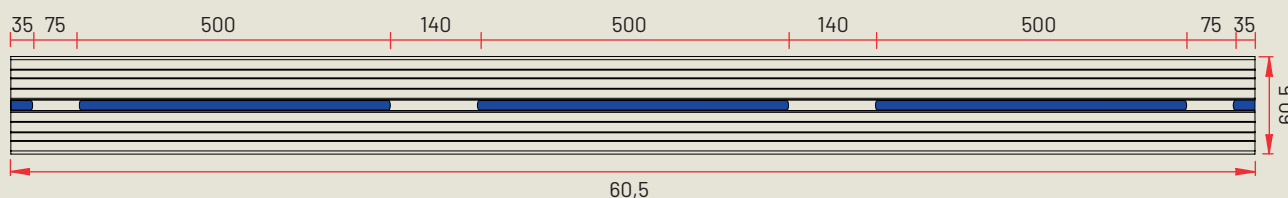

Questo travetto in alluminio mantiene tutte le caratteristiche del travetto in alluminio standard, inoltre grazie alle grandi feritoie presenti nella parte centrale consente il rapido deflusso dell'acqua meteorica nel caso della posa di lastre in ceramica.

This aluminium joist maintains all the characteristics of the standard aluminium joist, also thanks to the large slits in the central part it allows the rapid flow of rainwater in the case of laying ceramic slabs.



CODICE CODE	DESCRIZIONE DESCRIPTION	COLORE COLOR	MISURA SIZE	PAG. LISTINO PRICE LIST PAGE	MT 
Q231420026	A deflusso rapido <i>Rapid flow</i>	Alluminio naturale <i>Aluminium natural</i>	sezione 60x25 mm L. 2000 mm <i>60x25 mm section L. 2000 mm</i>	72	192

Travetto in alluminio ECO standard

ECO standard aluminium joist

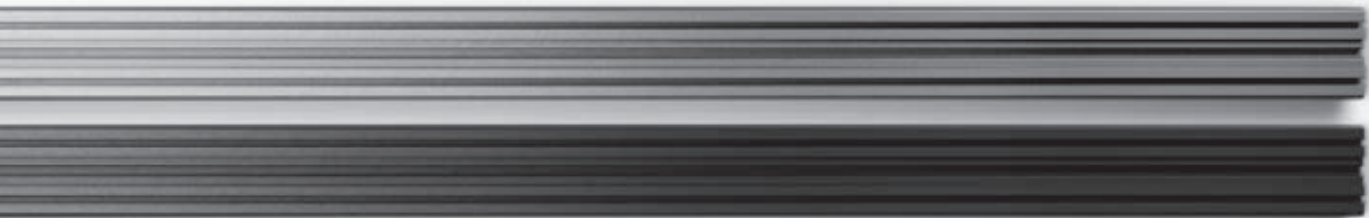
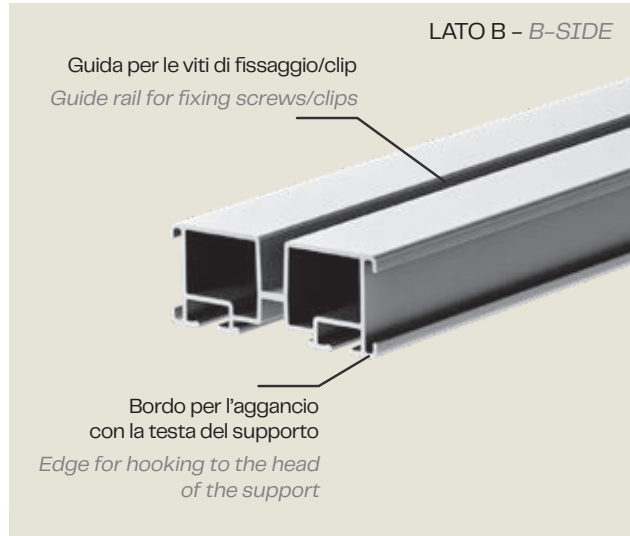
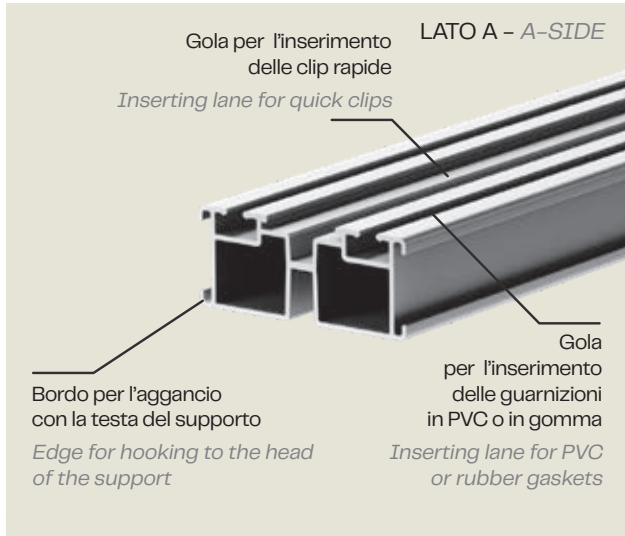

Alluminio Naturale
Aluminium natural



Nero
Black

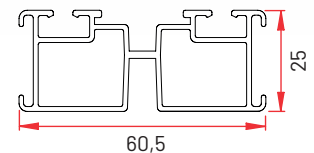

Questo travetto può essere usato su entrambi i lati. Il "binario" presente sul **lato A** consente l'inserimento di una clip in polipropilene a croce, la quale funge da aletta distanziatrice per la posa delle lastre in ceramica, o l'inserimento anche di una clip in acciaio inox per la posa dei listoni in legno o WPC.

Sul **lato B** si possono applicare le clip doppie con doppia vite di fissaggio per la posa dei listoni in legno o WPC.

*This joist can be used on both sides. The "track" present on **A side** allows for the insertion of a polypropylene slab spacer clip, which serves as a spacing element for laying ceramic slabs.*

Additionally, it also allows for the insertion of double clip with fixed screws for laying wooden or WPC planks.

*On **B side**, double clips with double fastening screws can be applied for the installation of wooden or WPC planks.*

CODICE CODE	DESCRIZIONE DESCRIPTION	COLORE COLOR	MISURA SIZE	PAG. LISTINO PRICE LIST PAGE	MT
Q231020020	ECO standard ECO standard	Alluminio naturale Aluminium natural	sezione 60x25 mm L. 2000 mm	73	192
Q231020020.N		Nero Black	60x25 mm section L. 2000 mm		

Travetto in alluminio ECO a deflusso rapido

ECO aluminium joist for rapid flow

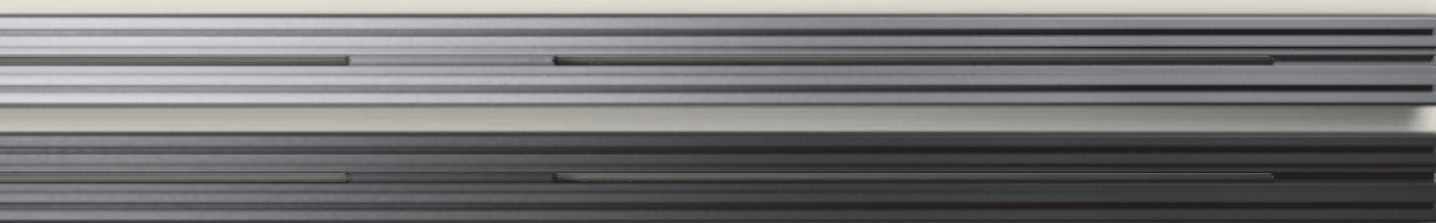
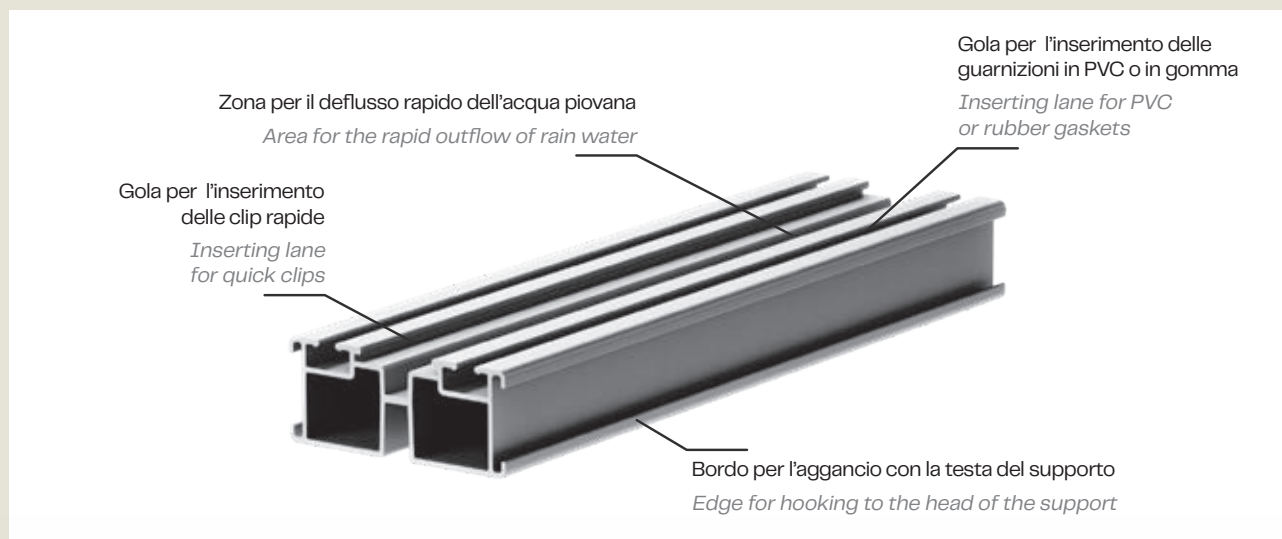

Alluminio Naturale
Aluminium natural



Nero
Black

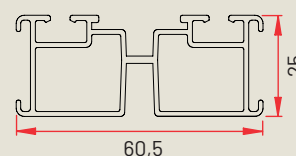

Adatto per la posa di lastre in ceramica autoportanti mono e multiformato o listoni in ceramica e legno (decking) con clip rapide Eterno Ivica.

Suitable for laying single and multi-size self-supporting ceramic slabs or planks in ceramic and wood (decking) with Eterno Ivica quick clips.

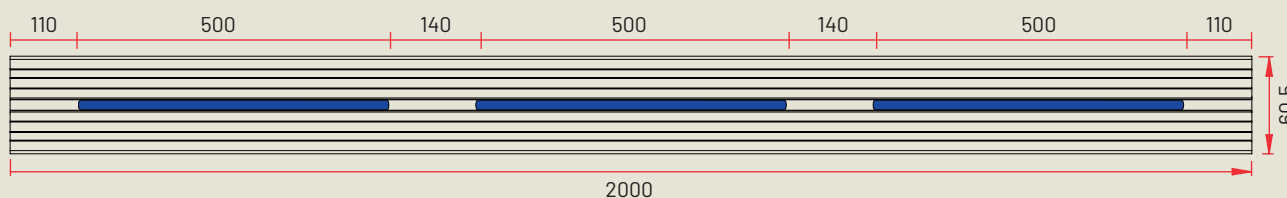

CODICE CODE	DESCRIZIONE DESCRIPTION	COLORE COLOR	MISURA SIZE	PAG. LISTINO PRICE LIST PAGE	MT
Q231020021	ECO a deflusso rapido <i>ECO for rapid flow</i>	Alluminio naturale <i>Aluminium natural</i>	sezione 60x25 mm L. 2000 mm <i>60x25 mm section L. 2000 mm</i>	73	192
Q231020021.N		Nero <i>Black</i>			

Giunto per travetto in alluminio standard

Standard aluminium joist joint

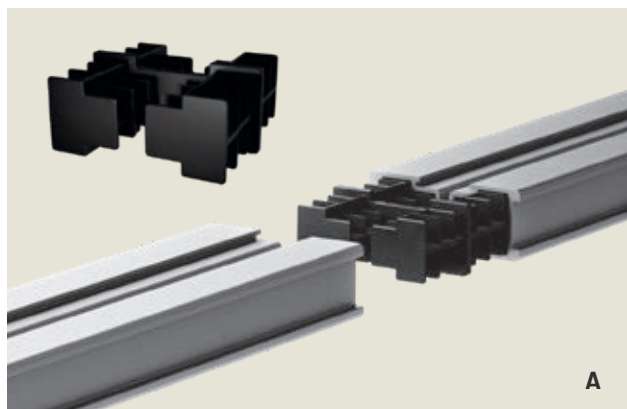

Il giunto per travetti Eterno Ivica è un prodotto non strutturale, funge pertanto solo da collegamento tra i vari travetti per evitare eventuali sfalsi. Realizzato in polipropilene di colore nero, può essere utilizzato sia su travetti a sbalzo che su travetti appoggiati sulla testa. Esso presenta lo spazio per l'aggancio dei denti. È semplice da utilizzare e veloce, si inserisce infatti il giunto nel primo travetto, portandolo in battuta con il travetto stesso, successivamente si inserisce il secondo travetto.

The Eterno Ivica joist joint is a non-structural product, therefore it only acts as a connection between various joists to avoid any displacement. Made of black polypropylene, it can be used both on cantilever beams and on rafters resting on the head. It presents the space for hooking the teeth. It is easy to use and fast, one inserts the joint in the first joist, bringing it into contact with the beam itself, then one inserts the second joist.

Giunto per travetto in alluminio a deflusso rapido, ECO standard e ECO a deflusso rapido

Rapid flow, ECO standard and ECO for rapid flow aluminium joint joist

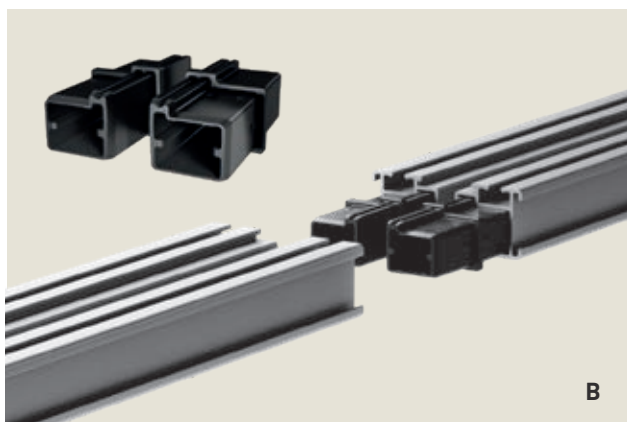

Il giunto di raccordo per travetto a deflusso rapido non è un prodotto "strutturale", funge solo da collegamento tra i vari travetti. È realizzato in Polipropilene di colore nero, è semplice e veloce da utilizzare inserendosi facilmente nelle teste dei travetti.

The rapid flow joist connection joint is not a "structural" product, it only acts as a connection between the various joists. It is made of black polypropylene, it is quick and easy to use by easily inserting into the heads of the joists.

CODICE CODE	TIPO TYPE	DESCRIZIONE DESCRIPTION	COMPATIBILITÀ TRAVETTO JOIST COMPATIBILITY	PAG. LISTINO PRICE LIST PAGE	PZ
Q200000025	A	Giunto di raccordo <i>Joist joint</i>	Standard	72	200
Q200000026	B	Giunto di raccordo <i>Joist joint</i>	Deflusso rapido - ECO standard ECO a deflusso rapido <i>Rapid flow - ECO standard ECO for rapid flow</i>	73	200

Gomma antirumore Noise insulating rubber



Disponibile in pratici rotoli, il nastro adesivo in gomma antirumore si posiziona sui travetti in alluminio per l'intera lunghezza degli stessi, o nei punti scelti, al fine di evitare il contatto diretto fra le lastre e il metallo.

It is available in practical rolls, the adhesive tape in noise insulating rubber can be placed on the aluminium joists for the entire length or in the chosen points, in order to avoid direct contact between the slabs and the metal.

Guarnizione in PVC PVC gasket



La guarnizione in PVC per travetto a deflusso rapido si posiziona negli appositi inviti predisposti nel senso longitudinale del travetto, ha la funzione di evitare il contatto diretto tra travetto e lastre o listoni. È fornito in rotolo da 50 e 200 mt.

The PVC gasket for rapid flow joist is positioned in the special notches arranged in the longitudinal direction of the joist, it has the function of avoiding direct contact between the joist and slabs or planks. It is supplied in rolls of 50 and 200 meters.

CODICE CODE	DESCRIZIONE DESCRIPTION	COMPATIBILITÀ TRAVETTO JOIST COMPATIBILITY	MISURA SIZE	PAG. LISTINO PRICE LIST PAGE	PZ
V13052100	Gomma antirumore <i>Noise insulating rubber</i>	Standard - Deflusso rapido ECO standard - ECO a deflusso rapido <i>Standard - Rapid flow ECO standard - Rapid flow ECO</i>	15x2 mm	74	Rotolo da 10 mt <i>10 mt roll</i>
V13052205	Guarnizione in PVC <i>PVC gasket</i>	Deflusso rapido - ECO standard ECO a deflusso rapido <i>Rapid flow - ECO standard ECO for rapid flow</i>	-	74	Rotolo da 50 mt <i>50 mt roll</i>
V13052200					Rotolo da 200 mt <i>200 mt roll</i>

Distanziatore (clip) a croce con alette

4 mm H 12 mm



Slab spacers for aluminium joist 4 mm thick tabs, H 12 mm

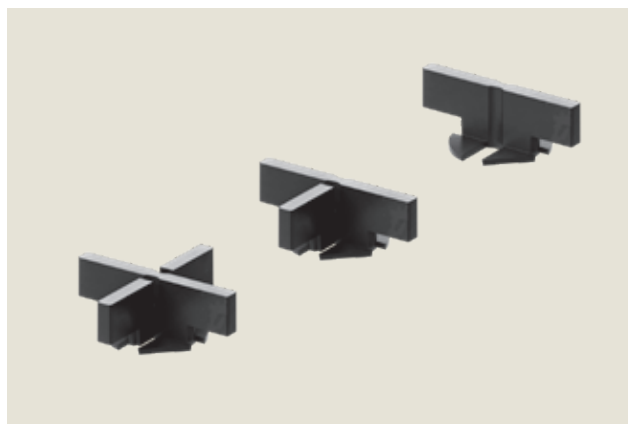

Il Distanziatore è studiato per mantenere lastre mono e multiformato e listoni in ceramica nella corretta posizione e creare la fuga. È utilizzabile nella sua forma originale "a croce" o facilmente adattabile a forma di "T" o di "I", a seconda della geometria delle fughe da realizzare. La clip ha una configurazione che permette l'inserimento in un punto qualsiasi del travetto rimanendo nel suo alloggiamento senza fuoriuscire dalla sede.

È utilizzabile con lastre di ceramica mono e multiformato.

The Slab Spacers is designed to keep the single and multiformat slabs and ceramic planks in the correct location and create the escape. It is used in its original form or easily adaptable to the form of "T" or "I", depending on the geometry of the joints to achieve.

The clip has a configuration that allows the insertion at any point of the joist remaining in its housing without coming out of their housing.

It can be used with both single-format and multi-format ceramic slabs.

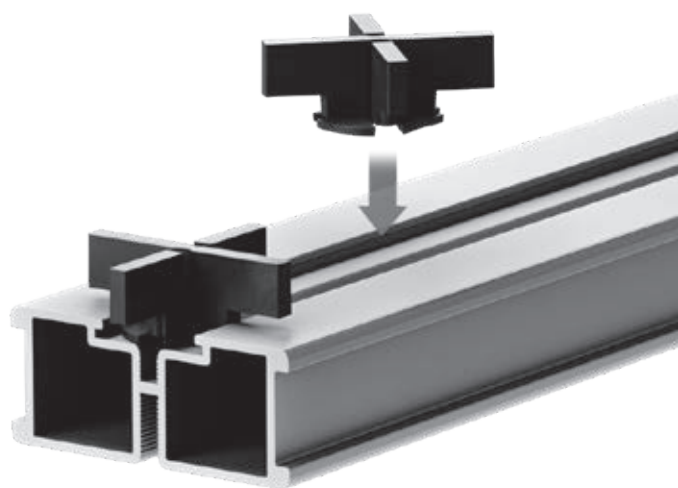

CODICE CODE	DESCRIZIONE DESCRIPTION	MISURA SIZE	PAG. LISTINO PRICE LIST PAGE	PZ 
E004000104	Distanziatore per travetti in alluminio aletta 4 mm H 12 mm* <i>Slab spacers for aluminium joist 4 mm thick tabs, H 12 mm*</i>	42x42 mm	74	1000**

* Alette distanziatrici spessore 2 o 3 mm disponibili su richiesta.

** All'interno del box sono presenti 2 confezioni da n. 500 pezzi.

* Spreader tabs 2 or 3 mm thick available on request.

** Inside the box are 2 packages of 500 pieces.

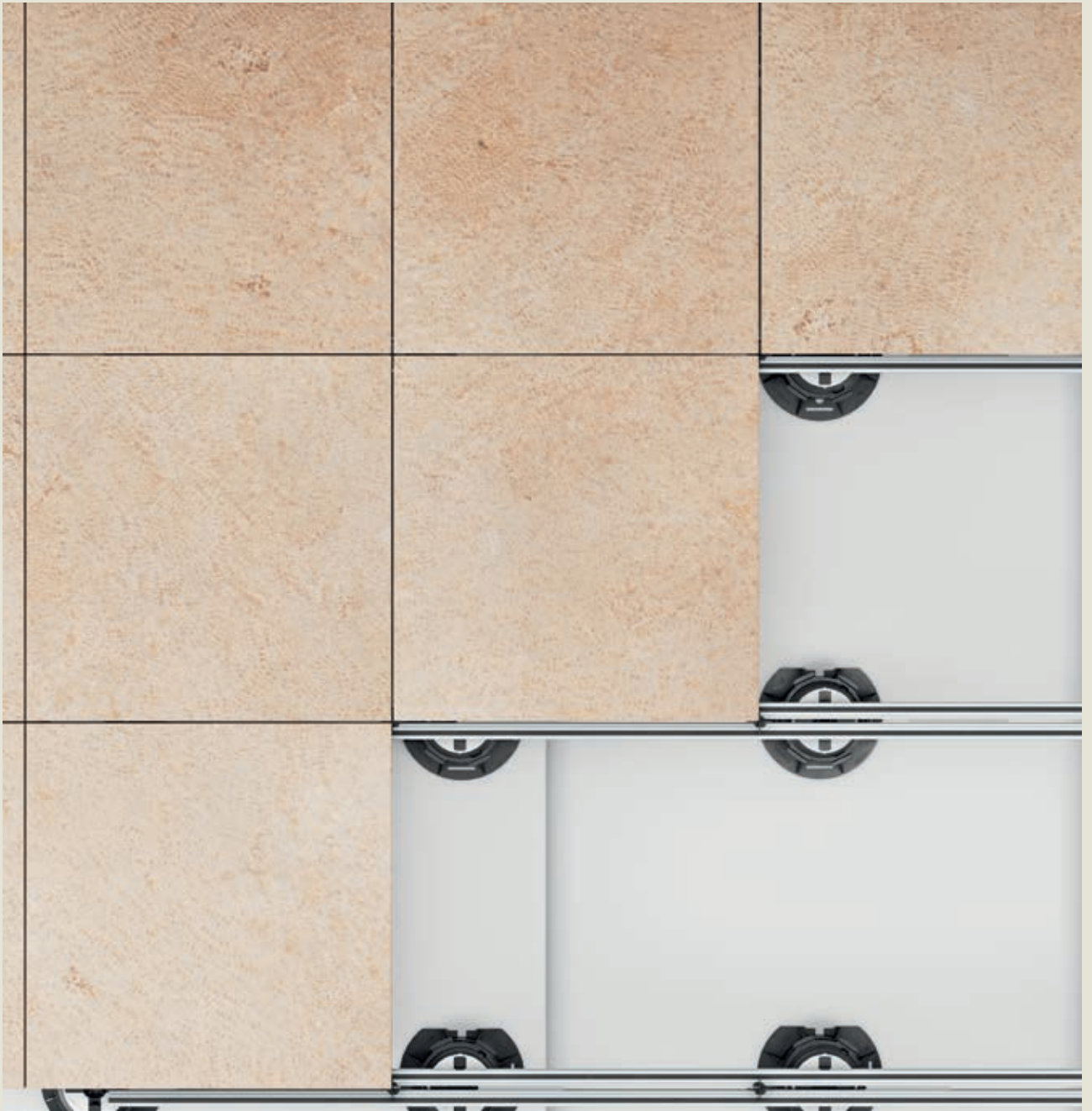

Clip di testa con vite di fissaggio

Head clip with fixing screw

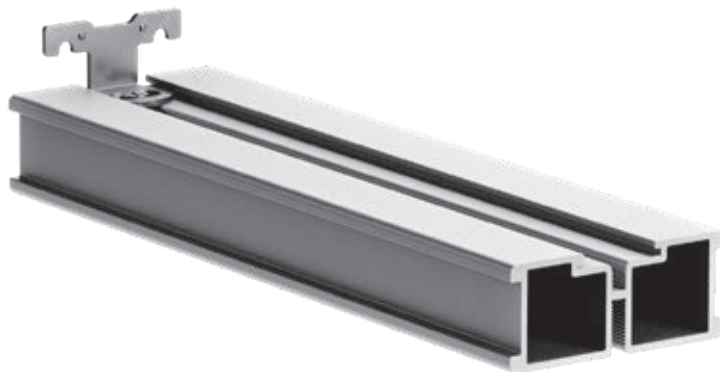

CODICE CODE	DESCRIZIONE DESCRIPTION	MISURA SIZE	PAG. LISTINO PRICE LIST PAGE	PZ*
Q200000240	Clip di testa <i>Head clip</i>	H 19,2 mm	75	1

* La clip di testa comprende la relativa vite di fissaggio diametro 3,9 mm - L 19 mm.

* The head clip includes the corresponding fixing screw diameter 3,9 mm - L 19 mm.

Clip singola

Single clip

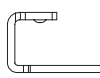

N. 1 clip singola 90°
N. 1 single clip 90°

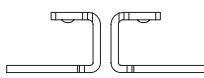

N. 2 clip singole 90°
N. 2 double clip 90°

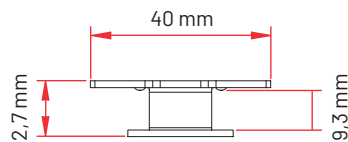

N. 1 clip singola 110°
N. 1 single clip 110°

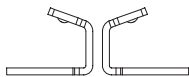

N. 2 clip singole 110°
N. 2 double clip 110°

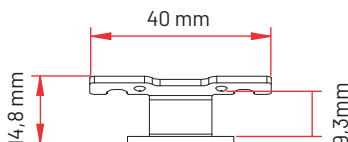

CODICE CODE	DESCRIZIONE DESCRIPTION	PAG. LISTINO PRICE LIST PAGE	PZ*
Q200000232	Clip singola 90° <i>Single clip 90°</i>	75	50
Q200000231	Clip singola 110° <i>Single clip 110°</i>	75	50

* Le confezioni da 50 clip comprendono n. 25 viti di fissaggio diametro 3,9 mm - L 19 mm.

* 50 clips packages include 25 fixing screws 3,9 mm - L 19 mm diameter.

Quote per cava listone

Measurements for plank lane



Clip singola 90° - Single clip 90° (Q200000232)

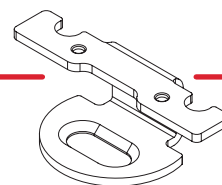

Lato superiore listone - Top side plank

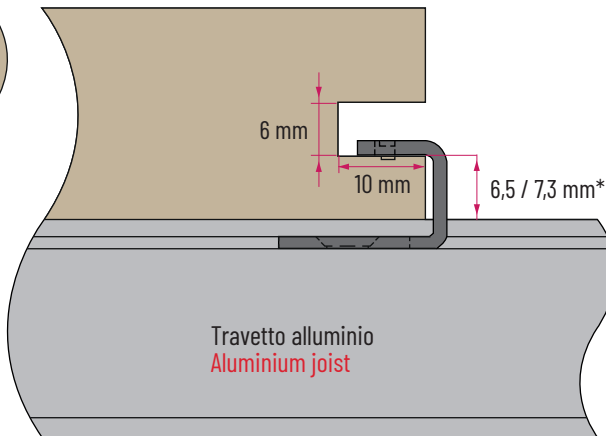
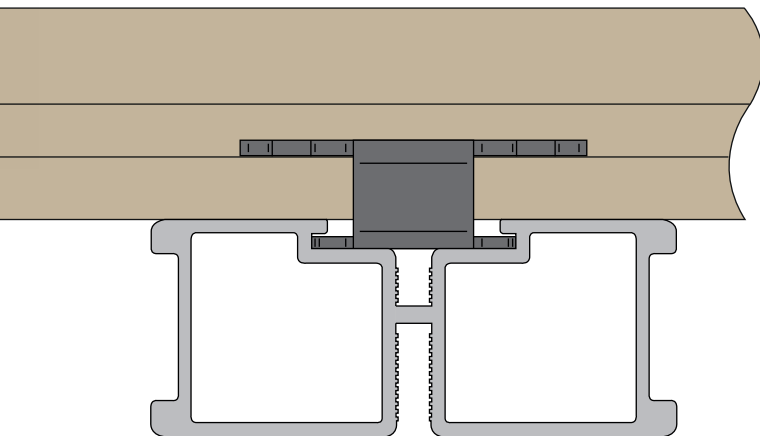

* 6,5 mm se il listone è posato sulla gomma antirumore o guarnizione in PVC. 7,3 mm se il listone è posato direttamente a contatto con l'alluminio.

* 6,5 mm if the plank is laid on top of the sound absorbing rubber or a PVC gasket. 7,3 mm if the plank is laid in direct contact with the aluminium.



Clip singola 110° - Single clip 110° (Q200000231)

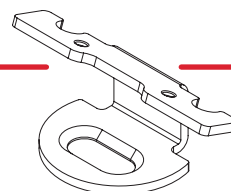

Lato superiore listone - Top side plank

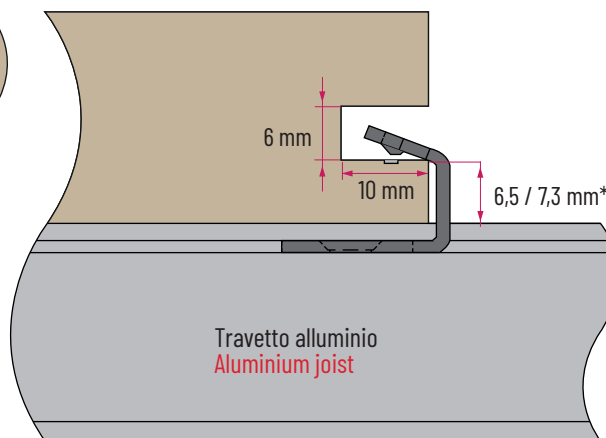
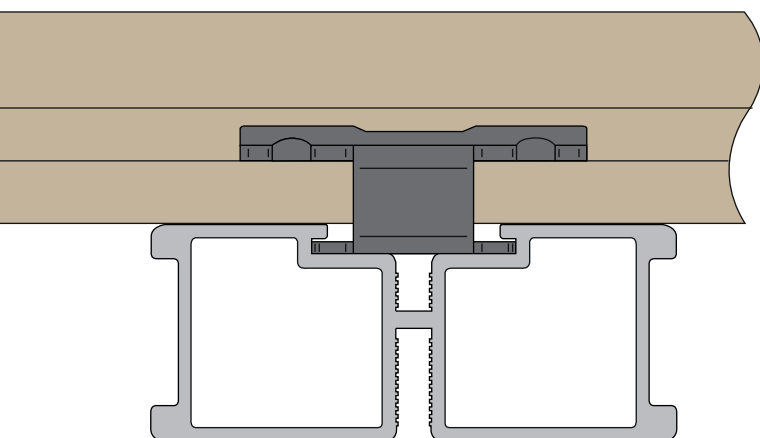

* 6,5 mm se il listone è posato sulla gomma antirumore o guarnizione in PVC. 7,3 mm se il listone è posato direttamente a contatto con l'alluminio.

* 6,5 mm if the plank is laid on top of the sound absorbing rubber or a PVC gasket. 7,3 mm if the plank is laid in direct contact with the aluminium.

Clip doppia

Double clip

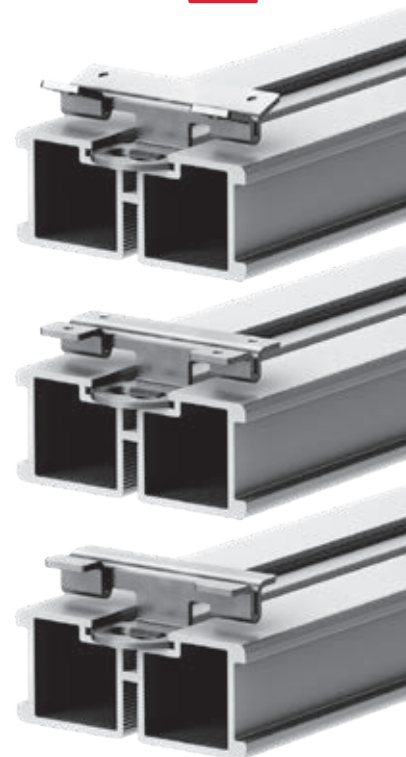
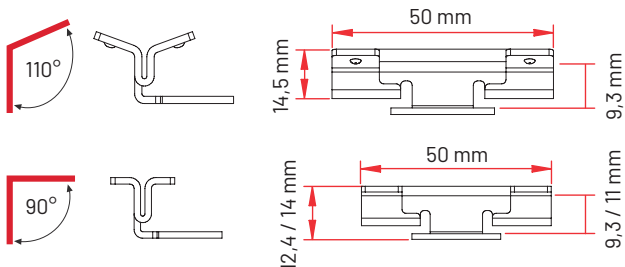

CODICE CODE	DESCRIZIONE DESCRIPTION	MISURA SIZE	PAG. LISTINO PRICE LIST PAGE	PZ*
Q200000265	Clip doppia 110° Double clip 110°	50 x 26 x 14,5 mm	76	100
Q200000260	Clip doppia 90° Double clip 90°	50 x 26 x 12,4 mm	76	100
Q200000261	Clip doppia 90° Double clip 90°	50 x 26 x 14,0 mm	76	100

* Le confezioni da 100 clip comprendono n. 25 viti di fissaggio diametro 3,9 mm - L 19 mm.

* 100 clips packages include 25 fixing screws 3,9 mm - L 19 mm diameter.

Clip doppia 110° - Double clip 110° (Q200000265)

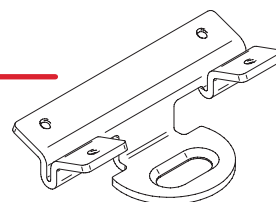
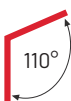

Lato superiore listone - Top side plank

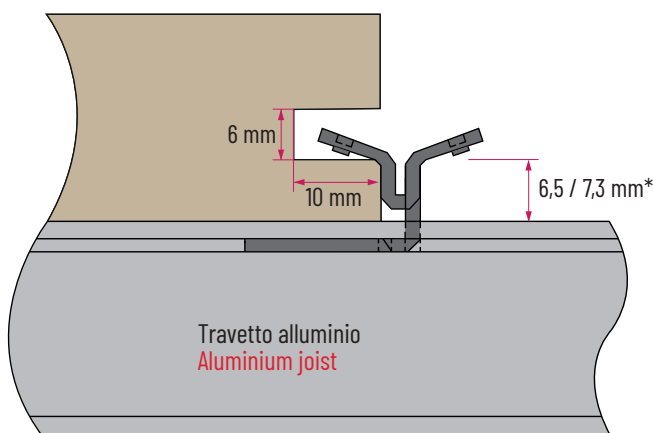
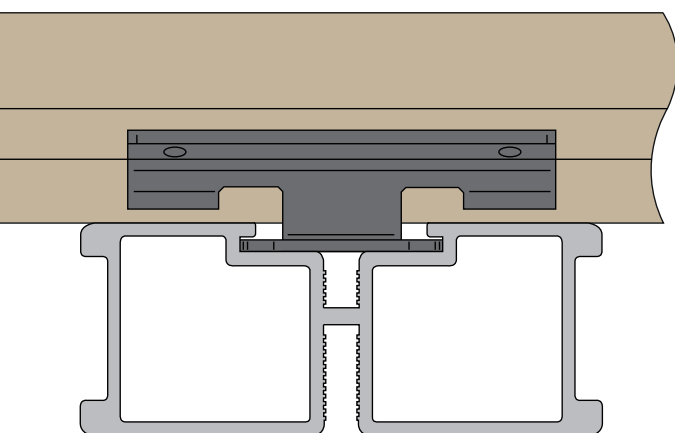

* 6,5 mm se il listone è posato sulla gomma antirumore o guarnizione in PVC. 7,3 mm se il listone è posato direttamente a contatto con l'alluminio.

* 6,5 mm if the plank is laid on top of the sound absorbing rubber or a PVC gasket. 7,3 mm if the plank is laid in direct contact with the aluminium.

Quote per cava listone

Measurements for plank lane



Clip doppia 90° - Double clip 90° (Q200000260)

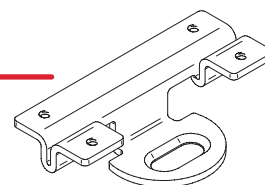

Lato superiore listone - Top side plank

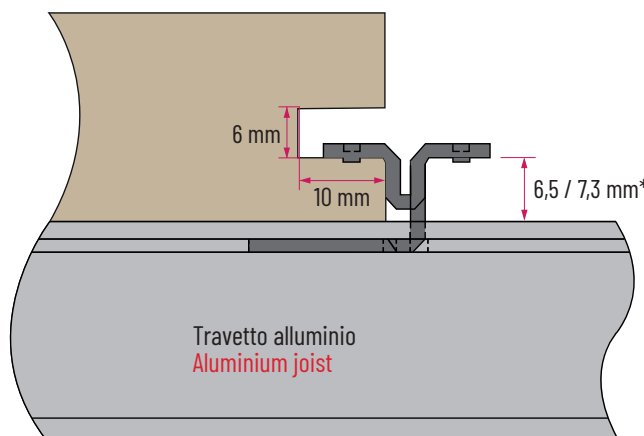
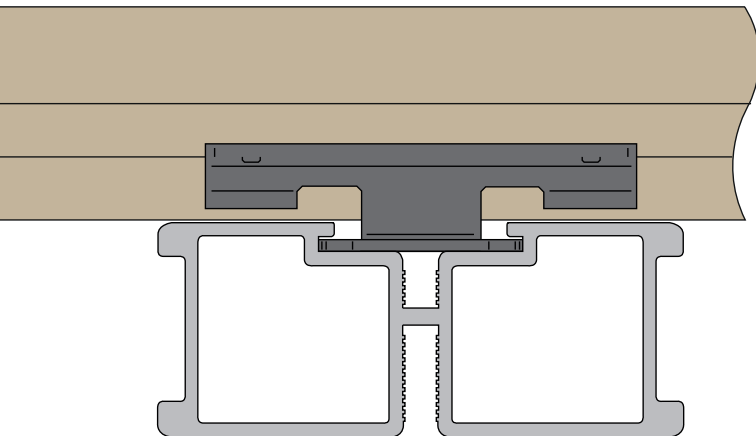

* 6,5 mm se il listone è posato sulla gomma antirumore o guarnizione in PVC. 7,3 mm se il listone è posato direttamente a contatto con l'alluminio.

* 6,5 mm if the plank is laid on top of the sound absorbing rubber or a PVC gasket. 7,3 mm if the plank is laid in direct contact with the aluminium.



Clip doppia 90° - Double clip 90° (Q200000261)

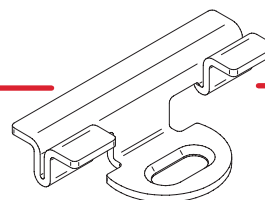

Lato superiore listone - Top side plank

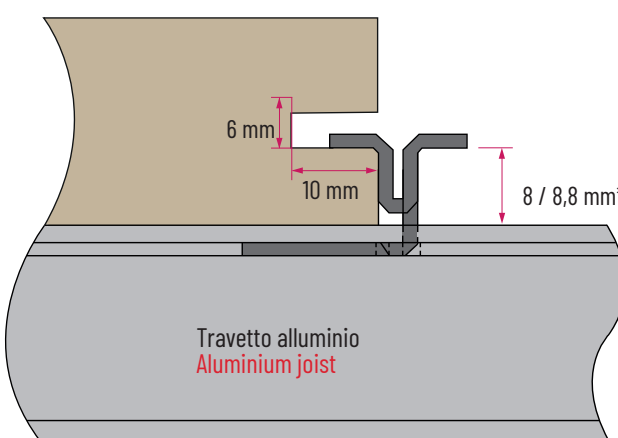
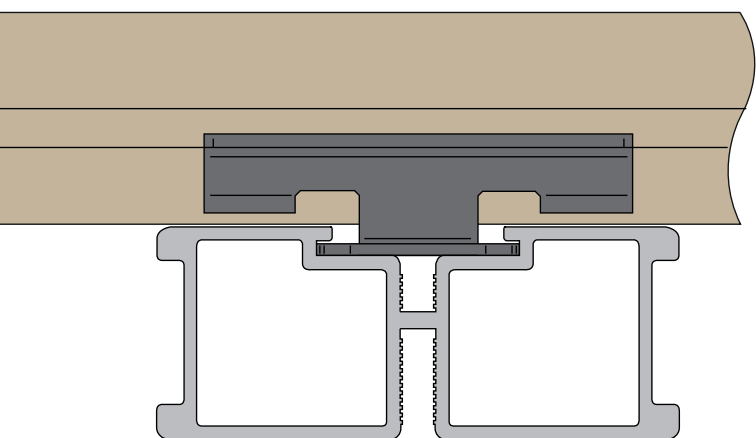

* 8 mm se il listone è posato sulla gomma antirumore o guarnizione in PVC. 8,8 mm se il listone è posato direttamente a contatto con l'alluminio.

* 8 mm if the plank is laid on top of the sound absorbing rubber or a PVC gasket. 8,8 mm if the plank is laid in direct contact with the aluminium.

Clip doppia con doppia vite di fissaggio

Double clip with fixing screws

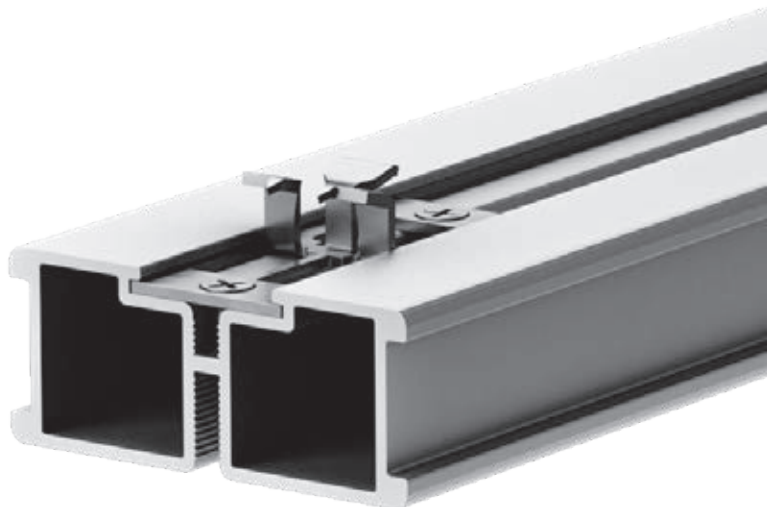
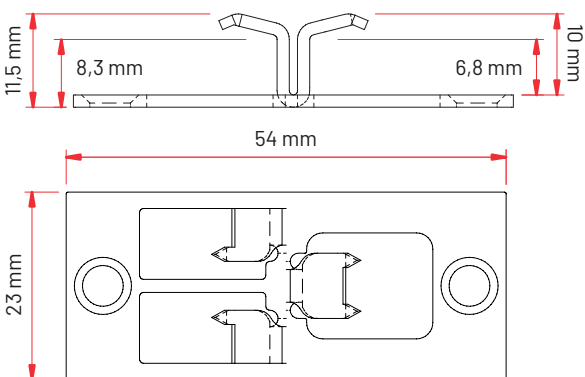

Lato A del travetto standard ed ECO standard
A-Side of the standard and ECO standard joist

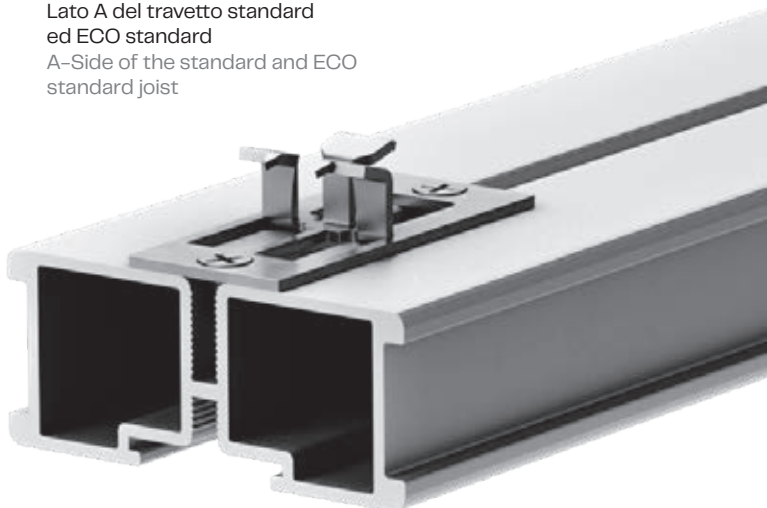

Lato B del travetto standard ed ECO standard
B-Side of the standard and ECO standard joist

CODICE CODE	DESCRIZIONE DESCRIPTION	MISURA SIZE	PAG. LISTINO PRICE LIST PAGE	PZ*
Q200000008	Clip doppia con doppia vite di fissaggio <i>Double clip with fixing screws</i>	54 x 23 x 11,5 mm	75	100

* La confezione da 100 clip comprende n. 200 viti di fissaggio diametro 2,9 mm – L 22 mm.

* The pack of 100 clips includes 200 fastening screws with a diameter of 2,9 mm and a length of 22 mm.

Quote per cava listone Measurements for plank lane

Clip doppia con doppia vite di fissaggio Double clip with fixing screws (Q200000008)

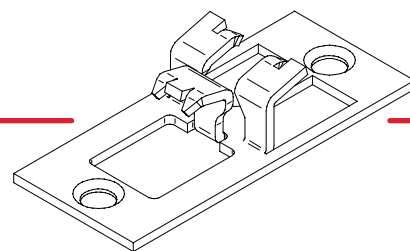

Travetto lato A (clip inserita nella cava) A-side joist (clip inserted in lifter)

Lato superiore listone - Top side plank

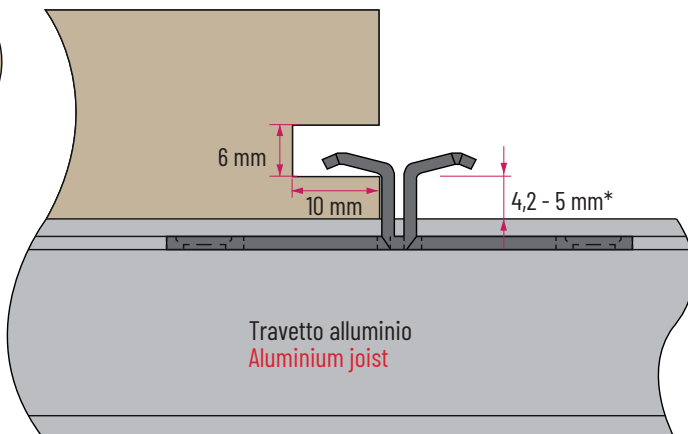
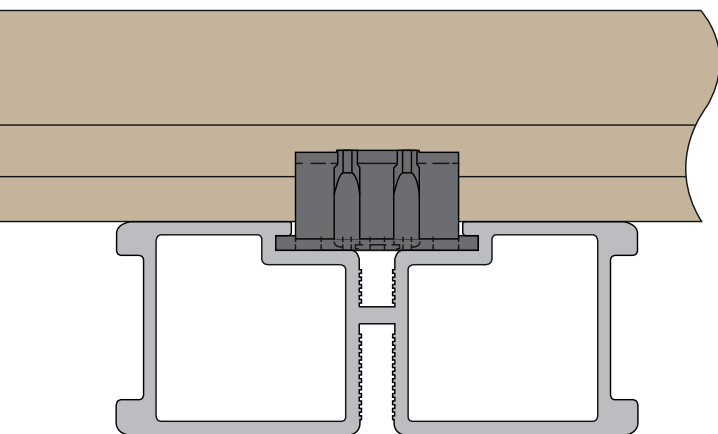

* 4,2 mm se il listone è posato sulla gomma antirumore o guarnizione in PVC. 5 mm se il listone è posato direttamente a contatto con l'alluminio.

* 4,2 mm if the plank is laid on the anti-noise rubber or PVC gasket. 5 mm if the plank is laid directly in contact with the aluminum.

Travetto lato B (clip in appoggio) B-side joist (clip on)

Lato superiore listone - Top side plank

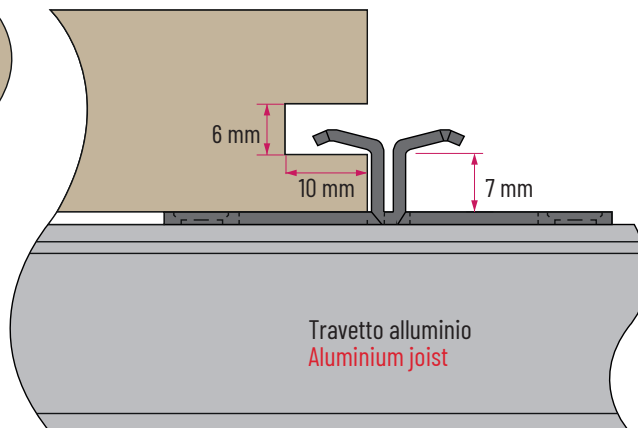
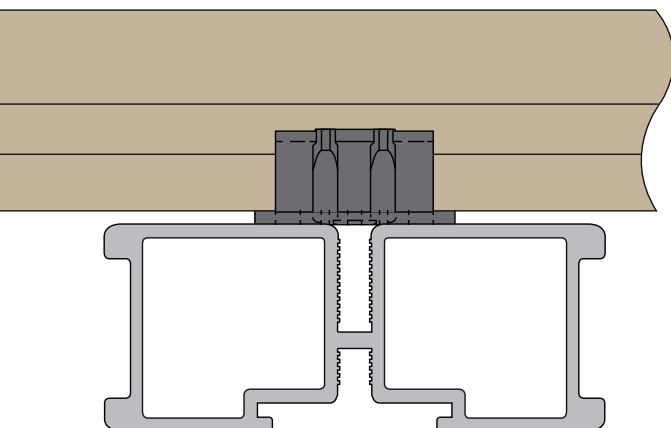

Clip tamponamento verticale per posa lastre in ceramica monoformato, multiformato e listoni in ceramica



Vertical lining clip for laying single, multi-size ceramic slabs and planks



Installazione tamponamento verticale con travetto in alluminio



Vertical infill installation with aluminium joist



Clip per tamponamento verticale testa
Upper clip for vertical closure



Clip per tamponamento verticale base
Lower clip for vertical closure

Questa soluzione è composta da due particolari clip in acciaio inox, conformate in modo da accoppiarsi perfettamente con il travetto in alluminio e sotto la base del supporto Eterno Ivica.

In questo modo si crea l'aggancio a cui si fisserà il tamponamento verticale opportunamente dimensionato. È disponibile per lastre con spessore 20, 30 e 40 mm.

This solution consists of two particular stainless steel clips, properly shaped as to perfectly fit with the aluminium joist and under the base of the Eterno Ivica support. This creates the coupling to which the suitably sized infill board will be fixed.

It is available for 20, 30 and 40 mm thick slabs.

CODICE CODE	DESCRIZIONE DESCRIPTION	COMPATIBILITÀ SUPPORTI COMPATIBILITY SUPPORTS	Ø TESTA SUPPORTI Ø HEAD SUPPORTS	SPESSORE LASTRA* SLAB THICK- NESS*	PAG. LISTINO PRICE LIST PAGE	PZ
P021000722	Clip testa Head clip	SRT - SE - NM - SB	110 mm	20 mm	76	100
		SRT	150 mm			
P021000822	Clip testa Head clip	PR - NM con base a rottura facilitata PR - NM with easy break base	110 mm	20 mm	76	100
P021000322	Clip base Base Clip	PR - SRT - SE - NM - SB	110 mm	20 mm	76	100
		SRT	150 mm			

* Disponibili anche per lastre spessore 30-40 mm

** Also available for 30-40 mm thick slabs*



Clip tamponamento angolare per posa lastre in ceramica monoformato, multiformato e listoni in ceramica

Angular lining clip for laying single, multi-size ceramic slabs and planks

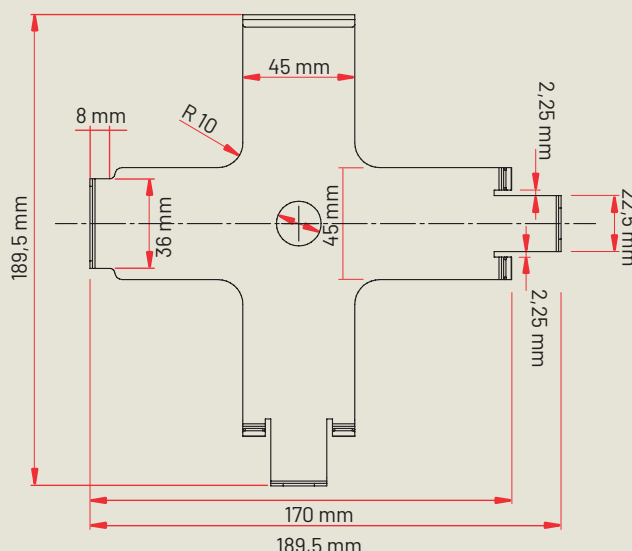
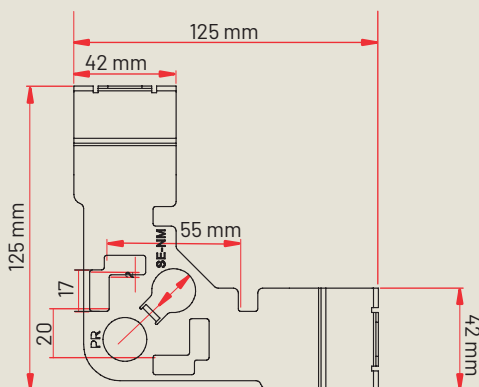

Questa particolare CLIP, sia di Testa che di Base, viene impiegata nel caso di un tamponamento verticale ad “angolo”, anziché utilizzare due clip di Testa e due clip di Base si utilizza una unica clip di Testa e una unica clip di Base. È realizzata in acciaio inox, semplice e veloce da installare.

This particular CLIP, both Head and Base, is used in the case of a vertical “corner” infill, instead of using two Head clips and two Base clips, a single Head clip and a single Base clip are used. It is made of stainless steel, simple and quick to install.

CODICE CODE	DESCRIZIONE DESCRIPTION	COMPATIBILITÀ SUPPORTI COMPATIBILITY SUPPORTS	Ø TESTA SUPPORTI Ø HEAD SUPPORTS	SPESSORE LASTRA SLAB THICKNESS	PAG. LISTINO PRICE LIST PAGE	PZ
P021000952	Clip testa Head clip	PR - SE - NM - SB	110 mm	20 mm	77	25
P021000952.N	Clip testa Head clip	SRT	110 - 150 mm	20 mm	77	25
P021000912	Clip base Base Clip	PR - SRT - SE - NM - SB	110 mm	20 mm	77	25
		SRT	150 mm			

* Disponibili anche per lastre spessore 30-40 mm

** Also available for 30-40 mm thick slabs*

Clip tamponamento verticale per posa listoni in legno/WPC (decking)

Vertical lining clip for laying wooden/WPC planks (decking)



- 1 Pavimentazione in legno, WPC o altro materiale
Wooden or other material floors
- 2 Travetto in alluminio
Aluminium joist
- 3 Clip di testa per tamponamento verticale
Head clip for vertical infill
- 4 Supporto regolabile
Adjustable support
- 5 Clip base per tamponamento verticale
Base clip for vertical infill
- 6 Clip per travetto in alluminio
Clip for aluminium joist



CODICE CODE	DESCRIZIONE DESCRIPTION	COMPATIBILITÀ SUPPORTI COMPATIBILITY SUPPORTS	Ø TESTA SUPPORTI Ø HEAD SUPPORTS	PAG. LISTINO PRICE LIST PAGE	PZ
P021000430	Clip testa <i>Head Clip</i>	SE - NM - SB	110 mm	77	100
P021000430.N	Clip testa <i>Head Clip</i>	SRT	110 - 150 mm	77	100
P021000432	Clip testa <i>Head Clip</i>	PR - NM con base a rottura facilitata <i>PR - NM with easy break base</i>	110 mm	77	100
P021000322	Clip base <i>Base clip</i>	PR - SRT - SE - NM - SB	110 mm	77	100
		SRT	150 mm		

Clip tamponamento verticale angolare per posa listoni in legno/WPC (decking)

Vertical angular lining clip for laying wooden/WPC planks (decking)



Testa - Head



Base - Base

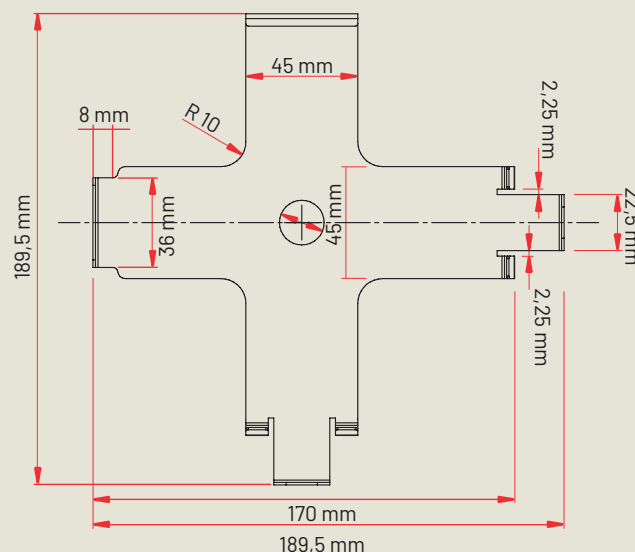
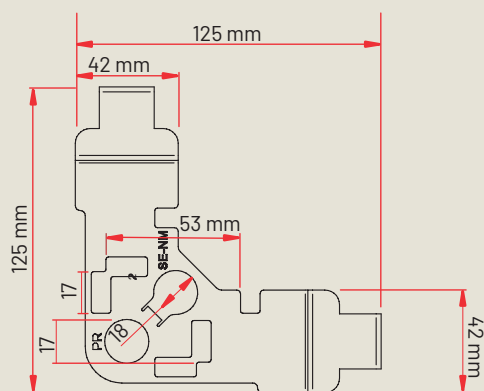

Questa particolare CLIP, sia di Testa che di Base, viene impiegata nel caso di un tamponamento verticale ad "angolo", anziché utilizzare due clip di Testa e due clip di Base si utilizza una unica clip di Testa e una unica clip di Base. È realizzata in acciaio inox, semplice e veloce da installare.

This particular CLIP, both Head and Base, is used in the case of a vertical "corner" infill, instead of using two Head clips and two Base clips, a single Head clip and a single Base clip are used. It is made of stainless steel, simple and quick to install.

CODICE CODE	DESCRIZIONE DESCRIPTION	COMPATIBILITÀ SUPPORTI COMPATIBILITY SUPPORTS	Ø TESTA SUPPORTI Ø HEAD SUPPORTS	PAG. LISTINO PRICE LIST PAGE	PZ
P021000932	Clip testa Head clip	PR - SRT - SE - NM - SB	110 mm	77	25
		SRT	150 mm		
P021000912	Clip base Base clip	PR - SRT - SE - NM - SB	110 mm	77	25
		SRT	150 mm		

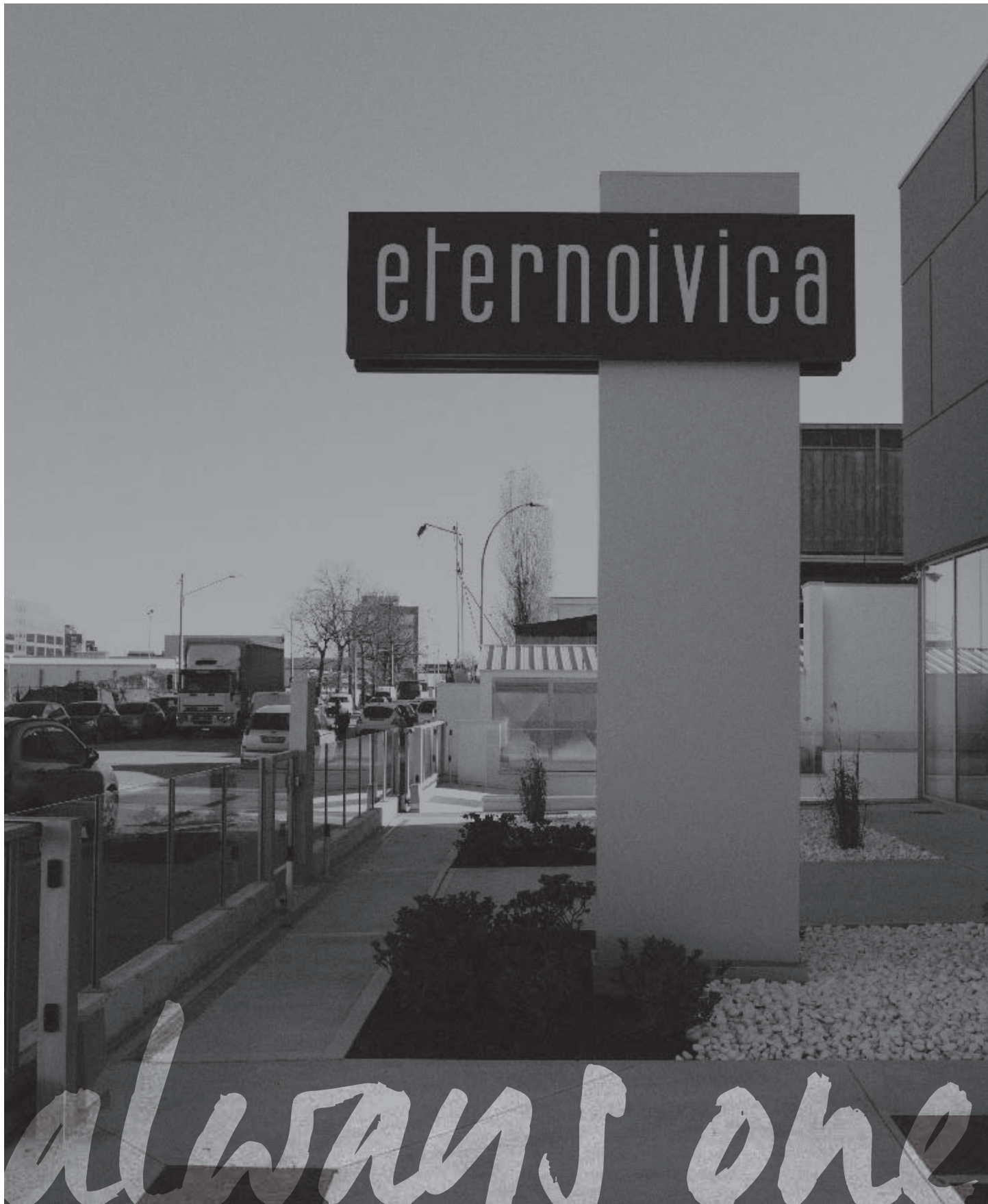

almanj one

SOFTWARE, SERVIZI E PACKAGING

SOFTWARE, SERVICES
AND PACKAGING

step ahead

Software di calcolo

Calculation software



Eterno Ivica ha sviluppato e reso disponibile l'innovativo software "PEDESTAL", un programma che permette in maniera semplice, veloce e precisa, di calcolare il numero e il tipo di supporti necessari per realizzare una pavimentazione sopraelevata in base a forma, geometria e superficie della pavimentazione da realizzare e alla tipologia di rivestimento scelto.

Compilando un semplice form, dove poter inserire i dati caratteristici del lavoro da effettuare quali a esempio il perimetro del pavimento, le altezze delle soglie, gli impluvi, la dimensione delle ceramiche e la tipologia di supporto, si otterranno, oltre all'indicazione della tipologia più adatta e alla quantificazione del numero necessario di supporti da impiegare, anche ulteriori dettagli sul numero di lastre intere da posare, quelle da tagliare e molto altro.

Eterno Ivica has developed and made available the innovative "PEDESTAL" software, a program that allows in a simple, fast and precise way, to calculate the number and type of supports necessary to achieve a raised floor according to the shape, geometry and surface of the pavement to be achieved and the type of chosen coating.

Filling in a simple form, where by entering the characteristic data of the work to be performed such as the perimeter of the floor, the heights of the thresholds, the watersheds, the size of the ceramics and the kind of substrate, you will get, in addition to the indication of the most suitable type and quantification of the necessary number of supports to be used, even more details about the number of whole slabs to be laid, the ones to be cut and more.

→ <http://software.eternoivica.it/>

Formazione Training



Sempre al vostro fianco

I consulenti tecnici e commerciali di Eterno Ivica sono sempre a vostra disposizione per consulenze progettuali, applicative e assistenza post-vendita.

Eterno Ivica mette a disposizione di progettisti e posatori una costante azione di aggiornamento, mediante l'organizzazione di corsi di formazione in azienda e, su richiesta, fornendo assistenza in cantiere, per assicurare i migliori risultati di posa in opera.

I corsi di formazione verranno organizzati e comunicati attraverso il nostro sito.

Always by your side

The technical and commercial consultants of Eterno Ivica are always at your disposal for advice design, application and service after-sales.

Eterno Ivica makes available to designers and installers constant updating by the organization of training courses in the company and on request providing assistance at the construction site, to ensure the best results of laying.

The training courses will be managed and communicated through our site.

Assistenza in cantiere

Assistance on site



L'attività di assistenza tecnica in cantiere condotta dal nostro personale consiste nell'effettuare costanti visite tecniche presso i cantieri in essere.

Allo scopo di individuare e segnalare le irregolarità relative alla posa in sicurezza, forniamo alle imprese e ai lavoratori le opportune indicazioni volte a eliminare qualsiasi dubbio riguardante la posa in opera dei nostri supporti per pavimentazioni sopraelevate da esterno.

In uno spirito di collaborazione con imprese e artigiani, vengono individuate e consigliate le misure per un'efficiente e veloce posa in tutta sicurezza.

The on-site technical assistance activity consists in constant visits carried out by our staff.

In order to identify and report irregularities relating to a safety installation, we provide all the informations needed regarding the installation of our supports for outdoor raised flooring to companies and installers.

In a spirit of collaboration with companies and artisans, the steps for an efficient and a quick safety installation are identified and recommended.

Scuola di posa

Installation school



La formazione e la didattica sono pilastri della mission di Eterno Ivica, valori che si concretizzano nell'organizzazione periodica di seminari e corsi di approfondimento tecnico-formativo in tutti gli ambiti edilizi che l'azienda concerne. La scuola di posa nasce per affiancare e dare supporto ad artigiani e posatori che si affacciano al mondo del sopraelevato per impararne i "trucchi del mestiere". Offriamo così corsi pratici e seminari tecnici per posatori, anche in collaborazione con Associazione Artigiani. Eterno Ivica crede fortemente nel valore della formazione continua, altamente specializzata, quale strumento per mettere i professionisti e gli operatori del settore in grado di rispondere efficacemente alle continue necessità e richieste del mercato.

Training and teaching are the pillars of Eterno Ivica's mission, a value that is embodied with the periodic organization of seminars and technical-training courses in all the building sectors related to the company. The installation school was created to assist and support craftsmen and installers who just enter in the world of the raised floor to learn the "tricks of the trade". We offer practical courses and technical seminars to the installers, in collaboration with Associazione Artigiani. Eterno Ivica strongly believes in the value of continuously and highly specialized training as a tool to make professionals and installers capable of responding effectively to the continuous needs and demands of the market.

Confezioni speciali personalizzate



Esempio di scatola personalizzata con le informazioni sul prodotto.

Example of box with personalized product information.

I supporti della gamma SE (SE0 - SE1 - SE2 - SE3) e NM (NM1 - NM2 - NM3) possono essere forniti, su richiesta, in appositi imballaggi di cartone contenenti dieci supporti. Le scatole sono completamente graficizzate e riportano esaustive e dettagliate informazioni sul prodotto, sulle modalità di impiego e sulla posa.

I supporti Star.T e le Prolunghe Star.T sono forniti in imballi di cartone da 20 unità cadauno, su cui è apposta un'etichetta riportante le informazioni sul prodotto e la posa.

The supports of the SE range (SE0 - SE1 - SE2 - SE3) and NM (NM1 - NM2 - NM3) can be provided, on request, in special cardboard packaging containing ten supports. The boxes are fully graphed and report comprehensive and detailed product information, on how to use and how to install them.

The Star.T and Star.T Extension supports are supplied in bags of 20 units each, that also bear a label showing the product information and installation.



Customized special packages



Contiene n. 10 supporti.

La fornitura dei supporti nelle scatole di cartone da 10 pz. è disponibile a richiesta.

It contains n. 10 supports.

The supply of the supports in cardboard boxes of 10 pcs. is available on request.

Esempio scatola supporti.

Example of box for supports.



Contiene n. 20 supporti.

I supporti Star.T e le Prolunghe Star.T sono forniti in pratici imballi di cartone da 20 pz.

It contains n. 20 supports.

The Star.T and Star.T Extension supports are supplied in practical bags of 20 pcs.

Imballo standard Star.T e prolunga star.T.

Star.T packing standard and star.T extension.

CODICE CODE	TIPO TYPE	QUANTITÀ QUANTITY
E411028038	KIT Supporti SE 0	10
E411037050	KIT Supporti SE 1	10
E411050075	KIT Supporti SE 2	10
E411075120	KIT Supporti SE 3	10
E014025056	KIT Supporti NM 1	10
E014040086	KIT Supporti NM 2	10
E014060116	KIT Supporti NM 3	10

Referenze

References





Averanda - Passaggi pedonali e camminamenti
Cuernavaca, Messico
Pedestal System - Eterno SE

Averanda - Walkways
Cuernavaca, Mexico
Pedestal System - Eterno SE



Metropolitan Museum of Art – Temporary Roof Garden
 New York, U.S.A.
 Pedestal System – Eterno SE

Metropolitan Museum of Art – Temporary Roof Garden
New York, U.S.A.
Pedestal System – Eterno SE



MICA (Middle of Campbell) – Rooftop, terrazze e aree esterne
 Campbell, Australia
 Pedestal System – New Maxi NM

MICA (Middle of Campbell) – Rooftop, terraces and external areas
 Campbell, Australia
 Pedestal System – New Maxi NM

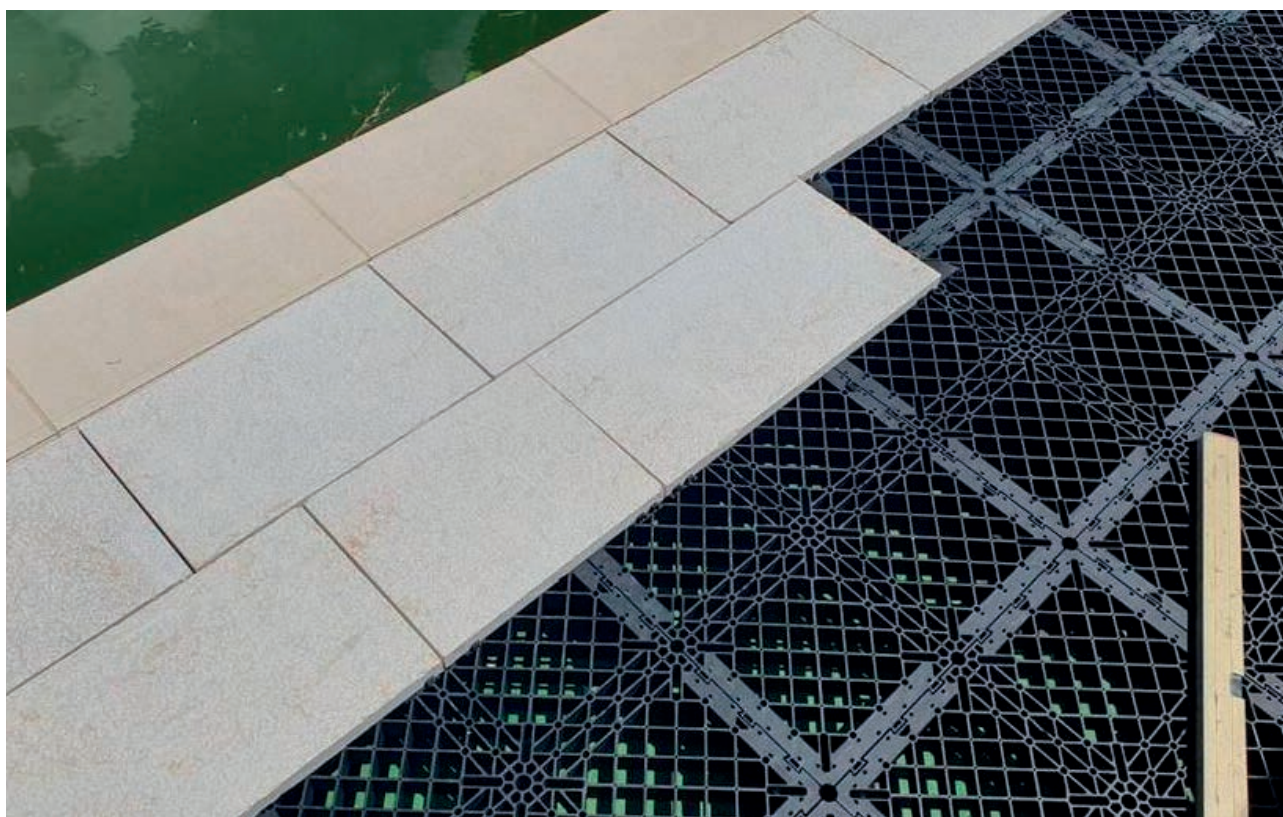

Villa privata – Bordo piscina

Tribunj, Croazia
GRF System – Eterno SE

Private villa – Pool side

Tribunj, Croatia
GRF System – Eterno SE



Edificio residenziale - Rooftop, terrazze e aree esterne
 Pforzheim, Germania
 GRF System - Eterno SE

Residential area - Rooftop, terraces and external areas
 Pforzheim, Germany
 GRF System - Eterno SE

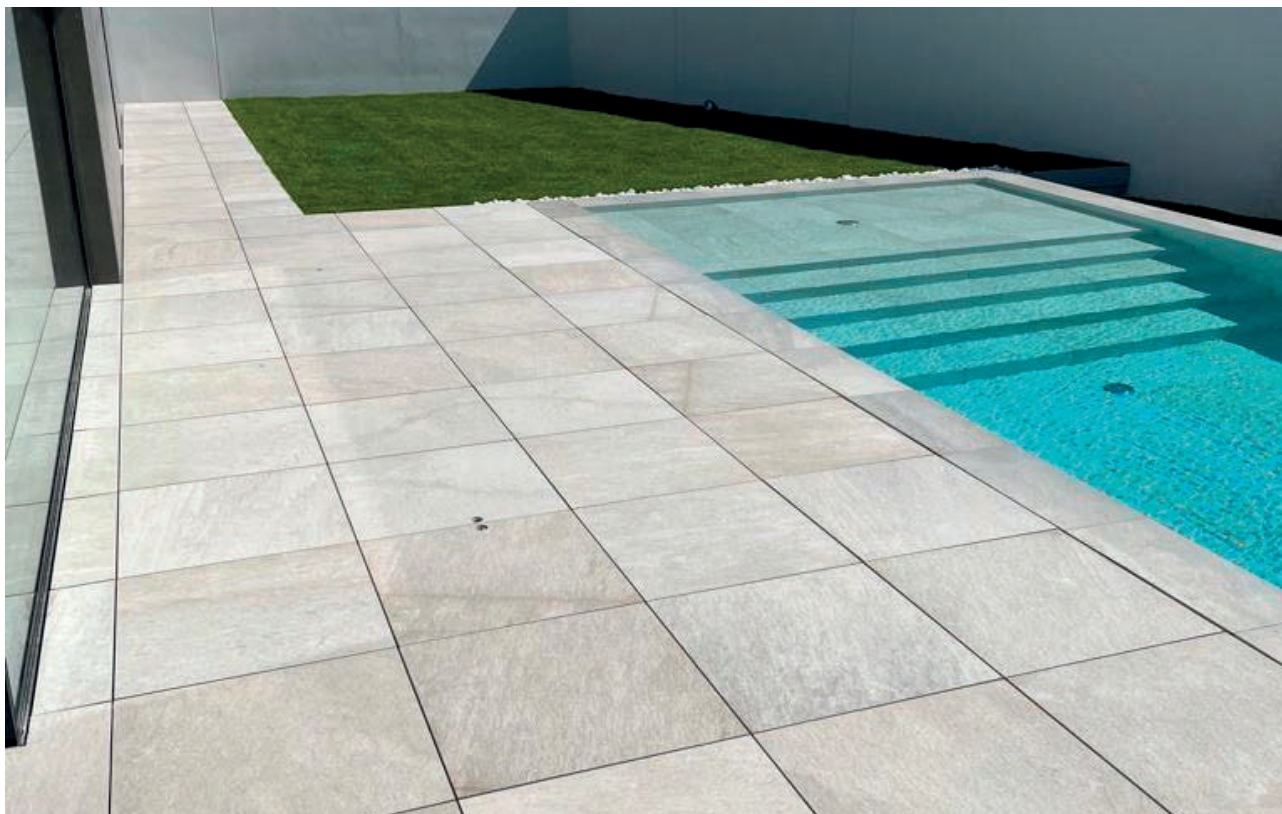

Villa privata – Bordo piscina
 Jesolo (VE), Italia
 GRF System – Pedestal Prime®

Private villa – Pool side
 Jesolo (VE), Italy
 GRF System – Pedestal Prime®



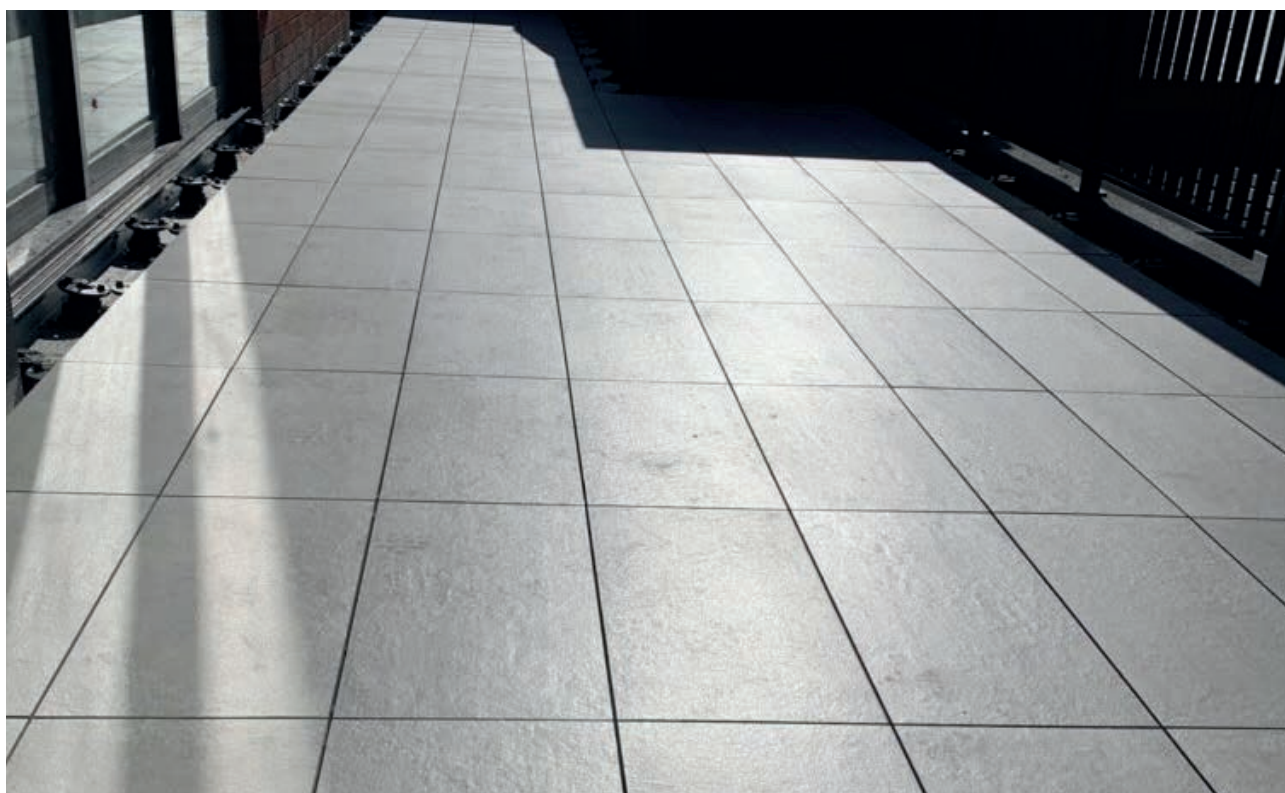

Clifton Crescent Mount Lawley – Rooftop, terrazze e aree esterne

Perth, Australia
Pedestal System – Basic SB

Clifton Crescent Mount Lawley – Rooftop, terraces and external areas

Perth, Australia
Pedestal System – Basic SB



Villa privata – Rooftop, terrazze e aree esterne
Folgaria (TN), Italia
Pedestal System – Eterno SE e Star.T

Private villa – Rooftop, terraces and external areas
Folgaria (TN), Italy
Pedestal System – Eterno SE and Star.T





Bosco Verticale – Rooftop, terrazze e aree esterne
Milano, Italia
Pedestal System – Eterno SE

Vertical Forest – Rooftop, terraces and external areas
Milan, Italy
Pedestal System – Eterno SE



Dominion Apartments – Rooftop, terrazze e aree esterne
 Canberra, Australia
 Pedestal System – New Maxi NM

Dominion Apartments – Rooftop, terraces and external areas
 Canberra, Australia
 Pedestal System – New Maxi NM



Penthouse – Rooftop, terrazze e aree esterne
 Seul, Corea del Sud
 Pedestal System – Pedestal Prime®

Penthouse – Rooftop, terraces and external areas
 Seul, South Korea
 Pedestal System – Pedestal Prime®



A Matter of Perception
Installazione di Diébédo Francis Kéré
 Palazzo Litta, Milano, Italia
 Woodeck System – Eterno SE

A Matter of Perception
Temporary exhibition by Diébédo Francis Kéré
 Palazzo Litta, Milan, Italy
 Woodeck System – Eterno SE



Tempietto nel bosco - Installazione di Asif Khan
Palazzo Litta, Milano, Italia
Woodeck System - New Maxi NM

Tempietto nel bosco - Temporary exhibition by Asif Khan
Palazzo Litta, Milan, Italy
Woodeck System - New Maxi NM

Marina Bay Sands - Rooftop, terrazze e aree esterne
Singapore
Woodeck System - Eterno SE

Marina Bay Sands - Rooftop, terraces and external areas
Singapore
Woodeck System - Eterno SE







Gorky Park – Passaggi pedonali e camminamenti
Mosca, Russia

Pedestal System – Eterno SE

Gorky Park – Walkways
Moscow, Russia

Pedestal System – Eterno SE



Up-site – Rooftop, terrazze e aree esterne
Bruxelles, Belgio

Pedestal System – New Maxi NM

Up-site – Rooftop, terraces and external areas
Brussels, Belgium

Pedestal System – New Maxi NM

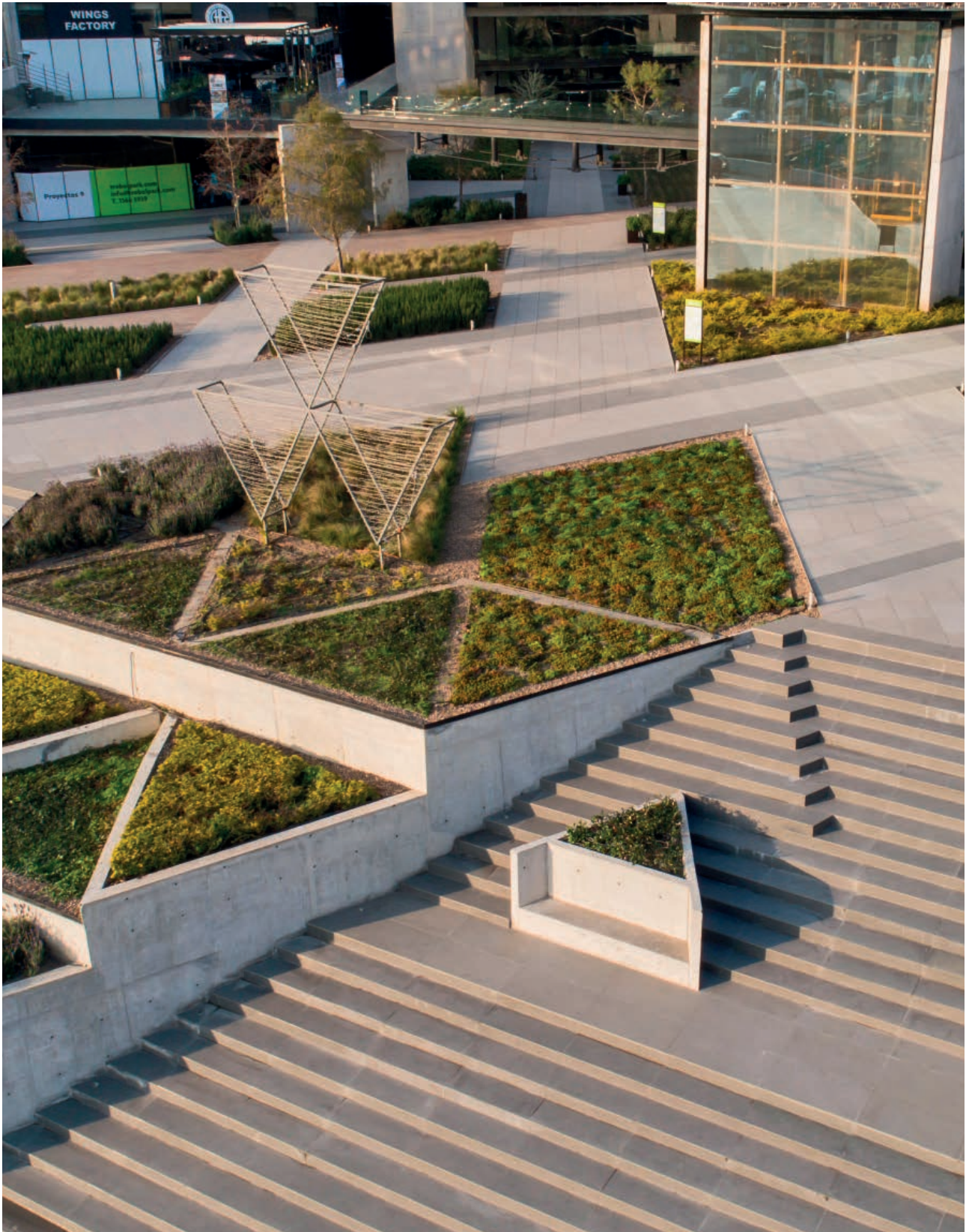
**Trebol - Passaggi pedonali e camminamenti**

Monterrey, Messico
Pedestal System - New Maxi NM

Trebol - Walkways

*Monterrey, Mexico
Pedestal System - New Maxi NM*



Politecnico di Milano – Passaggi pedonali e camminamenti
 Milano, Italia
 Woodeck System – New Maxi NM

Politecnico di Milano – Walkways
 Milan, Italy
 Woodeck System – New Maxi NM



Istituto Comprensivo Statale – Rooftop, terrazze
Asiago (VI), Italia
Woodeck System – New Maxi NM

Public School – Rooftop, terraces
Asiago (VI), Italy
Woodeck System – New Maxi NM



Mediterraneo Camping Village – Bordi piscina
Cavallino-Treporti (VE), Italia
Woodeck System – Eterno SE, New Maxi NM, Star.T

Mediterraneo Camping Village – Pool Side
Cavallino-Treporti (VE), Italy
Woodeck System – Eterno SE, New Maxi NM, Star.T

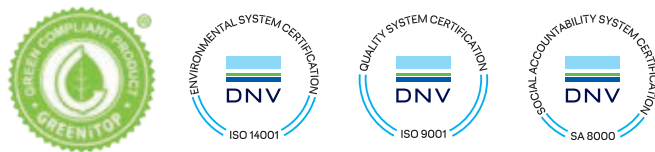

MADE IN ITALY



ETERNO IVICA SRL

via Austria 25 / E
Z.I. Sud - 35127 Padova - Italy

ITA +39 049 8530101
EXP +39 049 8530102
FAX +39 049 8530111

eternoivica@eternoivica.com
www.eternoivica.com



MADE IN ITALY

eternoivica

ETERNO IVICA SRL

via Austria 25 / E
Z.I. Sud - 35127 Padova - Italy

ITA +39 049 8530101
EXP +39 049 8530102
FAX +39 049 8530111

eternoivica@eternoivica.com
www.eternoivica.com